

# HORECA®

EXPERT

PROFESSIONAL EQUIPMENT

20  
23





κατάλογος  
προϊόντων  
επαγγελματικού  
εξοπλισμού  
2023



Στον κατάλόγο μας, κάθε φωτογραφία είδους συνοδεύεται από την περιγραφή του. Ο επαγγελματικός κωδικός που αναγράφεται στην αριστερή στήλη είναι ο κωδικός είδους και σημαίνει ότι το συγκεκριμένο είδος βρίσκεται σε stock στις αποθήκες μας. Η ύπαρξη αστερίσκου (\*) στην αρχή του κωδικού ή εάν δεν υπάρχει καθόλου κωδικός αυτό σημαίνει ότι το είδος δεν είναι ετοιμοπαράδοτο αλλά μπορεί να παραγγελθεί ειδικά για εσάς στο εργοστάσιο. Σε αρκετά προϊόντα, κάτω από τον κωδικό αναγράφεται και ο κωδικός εργοστασίου.

- Οι περιγραφές των προϊόντων, λόγω έλλειψης χώρου, είναι συνοπτικές, αλλά περιεκτικές.
- Αναγράφονται οι διαστάσεις του προϊόντος (πλάτος x βάθος | ύψος ή διάμετρος | ύψος) σε cm, η χωρητικότητα σε cl ή lt καθώς και η συσκευασία του προϊόντος.

# ΠΕΡΙΕΧΟΜΕΝΑ - contents

πορσελάνες   chinaware σερβίτσια φαγητού - σερβίτσια καφέ.....	8-121
ποτήρια   glassware.....	122-177
μαχαιροπίρουνα   cutlery.....	178-207
buffet - service.....	208-327
bar - wine - cafe.....	328-377
κουζίνα   kitchenware.....	378-503
συνεδριακός εξοπλισμός   conference.....	504-517
lobby & room service.....	518-538
waste management.....	539-541
έπιπλα εξωτερικών χώρων outdoor furnitures.....	542-547

## *Schonwald*

σερβίτσια φαγητού - σερβίτσια καφέ.....8-35

## *Playground*

σερβίτσια φαγητού - σερβίτσια καφέ.....36-43

## *Heart & Soul*

σερβίτσια φαγητού - σερβίτσια καφέ.....44-49

## *Dudson*

σερβίτσια φαγητού - σερβίτσια καφέ.....50-67

## *Vista Alegre*

σερβίτσια φαγητού - σερβίτσια καφέ.....68-77

## *Gural*

σερβίτσια φαγητού - σερβίτσια καφέ.....78-95

## *Chic*

σερβίτσια φαγητού - σερβίτσια καφέ.....96-97

## *F2D*

σερβίτσια φαγητού - σερβίτσια καφέ.....98-105

## *Genware*

σερβίτσια φαγητού - σερβίτσια καφέ.....106-113

## *Cosy & Trendy*

σερβίτσια φαγητού - σερβίτσια καφέ.....114-117

## *Porline*

σερβίτσια φαγητού - σερβίτσια καφέ.....118-121

*Bormioli Rocco* γυάλινα σερβίτσια.....122-123



# *πορσελάνες - chinaware*



Εμείς στην SCHÖNWALD αναπτύσσουμε και κατασκευάζουμε υψηλής ποιότητας πορσελάνη για περισσότερα από 150 χρόνια. Το πλεονέκτημά μας έγκειται στο ότι πραγματικά γνωρίζουμε καλά την δουδεία μας. Ξέρουμε τις δύσκολες συνθήκες που έχουν να αντιμετωπίσουν τα προϊόντα μας στους σύγχρονους χώρους εστίασης. Και γνωρίζουμε επίσης τις διαφορετικές ανάγκες των πελατών μας και τις απαιτήσεις τους.

Σήμερα, εστιατορές και ξενοδόχοι από εκατό χώρες έχουν αποφασίσει να εξαρτώνται από τις επαγγελματικές λύσεις, την αξιοπιστία και την ποιότητα SCHÖNWALD που κατασκευάζεται στην Γερμανία. Οι συνδρογές μας μεταφράζουν τα διαφορετικά πρόσωπα της σύγχρονης κουζίνας. Από τον παραδοσιακό banquet στο ανεπίσημο finger food, δημιουργούν τις καιάδηδες προτάσεις για ενιεδώς διαφορετικές επιδογές μενού.

Η σαφής εστίαση της SCHÖNWALD στην επαγγελματική πορσελάνη μας επιρέπει να αναπτύξουμε εκπληκτικό εύρος μορφών, σχημάτων και σινδ. Οι πεδάτες μας επιδέγουν αναμεσα σε περισσότερες από 40 εκκυστικές σειρές και 1.700 περίπου μεμονωμένα αντικείμενα.











We have been developing and manufacturing high quality professional porcelain in SCHÖNWALD for over 150 years. No more and no less. The advantage is that we are truly masters of our speciality. We know the tough conditions that our products have to stand up to in food service industry. And we also know our customers' different needs and demands. Restaurants and hoteliers in more than one hundred countries around the world have come to depend on our professional solutions and the reliability of SCHÖNWALD quality made in Germany.













**PERFECT PRESENTATION CALLS FOR THE RIGHT FINGERTIP FEEL**

Our collections translate the diverse faces of modern dining culture into porcelain. From traditional banquet to informal finger food they create a suitable setting for entirely different dining options. SCHÖNWALD's clear focus on professional porcelain allows us to develop an astonishingly diverse range of shapes and styles. Our customers can choose from more than 40 attractive porcelain collections with over 1,700 individual items.

## Shiro



	30.60061 πίατο raised raised plate 17 cm pack: 12	9251217		30.60128 πίατο raised ανάγλυφο raised plate embossed 17 cm pack: 12	9251267
	30.60062 πίατο raised raised plate 21 cm pack: 12	9251221		30.60129 πίατο raised ανάγλυφο raised plate embossed 21 cm pack: 6	9251271
	30.60063 πίατο raised raised plate 24 cm pack: 6	9251224		30.60130 πίατο raised ανάγλυφο raised plate embossed 24 cm pack: 6	9251274
	30.60064 πίατο raised raised plate 26 cm pack: 6	9251226		30.60131 πίατο raised ανάγλυφο raised plate embossed 26 cm pack: 6	9251276
	30.60065 πίατο raised raised plate 28 cm pack: 6	9251228		30.60132 πίατο raised ανάγλυφο raised plate embossed 28 cm pack: 6	9251278

	<b>30.60133</b> 9251309 πίατο βαθύ coupe <i>deep coupe plate</i> 9 cm pack: 12		<b>30.60137</b> 9251365 πίατο βαθύ coupe ανάγλ. <i>deep coupe plate embossed</i> 15 cm pack: 12		<b>30.60066</b> 9251811 πλατό   <i>plateau</i> 11 cm pack: 12
	<b>30.60134</b> 9251321 πίατο βαθύ coupe <i>deep coupe plate</i> 21 cm pack: 6		<b>30.60138</b> 9251371 πίατο βαθύ coupe ανάγλ. <i>deep coupe plate embossed</i> 21 cm pack: 6		<b>30.60067</b> 9251826 πλατό   <i>plateau</i> 26 cm pack: 6
	<b>30.60135</b> 9251326 πίατο βαθύ coupe <i>deep coupe plate</i> 26 cm pack: 6		<b>30.60139</b> 9251376 πίατο βαθύ coupe ανάγλ. <i>deep coupe plate embossed</i> 26 cm pack: 6		<b>30.60141</b> 9252223 πιατέλα οβάλ   <i>oval platter</i> 23,2x16 cm pack: 6
	<b>30.60136</b> 9251328 πίατο βαθύ coupe <i>deep coupe plate</i> 28 cm pack: 6		<b>30.60140</b> 9251378 πίατο βαθύ coupe ανάγλ. <i>deep coupe plate embossed</i> 27,9 cm pack: 6		<b>30.60142</b> 9252230 πιατέλα οβάλ   <i>oval platter</i> 30x19,3 cm pack: 6
					<b>30.60790</b> 9252236 πιατέλα οβάλ   <i>oval platter</i> 36x23,5 cm pack: 6



	<b>30.60143</b> 9256612 μπολ   <i>bowl</i> 27 cl (12 cm) pack: 12		<b>30.60068</b> 9255209 φλιτζάνι espresso <i>espresso cup</i> , 9 cl pack: 12		<b>30.60069</b> 9255220 φλιτζάνι   <i>cup</i> , 20 cl pack: 12
	<b>30.60144</b> 9256615 μπολ   <i>bowl</i> 50 cl (15 cm) pack: 3		<b>30.60147</b> 9256909 πιατάκι   <i>saucer</i> 12,7 cm pack: 12		<b>30.60070</b> 9255226 φλιτζάνι   <i>cup</i> , 26 cl pack: 12
	<b>30.60145</b> 9256619 μπολ   <i>bowl</i> 1 lt (19 cm) pack: 3		<b>30.60148</b> 9256959 πιατάκι ανάγλυφο <i>saucer embossed</i> 12,7 cm pack: 12		<b>30.60071</b> 9256920 πιατάκι   <i>saucer</i> 16,6 cm pack: 12
	<b>30.60146</b> 9256622 μπολ   <i>bowl</i> 1,5 lt (22,1 cm) pack: 3				<b>30.60149</b> 9256970 πιατάκι ανάγλυφο <i>saucer embossed</i> 16,5 cm pack: 12



# Shiro glaze frost

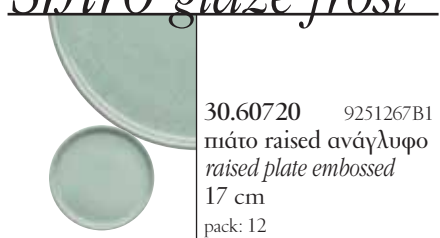

**30.60720** 9251267B1  
 πιάτο raised ανάγλυφο  
*raised plate embossed*  
 17 cm  
 pack: 12

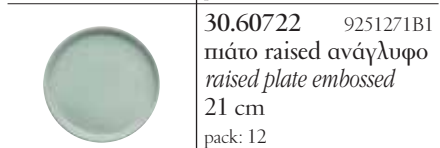

**30.60722** 9251271B1  
 πιάτο raised ανάγλυφο  
*raised plate embossed*  
 21 cm  
 pack: 12



**30.60724** 9251274B1  
 πιάτο raised ανάγλυφο  
*raised plate embossed*  
 24 cm  
 pack: 6



**30.60725** 9251276B1  
 πιάτο raised ανάγλυφο  
*raised plate embossed*  
 26 cm  
 pack: 6

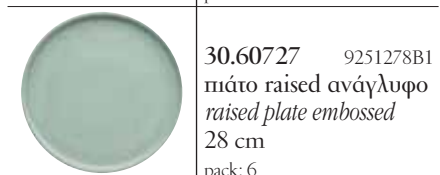

**30.60727** 9251278B1  
 πιάτο raised ανάγλυφο  
*raised plate embossed*  
 28 cm  
 pack: 6



**30.60729** 9251365B1  
 πιάτο βαθύ ανάγλυφο  
*deep coupe plate embossed*  
 15 cm  
 pack: 12



**30.60730** 9251371B1  
 πιάτο βαθύ ανάγλυφο  
*deep coupe plate embossed*  
 21 cm  
 pack: 6



**30.60732** 9251376B1  
 πιάτο βαθύ ανάγλυφο  
*deep coupe plate embossed*  
 26 cm  
 pack: 6



**30.60734** 9251378B1  
 πιάτο βαθύ ανάγλυφο  
*deep coupe plate embossed*  
 28 cm  
 pack: 6



**30.60895** 9252223B1  
 πιατέλα οβάλ  
*oval platter*  
 23,2x16 cm  
 pack: 6

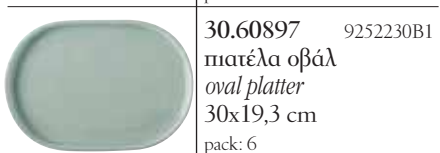

**30.60897** 9252230B1  
 πιατέλα οβάλ  
*oval platter*  
 30x19,3 cm  
 pack: 6



**30.60899** 9252236B1  
 πιατέλα οβάλ  
*oval platter*  
 36x23,5 cm  
 pack: 4

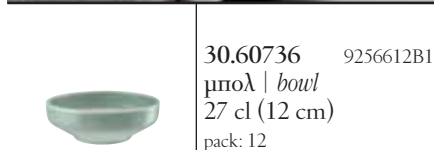

**30.60736** 9256612B1  
 μπολ | bowl  
 27 cl (12 cm)  
 pack: 12

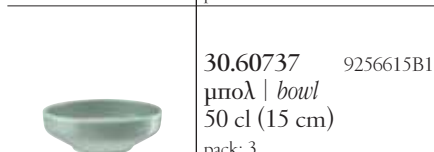

**30.60737** 9256615B1  
 μπολ | bowl  
 50 cl (15 cm)  
 pack: 3

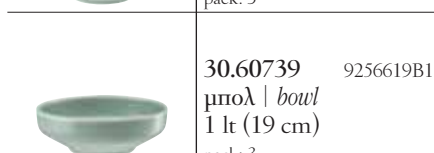

**30.60739** 9256619B1  
 μπολ | bowl  
 1 lt (19 cm)  
 pack: 3

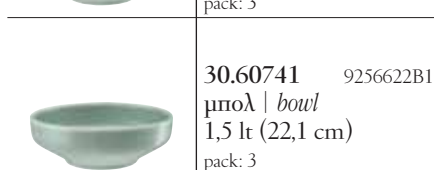

**30.60741** 9256622B1  
 μπολ | bowl  
 1,5 lt (22,1 cm)  
 pack: 3

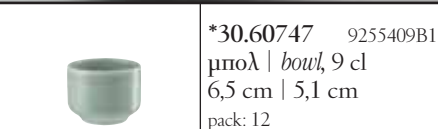

**\*30.60747** 9255409B1  
 μπολ | bowl, 9 cl  
 6,5 cm | 5,1 cm  
 pack: 12

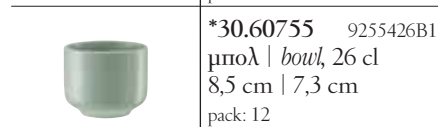

**\*30.60755** 9255426B1  
 μπολ | bowl, 26 cl  
 8,5 cm | 7,3 cm  
 pack: 12

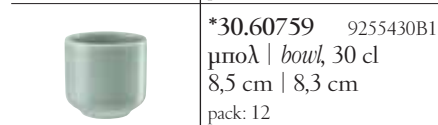

**\*30.60759** 9255430B1  
 μπολ | bowl, 30 cl  
 8,5 cm | 8,3 cm  
 pack: 12

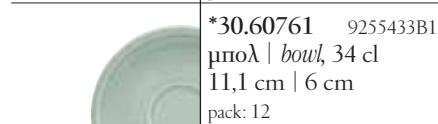











**\*30.60761** 9255433B1  
 μπολ | bowl, 34 cl  
 11,1 cm | 6 cm  
 pack: 12



**30.60751** 9256970B1  
 πιατάκι ανάγλυφο  
*saucer embossed*, 16,5 cm  
 pack: 12



## Shiro glaze steam

	30.60662 9251267A1 πίατο raised ανάγλυφο <i>raised plate embossed</i> 17 cm pack: 12
	30.60721 9251271A1 πίατο raised ανάγλυφο <i>raised plate embossed</i> 21 cm pack: 12
	30.60723 9251274A1 πίατο raised ανάγλυφο <i>raised plate embossed</i> 24 cm pack: 6
	30.60663 9251276A1 πίατο raised ανάγλυφο <i>raised plate embossed</i> 26 cm pack: 6
	30.60726 9251278A1 πίατο raised ανάγλυφο <i>raised plate embossed</i> 28 cm pack: 6
	30.60728 9251365A1 πίατο βαθύ ανάγλυφο <i>deep coupe plate embossed</i> 15 cm pack: 12
	30.60664 9251371A1 πίατο βαθύ ανάγλυφο <i>deep coupe plate embossed</i> 21 cm pack: 6
	30.60731 9251376A1 πίατο βαθύ ανάγλυφο <i>deep coupe plate embossed</i> 26 cm pack: 6
	30.60733 9251378A1 πίατο βαθύ ανάγλυφο <i>deep coupe plate embossed</i> 28 cm pack: 6
	30.60894 9252223A1 πιατέλα οβάλ <i>oval platter</i> 23,2x16 cm pack: 6
	30.60896 9252230A1 πιατέλα οβάλ <i>oval platter</i> 30x19,3 cm pack: 6
	30.60898 9252236A1 πιατέλα οβάλ <i>oval platter</i> 36x23,5 cm pack: 4

	30.60735 9256612A1 μπολ   <i>bowl</i> 27 cl (12 cm) pack: 12
	30.60665 9256615A1 μπολ   <i>bowl</i> 50 cl (15 cm) pack: 3
	30.60738 9256619A1 μπολ   <i>bowl</i> 1 lt (19 cm) pack: 3
	30.60740 9256622A1 μπολ   <i>bowl</i> 1,5 lt (22,1 cm) pack: 3

	*30.60746 9255409A1 μπολ   <i>bowl</i> , 9 cl 6,5 cm   5,1 cm pack: 12
	*30.60754 9255426A1 μπολ   <i>bowl</i> , 26 cl 8,5 cm   7,3 cm pack: 12
	*30.60758 9255430A1 μπολ   <i>bowl</i> , 30 cl 8,5 cm   8,3 cm pack: 12
	*30.60760 9255433A1 μπολ   <i>bowl</i> , 34 cl 11,1 cm   6 cm pack: 12
	30.60749 9256970A1 πιατάκι ανάγλυφο <i>saucer embossed</i> , 16,5 cm pack: 12

*Komodo*



*Shiro glaze decor*

*Rim*









*Kasumi*



## Shiro glaze cafe frost



 <p>30.60744 9255209B1 φλιτζάνι espresso espresso cup, 9 cl pack: 12</p>	 <p>30.60753 9255226B1 φλιτζάνι   cup, 26 cl pack: 12</p>
 <p>30.60745 9256959B1 πιατάκι ανάγλυφο saucer embossed, 12,7 cm pack: 12</p>	 <p>30.60751 9256970B1 πιατάκι ανάγλυφο saucer embossed, 16,5 cm pack: 12</p>
 <p>30.60750 9255220B1 φλιτζάνι   cup, 20 cl pack: 12</p>	 <p>*30.60757 9255230B1 κούπα καφέ coffee mug, 30 cl pack: 6</p>

## Shiro glaze cafe steam



 <p>30.60742 9255209A1 φλιτζάνι espresso espresso cup, 9 cl pack: 12</p>	 <p>30.60752 9255226A1 φλιτζάνι   cup, 26 cl pack: 12</p>
 <p>30.60743 9256959A1 πιατάκι ανάγλυφο saucer embossed, 12,7 cm pack: 12</p>	 <p>30.60749 9256970A1 πιατάκι ανάγλυφο saucer embossed, 16,5 cm pack: 12</p>
 <p>30.60748 9255220A1 φλιτζάνι   cup, 20 cl pack: 12</p>	 <p>*30.60756 9255230A1 κούπα καφέ coffee mug, 30 cl pack: 6</p>

Blue splash





Patching pink

Blends



Pink splash



	<b>30.60043</b> 9120017 πίατο ρηχό   <i>plate</i> 17 cm pack: 12		<b>30.60048</b> 9120125 πίατο βαθύ   <i>deep plate</i> 25 cm pack: 6
	<b>30.60044</b> 9120022 πίατο ρηχό   <i>plate</i> 22 cm pack: 12		<b>30.60049</b> 9120128 πίατο βαθύ   <i>deep plate</i> 28 cm pack: 6
	<b>30.60045</b> 9120026 πίατο ρηχό   <i>plate</i> 26 cm pack: 6		<b>*30.60151</b> 9126428 καπάκι για βαθύ πίατο 28 cm   <i>lid for deep plate 28 cm</i> pack: 1
	<b>30.60046</b> 9120029 πίατο ρηχό   <i>plate</i> 29 cm pack: 6		<b>30.60054</b> 9121321 πίατο coupe βαθύ <i>coupe deep plate</i> 21 cm pack: 6
	<b>30.60047</b> 9120031 πίατο ρηχό   <i>plate</i> 31 cm pack: 6		<b>30.60055</b> 9121326 πίατο coupe βαθύ <i>coupe deep plate</i> 26 cm pack: 6
	<b>30.60050</b> 9121221 πίατο ρηχό coupe <i>coupe flat plate</i> 21 cm pack: 6		<b>*30.60154</b> 9122779 μπολ κονσομέ <i>soup cup</i> , 29 cl pack: 12
	<b>30.60051</b> 9121224 πίατο ρηχό coupe <i>coupe flat plate</i> 24 cm pack: 6		<b>30.60060</b> 9126919 πατάκι   <i>saucer</i> , 16,5 cm pack: 12
	<b>30.60052</b> 9121227 πίατο ρηχό coupe <i>coupe flat plate</i> 27 cm pack: 6		<b>*30.60242</b> 9123165 μπολ σαλάτας <i>salad bowl</i> 43 cl   15 cm pack: 12
	<b>30.60053</b> 9121231 πίατο ρηχό coupe <i>coupe flat plate</i> 31 cm pack: 6		<b>*30.60183</b> 9123168 μπολ σαλάτας <i>salad bowl</i> 90 cl   18 cm pack: 6
	<b>*30.60150</b> 9121229 πίατο ρηχό coupe <i>coupe flat plate</i> 29 cm pack: 6		<b>*30.60155</b> 9126572 μπολ   <i>bowl</i> 22 cl   10,1 cm pack: 12
	<b>30.60053</b> 9121231 πίατο ρηχό coupe <i>coupe flat plate</i> 31 cm pack: 6		<b>*30.60156</b> 9125708 μπολ   <i>bowl</i> 7 cl   8 cm pack: 12
	<b>*30.60157</b> 9122023 πατέλα οβάλ <i>oval platter</i> 23x16,8 cm pack: 12		<b>*30.60152</b> 9124615 φιάλη gourmet <i>gourmet crewet</i> 15 cl   12,9 cm pack: 6
			<b>*30.60162</b> 9124030 αλατιέρα   <i>salt shaker</i> pack: 12
			<b>*30.60163</b> 9124040 πιπεριέρα   <i>pepper</i> pack: 12





**\*30.60160** 9124345  
 τσαγιέρα | *tea pot*  
 45 cl  
 pack: 6



**\*30.60159** 9124130  
 καφετιέρα | *coffee pot*  
 32 cl  
 pack: 6



**\*30.60161** 9124715  
 γαλατιέρα | *creamer*  
 15 cl  
 pack: 6



**30.60056** 9125158  
 φλιτζάνι espresso  
*espresso cup*, 8 cl  
 pack: 12



**30.60059** 9126908  
 πιατάκι | *saucer*, 13,4 cm  
 pack: 12



**30.60058** 9125175  
 φλιτζάνι | *cup*, 25 cl  
 pack: 6



**30.60057** 9125172  
 φλιτζάνι | *cup*, 22 cl  
 pack: 12





**30.60060** 9126919  
 πιατάκι | *saucer*, 16,5 cm  
 pack: 12

# Delight















NOBLE CHINA

	<b>30.61355</b> 9820016 πίατο ρηχό   <i>plate</i> 16 cm pack: 12
	<b>30.61356</b> 9820021 πίατο ρηχό   <i>plate</i> 21 cm pack: 12
	<b>30.61357</b> 9820023 πίατο ρηχό   <i>plate</i> 23 cm pack: 6
	<b>30.61358</b> 9820026 πίατο ρηχό   <i>plate</i> 26 cm pack: 6
	<b>30.61359</b> 9820028 πίατο ρηχό   <i>plate</i> 28 cm pack: 6
	<b>30.61360</b> 9820031 πίατο ρηχό   <i>plate</i> 31 cm pack: 6
	<b>*30.61361</b> 9820120 πίατο βαθύ   <i>deep plate</i> 20 cm pack: 12
	<b>30.61362</b> 9820124 πίατο βαθύ   <i>deep plate</i> 24 cm pack: 6
	<b>30.61363</b> 9820128 πίατο βαθύ   <i>deep plate</i> 28 cm pack: 6
	<b>*30.61364</b> 9821327 πίατο βαθύ coupe <i>deep plate coupe</i> 27 cm pack: 6
	<b>*30.61326</b> 9821331 πίατο βαθύ coupe <i>deep plate coupe</i> 31 cm pack: 6
	<b>*30.61327</b> 9822245 πατέλα οβάλ <i>platter oval</i> 45x20 cm pack: 4
	<b>30.61328</b> 9822619 πατέλα special <i>platter special</i> 19x9 cm pack: 6
	<b>30.61329</b> 9822628 πατέλα special <i>platter special</i> 28x9 cm pack: 12

	<b>*30.61330</b> 9822935 μπολ κονοσομέ <i>soup cup</i> , 35 cl pack: 12
	<b>*30.61353</b> 9826919 πιτάκι   <i>saucer</i> , 16 cm pack: 12
	<b>30.61331</b> 9823063 μπολ   <i>bowl</i> , 13 cm pack: 12
	<b>30.61332</b> 9823166 μπολ   <i>bowl</i> , 16 cm pack: 6

	<b>30.61333</b> 9823170 μπολ   <i>bowl</i> , 20 cm pack: 6
	<b>*30.61346</b> 9826109 μπολ   <i>bowl</i> , 9 cm pack: 6
	<b>*30.61347</b> 9826128 μπολ   <i>bowl</i> , 28 cm pack: 6



	<b>*30.61334</b> 9824130 καφετιέρα με καπάκι <i>coffee pot with lid</i> 30 cl pack: 6		<b>*30.61340</b> 9825319 φλιτζάνι καφέ στοιβ. <i>coffee cup stackable</i> , 19 cl pack: 12		<b>*30.61344</b> 9825278 φλιτζάνι cappuccino <i>cappuccino cup</i> , 28 cl pack: 6
	<b>*30.61335</b> 9824340 τοαγιέρα με καπάκι <i>tea pot with lid</i> 40 cl pack: 6		<b>*30.61341</b> 9825324 φλιτζάνι cappuccino <i>cappuccino cup</i> , 24 cl pack: 12		<b>30.61345</b> 9825285 φλιτζάνι σοκολάτας <i>chocolate cup</i> , 35 cl pack: 12
	<b>*30.61336</b> 9824715 γαλατιέρα   <i>creamer</i> 15 cl pack: 6		<b>*30.61342</b> 9825269 φλιτζάνι καφέ <i>coffee cup</i> , 19 cl pack: 12		<b>30.61350</b> 9826669 μπολ   <i>bowl</i> , 19 cl pack: 12
	<b>*30.61337</b> 9824919 ζαχαριέρα   <i>sugar bowl</i> 19 cl pack: 6		<b>30.61343</b> 9825274 φλιτζάνι τοαγιού <i>tea cup</i> , 24 cl pack: 12		<b>30.61351</b> 9826685 μπολ   <i>bowl</i> , 35 cl pack: 12
	<b>*30.61348</b> 9826649 μπολ/βάση φίλτρου   <i>bowl/stand for tea-strainer</i> , 19 cl pack: 12				<b>30.61353</b> 9826919 πιατάκι   <i>saucer</i> , 16 cm pack: 12





















Vibes

NOBLE CHINA

	<b>30.61682</b> 9820066 πίατο ρηχό   <i>plate</i> 16 cm pack: 12		<b>30.61688</b> 9822245 πιατέλα οβάλ <i>platter oval</i> 34x23 cm pack: 4
	<b>30.61683</b> 9820071 πίατο ρηχό   <i>plate</i> 21 cm pack: 12		<b>30.61338</b> 9825258 φλιτζάνι espresso <i>espresso cup</i> , 8 cl pack: 12
	<b>30.61684</b> 9820078 πίατο ρηχό   <i>plate</i> 28 cm pack: 6		<b>30.61689</b> 9826958 πιατάκι   <i>saucer</i> , 13 cm pack: 12
	<b>30.61685</b> 9820081 πίατο ρηχό   <i>plate</i> 31 cm pack: 6		<b>*30.61342</b> 9825269 φλιτζάνι καφέ <i>coffee cup</i> , 19 cl pack: 12
	<b>30.61686</b> 9820174 πίατο βαθύ   <i>deep plate</i> 24 cm pack: 6		<b>30.61343</b> 9825274 φλιτζάνι τσαγιού <i>tea cup</i> , 24 cl pack: 12
	<b>30.61687</b> 9820178 πίατο βαθύ   <i>deep plate</i> 28 cm pack: 6		<b>*30.61344</b> 9825278 φλιτζάνι cappuccino <i>cappuccino cup</i> , 28 cl pack: 6
			<b>30.61345</b> 9825285 φλιτζάνι σοκολάτας <i>chocolate cup</i> , 35 cl pack: 12
			<b>30.61690</b> 9826969 πιατάκι   <i>saucer</i> , 16 cm pack: 12





# Wellcome



















	<b>*30.60164</b> 9381215 πίατο ρηχό coupe <i>coupe flat plate</i> 15 cm pack: 12
	<b>30.60115</b> 9381222 πίατο ρηχό coupe <i>coupe flat plate</i> 22 cm pack: 6
	<b>30.60116</b> 9381226 πίατο ρηχό coupe <i>coupe flat plate</i> 26 cm pack: 6
	<b>30.60117</b> 9381231 πίατο ρηχό coupe <i>coupe flat plate</i> 31 cm pack: 6
	<b>30.60118</b> 9381316 πίατο βαθύ coupe <i>coupe deep plate</i> 16 cm pack: 6
	<b>30.60119</b> 9381322 πίατο βαθύ coupe <i>coupe deep plate</i> 22 cm pack: 6
	<b>30.60120</b> 9381328 πίατο βαθύ coupe <i>coupe deep plate</i> 28 cm pack: 6
	<b>*30.60165</b> 9021325 πίατο pasta <i>pasta plate</i> 25 cm pack: 6
	<b>30.60124</b> 9383167 μπολ σαλάτας <i>salad bowl</i> 45 cl   17 cm pack: 4
	<b>30.60125</b> 9383174 μπολ σαλάτας <i>salad bowl</i> 125 cl   24,5 cm pack: 1
	<b>30.60123</b> 9383163 μπολ   <i>bowl</i> 33 cl   13 cm pack: 6
	<b>*30.60401</b> 9385709 μπολ   <i>bowl</i> 9 cm   2 cm pack: 24



	<b>*30.60166</b> 9382218 πιατέλα οβάλ <i>oval platter, 18x9 cm</i> pack: 12		<b>*30.60168</b> 9385260 φλιτζάνι espresso <i>espresso cup, 10 cl</i> pack: 12
	<b>30.60121</b> 9382226 πιατέλα οβάλ <i>oval platter, 26x12,6 cm</i> pack: 6		<b>*30.60167</b> 9386910 πιατάκι   <i>saucer, 12,4 cm</i> pack: 12
	<b>30.60122</b> 9382233 πιατέλα οβάλ <i>oval platter, 33x14,1 cm</i> pack: 6		<b>30.60126</b> 9385272 φλιτζάνι χαμηλό <i>tea cup low, 22 cl</i> pack: 12
			<b>*30.60170</b> 9385274 φλιτζάνι τσαγιού <i>tea cup, 24 cl</i> pack: 12
			<b>30.60127</b> 9386918 πιατάκι   <i>saucer, 15,6 cm</i> pack: 12

# Generation





	<b>30.60077</b> 9340016 πίατο ρηχό   <i>plate</i> 16 cm pack: 12		<b>30.60081</b> 9340066 πίατο ρηχό ανάγλυφο <i>flat plate embossed rim</i> 16 cm pack: 12		<b>30.60085</b> 9340123 πίατο βαθύ <i>deep plate</i> 23 cm pack: 6
	<b>30.60078</b> 9340020 πίατο ρηχό   <i>plate</i> 20 cm pack: 12		<b>30.60082</b> 9340070 πίατο ρηχό ανάγλυφο <i>flat plate embossed rim</i> 20 cm pack: 12		<b>30.60086</b> 9340130 πίατο βαθύ <i>deep plate</i> 30 cm pack: 6
	<b>30.60079</b> 9340024 πίατο ρηχό   <i>plate</i> 24 cm pack: 6		<b>30.60083</b> 9340074 πίατο ρηχό ανάγλυφο <i>flat plate embossed rim</i> 24 cm pack: 6		<b>30.60087</b> 9340176 πίατο βαθύ ανάγλυφο <i>deep plate embossed rim</i> 26 cm pack: 6
	<b>30.60080</b> 9340027 πίατο ρηχό   <i>plate</i> 27 cm pack: 6		<b>30.60084</b> 9340077 πίατο ρηχό ανάγλυφο <i>flat plate embossed rim</i> 27 cm pack: 6		<b>30.60088</b> 9340180 πίατο βαθύ ανάγλυφο <i>deep plate embossed rim</i> 30 cm pack: 6
	<b>*30.60184</b> 9340029 πίατο ρηχό   <i>plate</i> 29 cm pack: 6		<b>*30.60187</b> 9340079 πίατο ρηχό ανάγλυφο <i>flat plate embossed rim</i> 29 cm pack: 6		<b>30.60089</b> 9342728 μπολ κονσομέ στοιβ. <i>soup cup stackable, 28 cl</i> pack: 12
	<b>*30.60185</b> 9340031 πίατο ρηχό   <i>plate</i> 31 cm pack: 6		<b>*30.60188</b> 9340081 πίατο ρηχό ανάγλυφο <i>flat plate embossed rim</i> 31 cm pack: 6		<b>30.60098</b> 9346918 πιατάκι   <i>saucer</i> 15,8 cm pack: 12
					<b>30.60100</b> 9346968 πιατάκι ανάγλυφο <i>saucer embossed</i> 15,8 cm pack: 12





# Generation



 \*30.60190 9345372  
μπολ | *bowl*  
22 cl (10 cm)  
pack: 12

 \*30.60191 9345380  
μπολ | *bowl*  
30 cl (11,5 cm)  
pack: 12

 30.60096 9345328  
μπολ στοιβ. | *stack. bowl*  
28 cl (10 cm)  
pack: 12

 30.60090 9343163  
σαλατιέρα | *salad dish*  
31 cl (13 cm)  
pack: 6

 30.60091 9343165  
σαλατιέρα | *salad dish*  
50 cl (15 cm)  
pack: 6

 \*30.60193 9342029  
πιατέλα οβάλ  
*oval platter*  
29,3x22,4 cm  
pack: 6

 \*30.60173 9344010  
αλατιέρα | *salt shaker*  
pack: 12

 \*30.60174 9344020  
πιπεριέρα | *pepper*  
pack: 12

 \*30.60192 9344335  
τοαγιέρα | *tea pot*  
35 cl  
pack: 6

 \*30.60171 9347901  
ζαχαριέρα  
*sugar packet holder*  
10x5,5 cm  
pack: 12

 30.60092 9344715  
γαλατιέρα | *creamer*  
15 cl  
pack: 12

 30.60094 9345260  
φλιτζάνι espresso  
*espresso cup*, 10 cl  
pack: 12

 \*30.60172 9345109  
φλιτζάνι στοιβαζόμενο  
*stackable cup*, 9 cl  
pack: 12

 30.60097 9346909  
πιατάκι | *saucer*, 12,8 cm  
pack: 12















 30.60099 9346959  
πιατάκι ανάγλυφο |  
*saucer embossed*, 12,8 cm  
pack: 12

 30.60095 9345272  
φλιτζάνι τοαγιού  
*tea cup*, 22 cl  
pack: 12

 30.60098 9346918  
πιατάκι | *saucer*, 15,8 cm  
pack: 12

 30.60100 9346968  
πιατάκι ανάγλυφο  
*saucer embossed*, 15,8 cm  
pack: 12







# Form 98 - Form 898

	<b>*30.60177</b> 9010015 πίατο ρηχό   <i>plate</i> 15 cm pack: 12		<b>30.60012</b> 9010028 πίατο ρηχό   <i>plate</i> 28 cm pack: 6		<b>30.60037</b> 9113112 μπολ   <i>salad bowl</i> 12 cm pack: 12
	<b>30.60008</b> 9010017 πίατο ρηχό   <i>plate</i> 17 cm pack: 12		<b>30.60035</b> 9110031 πίατο ρηχό   <i>plate</i> 31 cm pack: 6		<b>30.60038</b> 9113115 μπολ   <i>salad bowl</i> 15 cm pack: 12
	<b>30.60009</b> 9010021 πίατο ρηχό   <i>plate</i> 21 cm pack: 12		<b>30.60013</b> 9010123 πίατο βαθύ   <i>deep plate</i> 23 cm pack: 6		<b>30.60039</b> 9113117 μπολ   <i>salad bowl</i> 17 cm pack: 4
	<b>30.60010</b> 9010024 πίατο ρηχό   <i>plate</i> 24 cm pack: 6		<b>30.60036</b> 9112728 μπολ κονοσομέ στοιβ. <i>soup cup stackable</i> , 26 cl pack: 12		<b>30.60040</b> 9113121 μπολ   <i>salad bowl</i> 21 cm pack: 3
	<b>30.60011</b> 9010026 πίατο ρηχό   <i>plate</i> 26 cm pack: 6		<b>30.60042</b> 9116918 πατάκι   <i>saucer</i> , 14,6 cm pack: 12		<b>*30.60178</b> 9013724 σουπιέρα   <i>tureen</i> 2,4 lt pack: 1

	<b>30.60014</b> 9012021 πιατέλα οβάλ   <i>platter</i> 21,6x14 cm pack: 6
	<b>30.60015</b> 9012026 πιατέλα οβάλ   <i>platter</i> 27,3x17,9 cm pack: 6
	<b>30.60016</b> 9012029 πιατέλα οβάλ   <i>platter</i> 30,3x19,7 cm pack: 6
	<b>30.60017</b> 9012033 πιατέλα οβάλ   <i>platter</i> 34,4x22,7 cm pack: 6
	<b>30.60018</b> 9012038 πιατέλα οβάλ   <i>platter</i> 38,4x25,5 cm pack: 6
	<b>*30.60179</b> 9014001 αυγοθήκη   <i>egg cup</i> pack: 24
	<b>*30.60194</b> 9044001 αυγοθήκη   <i>egg cup</i> pack: 24





	<b>30.60021</b> 9014340 τοαγιέρα   <i>tea pot</i> 40 cl pack: 6
	<b>30.60022</b> 9014380 τοαγιέρα   <i>tea pot</i> 80 cl pack: 6
	<b>30.60020</b> 9014160 καφετιέρα   <i>coffee pot</i> 60 cl pack: 6
	<b>30.60023</b> 9014715 γαλατιέρα   <i>creamer</i> 15 cl pack: 12
	<b>30.60024</b> 9014725 γαλατιέρα   <i>creamer</i> 25 cl pack: 6
	<b>*30.61003</b> 9015650 κούπα   <i>mug</i> 50 cl pack: 6
	<b>30.60031</b> 9016930 πιατάκι   <i>saucer</i> , 16 cm pack: 12











	<b>*30.61000</b> 9015626 κούπα   <i>mug</i> 25 cl pack: 6
	<b>*30.61001</b> 9015630 κούπα   <i>mug</i> 30 cl pack: 6
	<b>*30.61002</b> 9015640 κούπα   <i>mug</i> 40 cl pack: 6
	<b>30.60030</b> 9016927 πιατάκι   <i>saucer</i> , 14,7 cm pack: 12
	<b>30.60033</b> 9025259 φλιτζάνι espresso <i>espresso cup</i> , 9 cl pack: 12
	<b>30.60034</b> 9036909 πιατάκι   <i>saucer</i> , 12 cm pack: 12
	<b>30.60041</b> 9115118 φλιτζάνι στοιβαζόμενο <i>stackable cup</i> , 18 cl pack: 12
	<b>30.60042</b> 9116918 πιατάκι   <i>saucer</i> , 14,6 cm pack: 12

	<b>*30.61004</b> 9015160 φλιτζ espresso χαμηλό <i>espresso cup low</i> 10 cl pack: 12
	<b>*30.60616</b> 9116909 πιατάκι   <i>saucer</i> 14,7 cm pack: 12
	<b>30.60025</b> 9015069 φλιτζάνι   <i>cup</i> 19 cl pack: 12
	<b>30.60026</b> 9015175 φλιτζάνι   <i>cup</i> 25 cl pack: 12
	<b>30.60030</b> 9016927 πιατάκι   <i>saucer</i> 14,7 cm pack: 12
	<b>30.60027</b> 9015180 φλιτζάνι   <i>cup</i> 30 cl pack: 12
	<b>30.60028</b> 9015190 φλιτζάνι   <i>cup</i> 40 cl pack: 12
	<b>30.60031</b> 9016930 πιατάκι   <i>saucer</i> 16 cm pack: 12

# Grace



	*30.60794 9391216 πίατο ρηχό   <i>plate</i> 16 cm pack: 12
	*30.60795 9391221 πίατο ρηχό   <i>plate</i> 21 cm pack: 6
	*30.60796 9391225 πίατο ρηχό   <i>plate</i> 25 cm pack: 6
	*30.60797 9391228 πίατο ρηχό   <i>plate</i> 28 cm pack: 6
	*30.60798 9391232 πίατο ρηχό   <i>plate</i> 32 cm pack: 6
	*30.60799 9391825 πίατο ρηχό (συμβατό με καπάκια πιάτων)   <i>plate (compatible with plate covers)</i> 25 cm pack: 6
	*30.60800 9391828 πίατο ρηχό (συμβατό με καπάκια πιάτων)   <i>plate (compatible with plate covers)</i> 28 cm pack: 6
	*30.60791 9390116 πίατο βαθύ   <i>deep plate</i> 16 cm pack: 12
	*30.60792 9390122 πίατο βαθύ   <i>deep plate</i> 22 cm pack: 12
	*30.60793 9390128 πίατο βαθύ   <i>deep plate</i> 28 cm pack: 6

	<b>*30.60806</b> 9392778 μπολ κονσομέ <i>soup cup</i> , 28 cl pack: 12
	<b>*30.60829</b> 9396918 πιατάκι   <i>saucer</i> , 16,2 cm pack: 12
	<b>*30.60807</b> 9393167 μπολ σαλάτας <i>salad bowl</i> , 16,8 cm pack: 6
	<b>*30.60808</b> 9393170 μπολ σαλάτας <i>salad bowl</i> , 20 cm pack: 6
	<b>*30.60809</b> 9393174 μπολ σαλάτας <i>salad bowl</i> , 24 cm pack: 2
	<b>*30.60823</b> 9396107 μπολ «Calla» <i>bowl «Calla»</i> , 7 cm (2 cl) pack: 12
	<b>*30.60824</b> 9396112 μπολ «Calla» <i>bowl «Calla»</i> , 12 cm (9 cl) pack: 6
	<b>*30.60825</b> 9396115 μπολ «Calla» <i>bowl «Calla»</i> , 15 cm (17 cl) pack: 6
	<b>*30.60822</b> 9395709 ντιπ   <i>dip dish</i> 9,6x9,4 cm (4 cl) pack: 12
	<b>*30.60804</b> 9392622 πιατέλα για τортίγια <i>tortilla platter</i> 22x9,4 cm pack: 12
	<b>*30.60805</b> 9392630 πιατέλα για τортίγια <i>tortilla platter</i> 30x13,5 cm pack: 6





	<b>*30.60810</b> 9394130 καφετιέρα με καπάκι <i>coffee pot with lid</i> 30 cl pack: 6		<b>*30.60814</b> 9395160 φλιτζάνι espresso <i>espresso cup</i> , 10 cl pack: 12
	<b>*30.60811</b> 9394340 τοαγιέρα με καπάκι <i>tea pot with lid</i> 40 cl pack: 6		<b>*30.60828</b> 9396909 πιατάκι   <i>saucer</i> , 14 cm pack: 12
	<b>*30.60812</b> 9394615 γαλατιέρα   <i>creamer</i> 15 cl pack: 6		<b>*30.60815</b> 9395168 φλιτζάνι καφέ <i>coffee cup</i> , 18 cl pack: 12
	<b>*30.60813</b> 9394730 γαλατιέρα   <i>creamer</i> 37 cl pack: 6		<b>*30.60817</b> 9395174 φλιτζάνι καφέ <i>coffee cup</i> , 24 cl pack: 12
	<b>*30.60892</b> 9397901 μπολ για σικς ζάχαρης <i>sugar packet holder</i> 5,6 cm   6,5 cm pack: 12		<b>*30.60816</b> 9395172 φλιτζάνι καφέ/τοαγιού <i>coffee/tea cup</i> , 22 cl pack: 12
			<b>*30.60818</b> 9395178 φλιτζάνι καφέ/τοαγιού <i>coffee/tea cup</i> , 28 cl pack: 12
			<b>*30.60829</b> 9396918 πιατάκι   <i>saucer</i> , 16 cm pack: 12















# Signature



	<p><b>*30.61284</b> 9351217                      πιάτο ρηχό οβάλ  <i>bread plate oval</i>                      17,2x13,1 cm                      pack: 12</p>			
	<p><b>*30.60473</b> 9351222                      πιάτο ρηχό οβάλ  <i>salad plate oval</i>                      22,3x17 cm                      pack: 12</p>			
	<p><b>*30.60474</b> 9351227                      πιάτο ρηχό οβάλ  <i>starter plate oval</i>                      27,3x20,7 cm                      pack: 6</p>			
	<p><b>*30.60476</b> 9351231                      πιάτο ρηχό οβάλ  <i>dinner plate oval</i>                      31,8x24,3 cm                      pack: 6</p>			
	<p><b>*30.61286</b> 9351318                      πιάτο βαθύ οβάλ  <i>deep plate oval</i>                      18,3x13,8 cm                      pack: 12</p>			
	<p><b>*30.61287</b> 9351325                      πιάτο βαθύ οβάλ  <i>deep plate oval</i>                      25,1x19,6 cm                      pack: 6</p>			
	<p><b>*30.61288</b> 9351330                      πιάτο βαθύ οβάλ  <i>deep plate oval</i>                      30,3x23,3 cm                      pack: 6</p>			
	<p><b>*30.60472</b> 9356110                      μπολ - κουτάλι  <i>spoon-shaped bowl</i>                      15,8x9,9 cm                      pack: 12</p>			
	<p><b>*30.60471</b> 9356211                      μπολ οβάλ   <i>bowl oval</i>                      10,9x8,9 cm                      pack: 24</p>			
	<p><b>*30.60470</b> 9356210                      πιατάκι λαδιού  <i>olive oil dish</i>                      9,9x7,4 cm                      pack: 12</p>			
			<p><b>*30.60578</b> 9355257                      φλιτζάνι espresso  <i>espresso cup, 7 cl</i>                      pack: 12</p>	
			<p><b>*30.60613</b> 9356907                      πιατάκι   <i>saucer</i>                      14,1x11,3 cm                      pack: 12</p>	
			<p><b>*30.61290</b> 9355268                      φλιτζάνι   <i>cup, 19 cl</i>                      pack: 12</p>	
			<p><b>*30.60612</b> 9356918                      πιατάκι   <i>saucer</i>                      17,3x13,2 cm                      pack: 12</p>	
			<p><b>*30.60577</b> 9355275                      φλιτζάνι   <i>cup, 24 cl</i>                      pack: 12</p>	
			<p><b>*30.60612</b> 9356918                      πιατάκι   <i>saucer</i>                      17,3x13,2 cm                      pack: 12</p>	
			<p><b>*30.60579</b> 9355280                      κούπα   <i>mug</i>                      30 cl                      pack: 6</p>	



## Showpieces

	*30.61321 9840103 ασύμμετρη πιατέλα 3 θέσεων <i>platter</i> 34,5x23 cm pack: 3
	*30.61432 9840054 πιατέλα παραλ/μη <i>rectang. platter</i> 32x17 cm pack: 6
	*30.61433 9840055 πιατέλα παραλ/μη <i>rectang. platter</i> 36x18 cm pack: 6
	*30.61437 9840060 πιατέλα κυρματιστή <i>curved platter</i> 32,6x23,6 cm pack: 6
	*30.61323 9840105 μπολ hamptons <i>hamptons bowl</i> 16 cm pack: 12
	*30.61325 9840108 μπολ hamptons <i>hamptons bowl</i> 27 cm pack: 3
	*30.61322 9840104 μπολάκι   <i>bowl</i> 14 cm pack: 6
	*30.61324 9840106 μπολ   <i>bowl</i> 18 cm pack: 6
	*30.61434 9840056 μπολ «Chicory»   <i>bowl</i> 13x6,9 cm   5,2 cm pack: 6
	*30.61435 9840057 μπολ «Chicory»   <i>bowl</i> 23,5x11,9 cm   8,1 cm pack: 6
	*30.61436 9840059 μπολ «Chicory»   <i>bowl</i> 20,5x10 cm   9,4 cm pack: 6



# Event



	*30.60336 9320017 πίατο ρηχό   <i>plate</i> 17 cm pack: 12
---	---

	*30.60337 9320020 πίατο ρηχό   <i>plate</i> 20 cm pack: 12
---	---

	*30.61146 9320023 πίατο ρηχό   <i>plate</i> 23 cm pack: 6
---	--

	*30.61147 9320026 πίατο ρηχό   <i>plate</i> 26 cm pack: 6
---	--



	*30.60549 9320028 πίατο ρηχό   <i>plate</i> 28 cm pack: 6
---	--

	*30.61148 9320032 πίατο ρηχό   <i>plate</i> 32 cm pack: 6
--	--

	*30.61145 9320122 πίατο βαθύ   <i>deep plate</i> 22 cm pack: 6
---	---

	*30.60546 9320126 πίατο βαθύ   <i>deep plate</i> 26 cm pack: 6
---	---

	*30.60550 9320130 πίατο βαθύ   <i>deep plate</i> 30 cm pack: 6
---	---

	*30.61384 9322727 μπολ κονοομέ <i>soup cup</i> , 27 cl pack: 12
	*30.60622 9326918 πιατάκι   <i>saucer</i> , 15,9 cm pack: 12

	*30.60543 9323266 μπολ χαμηλό   <i>bowl low</i> 13,8x13,8 cm pack: 6
---	---

	*30.60553 9323290 μπολ χαμηλό   <i>bowl low</i> 33,9x33,9 cm pack: 1
---	---

	*30.60542 9323264 μπολ σαλάτας ψηλό <i>salad bowl tall</i> 11,8x11,8 cm pack: 12
---	--

	*30.61385 9323271 μπολ σαλάτας ψηλό <i>salad bowl tall</i> 17,8x17,8 cm pack: 6
---	---

	*30.60548 9323278 μπολ σαλάτας ψηλό <i>salad bowl tall</i> 23,9x23,9 cm pack: 6
---	---

	*30.60551 9323285 μπολ σαλάτας ψηλό <i>salad bowl tall</i> 30,7x30,7 cm pack: 1
---	---

	*30.60552 9321533 πίατο ρηχό coupe <i>plate coupe</i> 33x33 cm pack: 6
---	--

	*30.60562 9322632 πατέλα slim   <i>platter slim</i> 31,9x17,7 cm pack: 6
---	---

	*30.60836 9322645 πατέλα slim   <i>platter slim</i> 44,8x24,6 cm pack: 6
---	---

	*30.60561 9322229 πατέλα οβάλ <i>platter oval</i> 28,8x12,5 cm pack: 12
---	---

	*30.60837 9322240 πατέλα οβάλ <i>platter oval</i> 40,3x17,8 cm pack: 6
---	--

	*30.60648 9327901 μπολ μαρμελάδας <i>jam jar</i> , 7 cl pack: 6
---	--

	*30.60240 9327910 μπολ dressing <i>dressing bowl</i> , 1 lt pack: 1
---	--

	*30.60496 9304604 γαλατιέρα   <i>creamer</i> 4 cl pack: 24
---	---

	*30.60762 9304715 γαλατιέρα   <i>creamer</i> 15 cl pack: 12
---	--

	*30.61279 9304730 γαλατιέρα   <i>creamer</i> 30 cl pack: 6
---	---

	30.60075 9305159 φλιτζάνι espresso <i>espresso cup</i> , 10 cl pack: 12
---	--

	*30.60614 9306909 πιατάκι   <i>saucer</i> , 13,2 cm pack: 12
---	--

	*30.60586 9305168 φλιτζάνι   <i>cup</i> , 18 cl pack: 12
---	--

	30.60076 9305172 φλιτζάνι   <i>cup</i> , 22 cl pack: 12
---	---

	30.60073 9305118 φλιτζάνι καφέ στοιβ. <i>coffee cup stack.</i> , 18 cl pack: 12
---	--











	30.60074 9305125 φλιτζ. cappuccino στοιβ. <i>cappuccino cup stack.</i> , 25 cl pack: 12
---	---





	*30.60622 9306918 πιατάκι   <i>saucer</i> , 15,6 cm pack: 12
---	--



# Avanti Gusto



	*30.60426 9194704 γαλατιέρα   <i>creamer</i> 4 cl pack: 24
	*30.60425 9194715 γαλατιέρα   <i>creamer</i> 15 cl pack: 12
	*30.60428 9197901 μπολ για φακ. ζάχαρης <i>sugar packet holder</i> 11,4x7,4 cm pack: 12
	*30.60567 9195159 φλιτζάνι espresso <i>espresso cup</i> , 9 cl pack: 12
	*30.60608 9196909 πιατάκι   <i>saucer</i> , 12 cm pack: 12
	*30.60986 9195274 φλιτζάνι καφέ <i>coffee cup</i> , 24 cl pack: 12
	*30.60609 9196918 πιατάκι   <i>saucer</i> , 16 cm pack: 12
	*30.60566 9195109 φλιτζάνι espresso στοιβ. <i>espresso cup stack.</i> , 9 cl pack: 12
	*30.60608 9196909 πιατάκι   <i>saucer</i> , 12 cm pack: 12
	*30.60568 9195118 φλιτζάνι καφέ στοιβ. <i>coffee cup</i> , 18 cl pack: 12
	*30.60987 9195125 φλιτζάνι καφέ στοιβ. <i>coffee cup stack.</i> , 25 cl pack: 12
	*30.60609 9196918 πιατάκι   <i>saucer</i> , 16 cm pack: 12



	*30.60431 9190016 πιάτο ρηχό   <i>plate</i> 16 cm pack: 12		*30.60570 9192730 μπολ κονσομέ στοιβ. <i>soup cup, stackable</i> , 28 cl pack: 12
	*30.60432 9190020 πιάτο ρηχό   <i>plate</i> 20 cm pack: 12		30.60609 9196918 πιατάκι   <i>saucer</i> , 16 cm pack: 12
	*30.60433 9190023 πιάτο ρηχό   <i>plate</i> 23 cm pack: 6		*30.60437 9193114 μπολ σαλάτας <i>salad bowl</i> , 14 cm pack: 12
	*30.60434 9190025 πιάτο ρηχό   <i>plate</i> 25 cm pack: 6		*30.60438 9193116 μπολ σαλάτας <i>salad bowl</i> , 16 cm pack: 12
	*30.60435 9190028 πιάτο ρηχό   <i>plate</i> 28 cm pack: 6		*30.60977 9193118 μπολ σαλάτας <i>salad bowl</i> , 18 cm pack: 6
	*30.60974 πιάτο βαθύ (φαρδύ rim) <i>deep plate (wide rim)</i> 24 cm pack: 6		*30.60978 9193810 μπολ βουτύρου <i>butterboat</i> , 10 cl pack: 12
	*30.60975 9190126 πιάτο βαθύ (φαρδύ rim) <i>deep plate (wide rim)</i> 26 cm pack: 6		*30.60441 9192026 πιατέλα οβάλ <i>oval platter</i> 25,6x18,4 cm pack: 6
	*30.60976 9190128 πιάτο βαθύ (φαρδύ rim) <i>deep plate (wide rim)</i> 28 cm pack: 6		*30.60439 9192029 πιατέλα οβάλ <i>oval platter</i> 29,1x20,9 cm pack: 6
			*30.60442 9192032 πιατέλα οβάλ <i>oval platter</i> 32x22,8 cm pack: 6
			*30.60443 9192036 πιατέλα οβάλ <i>oval platter</i> 36x25,9 cm pack: 6



# Connect

	*30.61266 9400016 πίατο ρηχό   <i>plate</i> 16 cm pack: 12		*30.61092 9401328 πίατο βαθύ coupe <i>deep plate coupe</i> 28 cm pack: 6		*30.61395 9405310 μπολ   <i>bowl tall</i> 10 cm   7,2 cm pack: 12
	*30.61267 9400022 πίατο ρηχό   <i>plate</i> 22 cm pack: 6		*30.61268 9400116 πίατο ρηχό gourmet <i>gourmet plate</i> 16 cm pack: 12		*30.61036 9405318 μπολ   <i>bowl tall</i> 17,5 cm   9,3 cm pack: 12
	*30.61093 9400024 πίατο ρηχό   <i>plate</i> 24 cm pack: 6		*30.60995 9400130 πίατο ρηχό gourmet <i>gourmet plate</i> 30 cm pack: 6		*30.61402 9402225 πιατέλα coupe <i>platter coupe oval</i> 25x15,4 cm pack: 6
	*30.60402 9400027 πίατο ρηχό   <i>plate</i> 27 cm pack: 6		*30.61389 9402878 μπολ κονσομέ <i>soup cup</i> , 32 cl pack: 6		*30.61403 9402229 πιατέλα coupe <i>platter coupe oval</i> 29,2x18 cm pack: 6
	*30.61095 9400029 πίατο ρηχό   <i>plate</i> 29 cm pack: 6		*30.60403 9406918 πιατάκι   <i>saucer</i> , 16 cm pack: 12		*30.61404 9402232 πιατέλα coupe <i>platter coupe oval</i> 32x19,9 cm pack: 6
	*30.61096 9400032 πίατο ρηχό   <i>plate</i> 32 cm pack: 6		*30.61390 9403164 μπολ σαλάτας <i>salad bowl</i> , 14,5 cm pack: 6		*30.61405 9402238 πιατέλα coupe <i>platter coupe oval</i> 32,8x22 cm pack: 6
	*30.61094 9400626 πίατο ρηχό στενό ριμ <i>plate flat with narrow rim</i> 26 cm pack: 6		*30.61391 9403167 μπολ σαλάτας <i>salad bowl</i> , 17 cm pack: 6		*30.61396 9406220 ραβιέρα οβάλ   <i>bowl oval</i> 20,1x12,6 cm pack: 12
	*30.61386 9401226 πίατο ρηχό coupe <i>plate flat with coupe</i> 26 cm pack: 6		*30.61392 9403170 μπολ σαλάτας <i>salad bowl</i> , 19,7 cm pack: 6		*30.61397 9406225 ραβιέρα οβάλ   <i>bowl oval</i> 25,1x15,9 cm pack: 6
	*30.61198 9401228 πίατο ρηχό coupe <i>plate flat with coupe</i> 28 cm pack: 6		*30.61393 9403173 μπολ σαλάτας <i>salad bowl</i> , 22,8 cm pack: 6		*30.61398 9115706 μπολ dip   <i>dip dish</i> 6,5 cm pack: 24
	*30.61388 9400124 πίατο βαθύ <i>deep plate</i> 24 cm pack: 6		*30.61394 9405378 μπολ   <i>bowl</i> 11,5 cm   7 cm pack: 6		*30.61281 9115710 μπολ dip   <i>dip dish</i> 9,5 cm pack: 12
	*30.61091 9400128 πίατο βαθύ <i>deep plate</i> 28 cm pack: 6				



	<b>*30.61033</b> 9404130 καφετιέρα με καπάκι <i>coffee pot with lid</i> 30 cl pack: 6
	<b>*30.61034</b> 9404340 τοαγιέρα με καπάκι <i>tea pot with lid</i> 40 cl pack: 6
	<b>*30.61035</b> 9404615 γαλατιέρα   <i>creamer</i> 15 cl pack: 12

	<b>*30.61408</b> 9405260 φλιτζάνι ψηλό <i>cup tall</i> , 10 cl pack: 12
	<b>*30.61407</b> 9406910 πιατάκι   <i>saucer</i> , 12,5 cm pack: 12
	<b>*30.61107</b> 9405268 φλιτζάνι ψηλό <i>cup tall</i> , 22 cl pack: 6
	<b>*30.61106</b> 9405275 φλιτζάνι ψηλό <i>cup tall</i> , 26 cl pack: 6
	<b>*30.60403</b> 9406918 πιατάκι   <i>saucer</i> , 16 cm pack: 6
	<b>*30.61409</b> 9405278 φλιτζάνι   <i>cup</i> , 28 cl pack: 6
	<b>*30.61410</b> 9405285 φλιτζάνι   <i>cup</i> , 35 cl pack: 6
	<b>*30.60403</b> 9406918 πιατάκι   <i>saucer</i> , 16 cm pack: 6

	<b>*30.61411</b> 9405210 φλιτζάνι στοιβ. <i>cup stackable</i> , 9 cl pack: 12
	<b>*30.61407</b> 9406910 πιατάκι   <i>saucer</i> , 12,5 cm pack: 12
	<b>*30.61412</b> 9405218 φλιτζάνι στοιβ. <i>cup stackable</i> , 18 cl pack: 12
	<b>*30.61413</b> 9405225 φλιτζάνι στοιβ. <i>cup stackable</i> , 24 cl pack: 12
	<b>*30.60403</b> 9406918 πιατάκι   <i>saucer</i> , 16 cm pack: 6
	<b>*30.61414</b> 9405628 κούπα   <i>mug</i> 28 cl pack: 6
	<b>*30.61415</b> 9405528 κούπα στοιβ. <i>mug stackable</i> 28 cl pack: 6

# Shabby chic



Shabby chic 1  
63070



Shabby chic 2  
63071



Shabby chic 3  
63072



Shabby chic 4  
63073

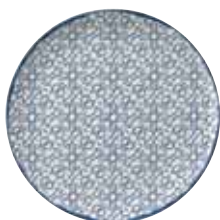

Shabby chic 5  
63074

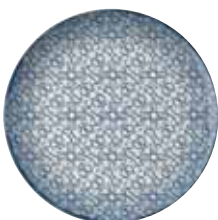

Shabby chic 6  
63075

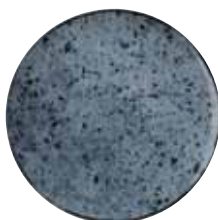

Shabby chic 7  
63076

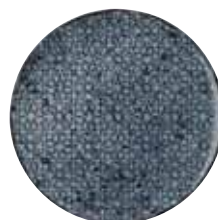

Shabby chic 8  
63077



	<p>πίατο ρηχό coupe <i>flat plate coupe</i> 15 cm 17 cm 20 cm 23 cm 26 cm 28 cm 30 cm 32 cm</p>
	<p>πίατο βαθύ coupe <i>deep plate coupe</i> 21 cm 28 cm</p>
	<p>πιατέλα burger <i>burger platter</i> 36x20 cm</p>
	<p>πίατο ρηχό coupe <i>plate flat coupe square</i> 20,5x20,2 cm 23,8x23,8 cm 27,3x27,3 cm</p>
	<p>πίατο ημιβαθές coupe <i>plate semi deep coupe square</i> 12x12 cm 16,6x16,6 cm 23,8x23,8 cm</p>
	<p>πιατέλα sushi <i>sushi platter</i> 30,1x10,7 cm</p>
	<p>μπολ ρυζιού <i>rice bowl</i> 12,6 cm (34 cl)</p>
	<p>μπολ <i>bowl</i> 6,7 cm (7 cl)</p>
	<p>σαλατιέρα <i>salad dish</i> 16 cm 18 cm</p>
	<p>φλιτζάνι espresso 9 cl και πιατάκι 11 cm <i>espresso cup 9 cl and saucer 11 cm</i></p>
	<p>φλιτζάνι τσαγιού 19 cl και πιατάκι 13,9 cm <i>tea cup 19 cl and saucer 13,9 cm</i></p>
	<p>φλιτζάνι τσαγιού 25 cl και πιατάκι 13,9 cm <i>tea cup 25 cl and saucer 13,9 cm</i></p>
	<p>κούπα 25 cl <i>mug 25 cl</i></p>













*Shabby chic*





# Hygge



	<p>πίατο ρηχό coupe <i>flat plate coupe</i> 15 cm 17 cm 20 cm 23 cm 26 cm 28 cm 30 cm 32 cm</p>
	<p>πίατο βαθύ coupe <i>deep plate coupe</i> 21 cm 24 cm 28 cm</p>
	<p>πιατέλα burger <i>burger platter</i> 36x20 cm</p>
	<p>πιατέλα οβάλ coupe <i>platter coupe oval</i> 22x14 cm 26,2x17,3</p>
	<p>σαλατιέρα <i>salad dish</i> 16 cm 18 cm</p>
	<p>μπολ ρυζιού <i>rice bowl</i> 12,6 cm (34 cl)</p>
	<p>μπολ <i>bowl</i> 6,7 cm (7 cl)</p>
	<p>μπολ οβάλ <i>bowl oval</i> 20,2x15,6 cm (63 cl) 24,7x18,7 (1,15 lt)</p>
	<p>φλιτζάνι espresso 10 cl και πιατάκι 11 cm <i>espresso cup 10 cl and saucer 11 cm</i></p>
	<p>φλιτζάνι τσαγιού 19 cl και πιατάκι 14,7 cm <i>tea cup 19 cl and saucer 14,7 cm</i></p>
	<p>φλιτζάνι τσαγιού 25 cl και πιατάκι 14,7 cm <i>tea cup 25 cl and saucer 14,7 cm</i></p>
	<p>κούπα 25 cl <i>mug 25 cl</i></p>



Hygge 1  
63118



Hygge 2  
63119



Hygge 3  
63120



Hygge 4  
63121



Hygge 5  
63122



Hygge 6  
63123



Hygge 7  
63124



Hygge 8  
63125

## Nara black (021090)

	πίατο raised <i>raised plate</i>
<b>30.60277</b>	701122191
	21 cm   2,5 cm
	pack: 6
	
<b>30.60278</b>	701122791
	27 cm   2,5 cm
	pack: 6

	μπολ <i>dip dish</i>
<b>30.60691</b>	701350891
	8 cm   5 cm
	pack: 6
	
<b>30.60928</b>	701311291
	12 cm   5,6 cm
	pack: 12
	
<b>*30.60279</b>	701311691
	16 cm   6,2 cm
	pack: 6
	
<b>*30.60634</b>	701312191
	21 cm   7 cm
	pack: 6

	κούπα χωρίς χέρι <i>lug w/o handle</i>
<b>30.60994</b>	701540191
	10 cl (7 cm   6,6 cm)
	pack: 6
	
<b>*30.61013</b>	701540091
	30 cl (8 cm   9,5 cm)
	pack: 6

	<b>*30.61072</b>	701320991
	μπολ ρηχό   <i>bowl flat</i>	
	9x9 cm   2,3 cm	
	pack: 6	

	<b>*30.60692</b>	701321091
	μπολ βαθύ   <i>bowl deep</i>	
	9x9 cm   4,3 cm	
	pack: 6	

	<b>*30.61238</b>	701321891
	μπολ ρηχό   <i>bowl flat</i>	
	18x9 cm   2,3 cm	
	pack: 6	

	<b>*30.61239</b>	701321991
	μπολ βαθύ   <i>bowl deep</i>	
	18x9 cm   4,3 cm	
	pack: 6	

	<b>*30.60654</b>	701218091
	δίσκος ανάγλυφος <i>platter rectang. relief</i>	
	30x18 cm   1,6 cm	
	pack: 6	

## Nara grey (016151)

	πίατο raised ανάγλυφο <i>raised plate relief</i>
<b>*30.60693</b>	701127191
	21 cm   2,5 cm
	pack: 6
	
<b>*30.60289</b>	701127791
	27 cm   2,5 cm
	pack: 6

	μπολ ανάγλυφο <i>dish relief</i>
<b>*30.60712</b>	701355891
	8 cm   5 cm
	pack: 6
	
<b>*30.60710</b>	701316291
	12 cm   5,6 cm
	pack: 12
	
<b>*30.61015</b>	701316691
	16 cm   6,2 cm
	pack: 6
	
<b>*30.60290</b>	701317191
	21 cm   7 cm
	pack: 6

	κούπα χωρίς χέρι ανάγλ. <i>lug w/o handle relief</i>
<b>*30.60291</b>	701545191
	10 cl (7 cm   6,6 cm)
	pack: 6
	
<b>*30.60713</b>	701545091
	30 cl (8 cm   9,5 cm)
	pack: 6

	<b>*30.60286</b>	701320991
	μπολ ρηχό   <i>bowl flat</i>	
	9x9 cm   2,3 cm	
	pack: 6	

	<b>*30.60287</b>	701321091
	μπολ βαθύ   <i>bowl square</i>	
	9x9 cm   4,3 cm	
	pack: 6	





	<b>*30.61062</b>	701321891
	μπολ ρηχό   <i>bowl flat</i>	
	18x9 cm   2,3 cm	
	pack: 6	

	<b>*30.60288</b>	701321091
	μπολ βαθύ   <i>bowl deep</i>	
	18x9 cm   4,3 cm	
	pack: 6	

	<b>*30.60292</b>	701218091
	δίσκος ανάγλυφος <i>platter rectang. relief</i>	
	30x18 cm   1,6 cm	
	pack: 6	

## Nara brown (016150)

	πίατο raised ανάγλυφο <i>raised plate relief</i>
<b>30.60293</b>	701122191
	21 cm   2,5 cm
	pack: 6
	
<b>30.61016</b>	701122791
	27 cm   2,5 cm
	pack: 6

	μπολ ανάγλυφο <i>dish relief</i>
<b>30.61017</b>	701350891
	8 cm   5 cm
	pack: 6
	
<b>*30.61018</b>	701311291
	12 cm   5,6 cm
	pack: 12
	
<b>*30.60294</b>	701311691
	16 cm   6,2 cm
	pack: 6
	
<b>*30.61019</b>	701312191
	21 cm   7 cm
	pack: 6

	κούπα χωρίς χέρι ανάγλ. <i>lug w/o handle relief</i>
<b>*30.60295</b>	701540191
	10 cl (7 cm   6,6 cm)
	pack: 6
	
<b>*30.61020</b>	701540091
	30 cl (8 cm   9,5 cm)
	pack: 6

	<b>*30.60201</b>	701320991
	μπολ ρηχό   <i>bowl flat</i>	
	9x9 cm   2,3 cm	
	pack: 6	

	<b>*30.60202</b>	701321091
	μπολ βαθύ   <i>bowl deep</i>	
	9x9 cm   4,3 cm	
	pack: 6	

	<b>*30.60296</b>	701321891
	μπολ ρηχό   <i>bowl flat</i>	
	18x9 cm   2,3 cm	
	pack: 6	

	<b>*30.61241</b>	701321091
	μπολ βαθύ   <i>bowl deep</i>	
	18x9 cm   4,3 cm	
	pack: 6	













	<b>*30.60653</b>	701218091
	δίσκος ανάγλυφος <i>platter rectang. relief</i>	
	30x18 cm   1,6 cm	
	pack: 6	







## Sea (000351)

	<p>πίατο ρηχό coupe <i>flat plate coupe</i></p> <p>*30.60256 701121591 15 cm   2 cm pack: 6</p>		<p>μπολ ρηχό <i>bowl</i></p> <p>*30.60261 701311491 15 cm   4 cm pack: 6</p>
	<p>*30.60257 701122391 23 cm   3 cm pack: 6</p>		<p>*30.60262 701312091 20 cm   5 cm pack: 6</p>
	<p>*30.60200 701122891 28 cm   3 cm pack: 6</p>		<p>*30.60263 701312391 24 cm   5 cm pack: 6</p>
	<p>μπολ <i>bowl</i></p> <p>*30.60258 701311591 15 cm   5,5 cm pack: 12</p>		<p>πιατέλα βαθιά <i>platter deep</i></p> <p>*30.60264 701212291 22x10 cm   3 cm pack: 6</p>
	<p>*30.60259 701312491 24 cm   7,5 cm pack: 6</p>		<p>*30.60265 701212791 27x12 cm   3 cm pack: 2</p>
	<p>*30.60260 701350991 μπολ dip   <i>dip dish</i> 9 cm   3,5 cm pack: 12</p>		<p>*30.60266 701213691 36x16 cm   3 cm pack: 2</p>

## Glow (191118)

	<p>πίατο ρηχό raised <i>raised plate coupe</i></p> <p>*30.60247 701121591 15 cm   2,2 cm pack: 6</p>
	<p>*30.60248 701122591 25 cm   3,2 cm pack: 6</p>
	<p>*30.60249 701123091 30 cm   3,1 cm pack: 6</p>
	<p>πίατο βαθύ coupe <i>deep plate coupe</i></p> <p>*30.60251 701131891 18 cm   4,1 cm pack: 6</p>
	<p>*30.60252 701132591 25 cm   6,1 cm pack: 6</p>
	<p>*30.60250 701350991 μπολ dip   <i>dip dish</i> 9 cm   2,6 cm pack: 12</p>
	<p>*30.60690 701202691 πιατέλα οβάλ <i>platter oval</i> 26x17 cm   2,8 cm pack: 6</p>













(000436)

(000761)









*Renew*

	πίατο ρηχό raised <i>raised plate</i>			
	30.61577 701122291			
	22 cm			
	pack: 6			
	30.61578 701122891			
	28 cm			
	pack: 6			



	πίατο ρηχό raised <i>raised plate</i>			
	30.61590 701122291			
	22 cm			
	pack: 6			
	30.61591 701122891			
	28 cm			
	pack: 6			

	πιπέλα οβάλ <i>oval platter</i>			
	30.61579 701203091			
	30x18 cm			
	pack: 6			
	30.61580 701203591			
	35x15 cm			
	pack: 6			







	πιπέλα οβάλ <i>oval platter</i>			
	30.61592 701203091			
	30x18 cm			
	pack: 6			
	30.61593 701203591			
	35x15 cm			
	pack: 6			

	μπολ  <i>bowl</i>			
	30.61581 701310991			
	9 cm   3,9 cm			
	pack: 12			
	30.61582 701311491			
	14 cm   5,8 cm			
	pack: 6			
	30.61583 701311791			
	17 cm   6,5 cm			
	pack: 6			
	30.61584 701312191			
	21 cm   7,2 cm			
	pack: 6			

	μπολ  <i>bowl</i>			
	30.61594 701310991			
	9 cm   3,9 cm			
	pack: 12			
	30.61595 701311491			
	14 cm   5,8 cm			
	pack: 6			
	30.61596 701311791			
	17 cm   6,5 cm			
	pack: 6			
	30.61597 701312191			
	21 cm   7,2 cm			
	pack: 6			

	κούπα χωρίς χέρι <i>mug w/o handle</i>			
	*30.61585 701540091			
	30 cl (9 cm   8,2 cm)			
	pack: 6			

	κούπα χωρίς χέρι <i>mug w/o handle</i>			
	*30.61598 701540091			
	30 cl (9 cm   8,2 cm)			
	pack: 6			

	μπολ ανάγλυφο <i>bowl relief</i>			
	30.61586 701315991			
	9 cm   3,9 cm			
	pack: 12			
	30.61587 701316491			
	14 cm   5,8 cm			
	pack: 6			
	30.61588 701316791			
	17 cm   6,5 cm			
	pack: 6			
	30.61589 701317191			
	21 cm   7,2 cm			
	pack: 6			

	μπολ ανάγλυφο <i>bowl relief</i>			
	30.61599 701315991			
	9 cm   3,9 cm			
	pack: 12			
	30.61600 701316491			
	14 cm   5,8 cm			
	pack: 6			
	30.61601 701316791			
	17 cm   6,5 cm			
	pack: 6			
	30.61602 701317191			
	21 cm   7,2 cm			
	pack: 6			





## 2in1 (101793)



πίατο ρηχό/ημιβαθές  
*plate flat/half deep*

\*30.61221 701187191  
21 cm | 3,1 cm  
pack: 1



πίατο ρηχό/βαθύ  
*plate flat/half deep*

\*30.61222 701181691  
16 cm | 4,5 cm  
pack: 1



\*30.61223 701182191  
21 cm | 4,5 cm  
pack: 1



\*30.60677 701182491  
24 cm | 4,5 cm  
pack: 1



μπολ/πλατώ  
*bowl/plateau*

\*30.61224 701341091  
10 cm | 6,9 cm  
pack: 1



\*30.60678 701341691  
16 cm | 8,3 cm  
pack: 1



φλιτζάνι/πλατώ  
*cup/plateau*

\*30.60679 701540191  
6 cm | 5,9 cm (9 cl)  
pack: 6

\*30.61225 01540091  
8 cm | 6,9 cm (20 cl)  
pack: 6



## Silento (001787)



30.69052 701312491  
μπολ | *bowl*  
1,15 lt - 24 cm | 7,5 cm  
pack: 1



30.69053 701312691  
μπολ | *bowl*  
1,4 lt - 26 cm | 7,5 cm  
pack: 1



30.69054 701312891  
μπολ | *bowl*  
1,7 lt - 28 cm | 7,5 cm  
pack: 1

## Stella (008162)



30.60275 701122391  
πίατο raised | *raised plate*  
18 cm | 2,5 cm  
pack: 6



30.60276 701122491  
πίατο raised | *raised plate*  
24 cm | 2,5 cm  
pack: 6



30.60196 701122991  
πίατο raised | *raised plate*  
29 cm | 2,5 cm  
pack: 6

## natural stone



\*30.60210 732340191  
πέτρινο μπολ  
*stonebowl deep*  
11-15 cm | 4-7 cm  
pack: 1



\*30.60332 732260091  
πέτρινο μπολ  
*stonebowl flat*  
16x12,5 cm | 3 cm  
pack: 1



\*30.60333 732350091  
πέτρινο μπολ ντιπ  
*stonebowl dip dish*  
6-9 cm | 3 cm  
pack: 1







### Loft oak

	*30.60326 741890391 ξύλινο σταντ παρα/μο <i>presenter on stand</i> 36x13 cm   10 cm pack: 1
	*30.61064 741890491 ξύλινο σταντ παρα/μο <i>presenter on stand</i> 36x13 cm   19 cm pack: 1
	*30.60937 741890591 ξύλινο σταντ παρα/μο <i>presenter on stand</i> 50x24 cm   10 cm pack: 1



### Loft walnut

	*30.61517 742890391 ξύλινο σταντ παρα/μο <i>presenter on stand</i> 36x13 cm   10 cm pack: 1
	*30.60322 742890491 ξύλινο σταντ παρα/μο <i>presenter on stand</i> 36x13 cm   19 cm pack: 1
	*30.61246 742890591 ξύλινο σταντ παρα/μο <i>presenter on stand</i> 50x24 cm   10 cm pack: 1

\*30.60323 741760191  
βάση παρους. πλάστς  
*rolling pin with recess*  
36 cm | 6,5 cm  
pack: 1



### μαρμάρινα - marble

\*30.60954 731880291  
μαρμάρινο πιατώ  
*marble platter black*  
18x9 cm | 1,1 cm  
pack: 1



\*30.60956 731880391  
μαρμάρινο πιατώ  
*marble platter white*  
18x9 cm | 1,1 cm  
pack: 1



ΝΕΟ  
προϊόν

### Loft wenge

	*30.69057 747890391 ξύλινο σταντ παρα/μο <i>presenter on stand</i> 36x13 cm   10 cm pack: 1
	*30.69065 747890491 ξύλινο σταντ παρα/μο <i>presenter on stand</i> 36x13 cm   19 cm pack: 1



## Avanti wenge

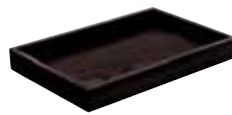

\*30.69056 747890691  
 Ξύλινη βάση παρα/μη  
*menage rectangular*  
 29x19 cm | 3,5 cm  
 pack: 1



\*30.69064 747890291  
 Ξύλινη βάση τετράγ.  
*menage square*  
 18x18 cm | 10,9 cm  
 pack: 1



\*30.69055 747890091  
 Ξύλινη βάση τετράγ.  
*menage square*  
 18x18 cm | 3,4 cm  
 pack: 1



\*30.69058 747880291  
 βάση-οξάρα παρα/μη  
*grid rectangular*  
 18x9 cm | 2 cm  
 pack: 2



\*30.69059 747890191  
 Ξύλινη βάση τετράγ.  
*menage square*  
 18x18 cm | 7,1 cm  
 pack: 1



\*30.69063 747880391  
 βάση-οξάρα τετράγ.  
*grid square*  
 18x18 cm | 2 cm  
 pack: 2

## Avanti walnut



\*30.60639 742890691  
 Ξύλινη βάση παρα/μη  
*menage rectangular*  
 29x19 cm | 3,5 cm  
 pack: 1



\*30.60320 742890291  
 Ξύλινη βάση τετράγ.  
*menage square*  
 18x18 cm | 10,9 cm  
 pack: 1



\*30.60208 742890091  
 Ξύλινη βάση τετράγ.  
*menage square*  
 18x18 cm | 3,4 cm  
 pack: 1



\*30.60321 742880291  
 βάση-οξάρα παρα/μη  
*grid rectangular*  
 18x9 cm | 2 cm  
 pack: 2



\*30.61025 742890191  
 Ξύλινη βάση τετράγ.  
*menage square*  
 18x18 cm | 7,1 cm  
 pack: 1



\*30.60935 742880391  
 βάση-οξάρα τετράγ.  
*grid square*  
 18x18 cm | 2 cm  
 pack: 2

## Avanti oak



\*30.60706 741890691  
 Ξύλινη βάση παρα/μη  
*menage rect. walnut*  
 29x19 cm | 3,5 cm  
 pack: 1



\*30.61027 741890291  
 Ξύλινη βάση τετράγ.  
*menage rect. square*  
 18x18 cm | 10,9 cm  
 pack: 1



\*30.61026 741890091  
 Ξύλινη βάση τετράγ.  
*menage rect. square*  
 18x18 cm | 3,4 cm  
 pack: 1



\*30.61028 741880291  
 βάση-οξάρα παρα/μη  
*grid rect.*  
 18x9 cm | 2 cm  
 pack: 2



\*30.60324 741890191  
 Ξύλινη βάση τετράγ.  
*menage rect. square*  
 18x18 cm | 7,1 cm  
 pack: 1



\*30.60325 741880391  
 βάση-οξάρα τετράγ.  
*grid square*  
 18x18 cm | 2 cm  
 pack: 2

# heart & SOUL

## Εμπνευση

Το νέο brand HEART & SOUL προσφέρει μοντέρνα πιάτα από Vitrified πορσελάνη με μοναδική αισθητική και σχεδιασμό, για όλα τα στυλ, από casual έως fine dining παρουσιάσεις.

## Συμβατότητα Perfect Match

Οι αποχρώσεις του πράσινου, του καφέ και του μπλε που θυμίζουν το μεσογειακό τοπίο, την θάλασσα και την γη, συνδυάζονται αρμονικά μεταξύ τους δίνοντας μια μοναδική αίσθηση στην παρουσίαση των δημιουργιών σας. Η βάρωση της πορσελάνης, δημιουργεί μοναδικά εφέ και προσδίδει στα αντικείμενα μια χειροποίητη όψη. Η συμβατότητα PERFECT MATCH απαρτίζεται από 25 κωδικούς, σε πέντε μοναδικά χρώματα.

## Υψηλών προδιαγραφών παρουσίαση με έντονους και μοναδικούς χρωματισμούς.

Το διπλό ψήσιμο της πορσελάνης σε υψηλή θερμοκρασία 1.200 °C, κάνει τα είδη στιβαρά και αδιάβροχα, διασφαλίζοντας την ανθεκτικότητά τους στη χρήση. Η βάρωση προστατεύει τα χρώματα ώστε να είναι απόλυτα ασφαλή για πλύσεις σε πλυντήριο πιάτων και διατηρεί την υγιεινή των αντικειμένων. Οι κωδικοί με ειδική σήμανση έχουν 5 χρόνια chip warranty.

## See, fall in love, inspire

HEART & SOUL offers trendy chinaware for the food service industry with a unique look and feel. Made by vitrified china for vibrant table settings, perfect match for regional to fine dining food styles.

## Perfect Match collection

The shades of green, brown, and blue which are reminiscent of Mediterranean colors, the sea and the earth, can be combined harmonically leading to a unique feeling to your creations. Reactive glazes make unique effects which make the items one-of-a-kind, having the look of a handcrafted creation. The 25 items from the PERFECT MATCH collection come in five combinable colors.

## Good to know.

HEART & SOUL offers a high-end presentation for your everyday needs, with intense and unique colors. All items are fired twice in high temperature of 1,200 °C which makes them robust and waterproof. The glaze protects the patterns, makes them completely dishwasher safe and also maintains the hygiene of the dishes. All items marked accordingly in the product overview come with a five-year edge impact guarantee.



long dishwasher safe



in stock



stackable



handmade



vitrified



edge impact resistant



fair production



color variance









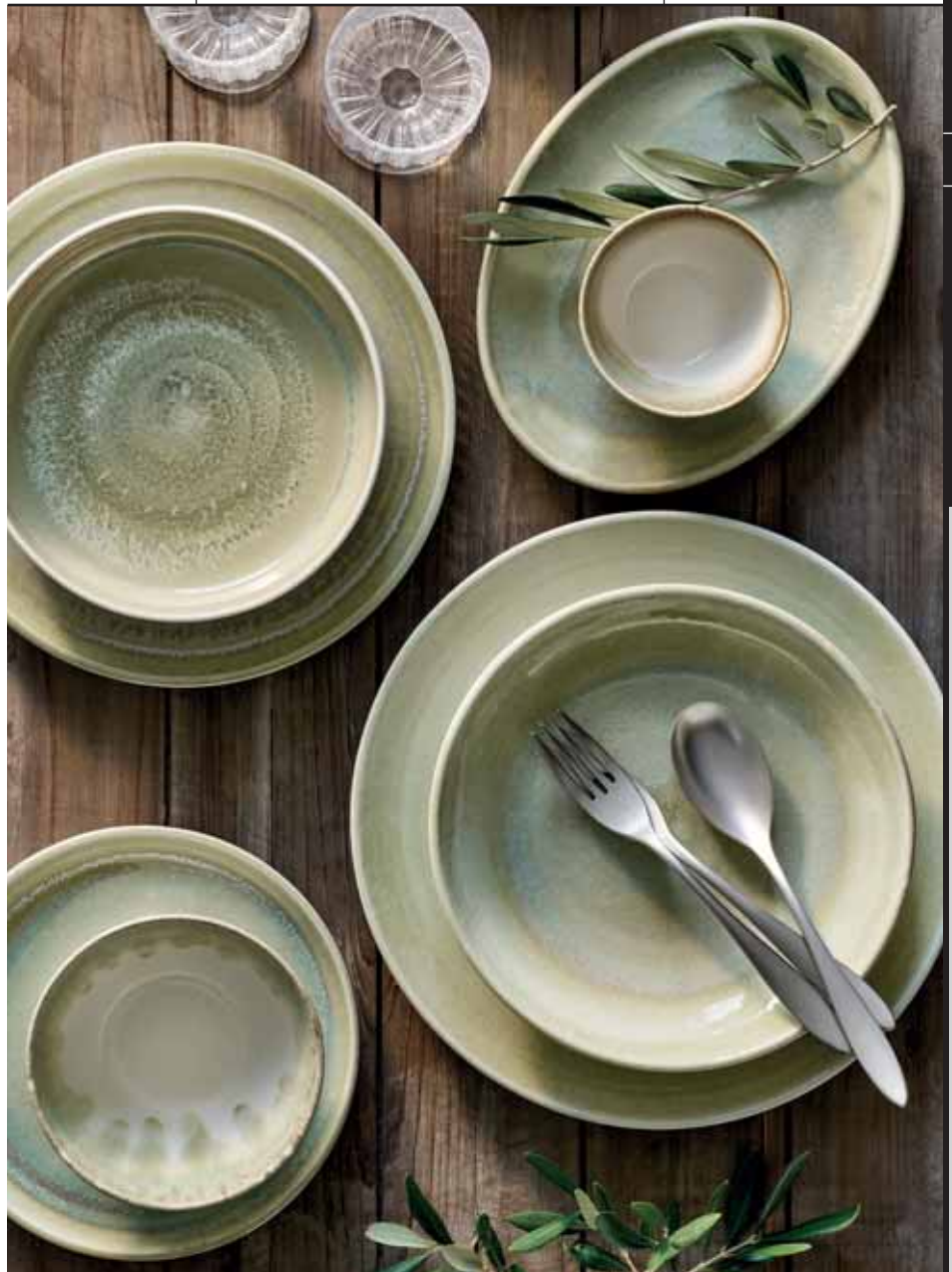















microwave safe & ovenproof

(000104) *Perfect Match thyme*

	*30.69169 801121541 πίατο coupe   coupe plate 15 cm pack: 6		*30.69181 801223641 πιπέλα οβάλ coupe platter oval coupe 36x28 cm pack: 6		*30.69187 801525841 φλιτζάνι   cup, 10 cl pack: 6 *30.69188 801690841 πίατο   saucer 12 cm pack: 6
	*30.69170 801122141 πίατο coupe   coupe plate 21 cm pack: 6		*30.69182 801610841 μπολ   bowl 8 cm pack: 12		*30.69189 801527141 φλιτζάνι   cup, 21 cl pack: 6 *30.69190 801692141 πίατο   saucer 14 cm pack: 6
	*30.69171 801122741 πίατο coupe   coupe plate 27 cm pack: 6		*30.69183 801571041 μπολ   bowl 10 cm pack: 6		*30.69191 801528441 φλιτζάνι   cup, 34 cl pack: 6 *30.69192 801693441 πίατο   saucer 16 cm pack: 6
	*30.69172 801123041 πίατο coupe   coupe plate 30 cm pack: 6		*30.69184 801571441 μπολ   bowl 14 cm pack: 6		*30.69193 801562541 κούπα   mug 25 cl pack: 6
	*30.69173 801132341 πίατο βαθύ coupe coupe deep plate 23 cm pack: 6		*30.69185 801571941 μπολ   bowl 19 cm pack: 6		
	*30.69174 801132841 πίατο βαθύ coupe coupe deep plate 28 cm pack: 6				
	*30.69175 801182141 πίατο raised   plate raised 21 cm pack: 6				
	*30.69176 801182741 πίατο raised   plate raised 27 cm pack: 6				
	*30.69177 801192141 πίατο βαθύ raised raised deep plate 21 cm pack: 4				
	*30.69178 801192441 πίατο βαθύ raised raised deep plate 24 cm pack: 4				
	*30.69179 801222541 πιπέλα οβάλ coupe platter oval coupe 25x19 cm pack: 6				
	*30.69180 801223141 πιπέλα οβάλ coupe platter oval coupe 31x24 cm pack: 6				



# Perfect Match cumin (000102)

























	*30.69119 801121541 πίατο coupe   coupe plate 15 cm pack: 6		*30.69131 801223641 πιατέλα οβάλ coupe platter oval coupe 36x28 cm pack: 6		*30.69137 801525841 φλιτζάνι   cup, 10 cl pack: 6
	*30.69120 801122141 πίατο coupe   coupe plate 21 cm pack: 6		*30.69132 801610841 μπολ   bowl 8 cm pack: 12		*30.69138 801690841 πίατο   saucer 12 cm pack: 6
	*30.69121 801122741 πίατο coupe   coupe plate 27 cm pack: 6		*30.69133 801571041 μπολ   bowl 10 cm pack: 6		*30.69139 801527141 φλιτζάνι   cup, 21 cl pack: 6
	*30.69122 801123041 πίατο coupe   coupe plate 30 cm pack: 6		*30.69134 801571441 μπολ   bowl 14 cm pack: 6		*30.69140 801692141 πίατο   saucer 14 cm pack: 6
	*30.69123 801132341 πίατο βαθύ coupe coupe deep plate 23 cm pack: 6		*30.69135 801571941 μπολ   bowl 19 cm pack: 6		*30.69141 801528441 φλιτζάνι   cup, 34 cl pack: 6
	*30.69124 801132841 πίατο βαθύ coupe coupe deep plate 28 cm pack: 6		*30.69136 801572341 μπολ   bowl 23 cm pack: 6		*30.69142 801693441 πίατο   saucer 16 cm pack: 6
	*30.69125 801182141 πίατο raised   plate raised 21 cm pack: 6				
	*30.69126 801182741 πίατο raised   plate raised 27 cm pack: 6				
	*30.69127 801192141 πίατο βαθύ raised raised deep plate 21 cm pack: 4				
	*30.69128 801192441 πίατο βαθύ raised raised deep plate 24 cm pack: 4				
	*30.69129 801222541 πιατέλα οβάλ coupe platter oval coupe 25x19 cm pack: 6				
	*30.69130 801223141 πιατέλα οβάλ coupe platter oval coupe 25x19 cm pack: 6				

(000101) *Perfect Match oyster*

	*30.69094 801121541 πίατο coupe   coupe plate 15 cm pack: 6		*30.69106 801223641 πιατέλα οβάλ coupe platter oval coupe 36x28 cm pack: 6		*30.69112 801525841 φλιτζάνι   cup, 10 cl pack: 6
	*30.69095 801122141 πίατο coupe   coupe plate 21 cm pack: 6		*30.69107 801610841 μπολ   bowl 8 cm pack: 12		*30.69113 801690841 πίατο   saucer 12 cm pack: 6
	*30.69096 801122741 πίατο coupe   coupe plate 27 cm pack: 6		*30.69108 801571041 μπολ   bowl 10 cm pack: 6		*30.69114 801527141 φλιτζάνι   cup, 21 cl pack: 6
	*30.69097 801123041 πίατο coupe   coupe plate 30 cm pack: 6		*30.69109 801571441 μπολ   bowl 14 cm pack: 6		*30.69115 801692141 πίατο   saucer 14 cm pack: 6
	*30.69098 801132341 πίατο βαθύ coupe coupe deep plate 23 cm pack: 6		*30.69110 801571941 μπολ   bowl 19 cm pack: 6		*30.69116 801528441 φλιτζάνι   cup, 34 cl pack: 6
	*30.69099 801132841 πίατο βαθύ coupe coupe deep plate 28 cm pack: 6		*30.69111 801572341 μπολ   bowl 23 cm pack: 6		*30.69117 801693441 πίατο   saucer 16 cm pack: 6
	*30.69100 801182141 πίατο raised   plate raised 21 cm pack: 6				*30.69118 801562541 κούπα   mug 25 cl pack: 6
	*30.69101 801182741 πίατο raised   plate raised 27 cm pack: 6				
	*30.69102 801192141 πίατο βαθύ raised raised deep plate 21 cm pack: 4				
	*30.69103 801192441 πίατο βαθύ raised raised deep plate 24 cm pack: 4				
	*30.69104 801222541 πιατέλα οβάλ coupe platter oval coupe 25x19 cm pack: 6				
	*30.69105 801223141 πιατέλα οβάλ coupe platter oval coupe 31x24 cm pack: 6				



# Perfect Match avocado (000103)

	*30.69144 801121541 πίατο coupe   coupe plate 15 cm pack: 6		*30.69156 801223641 πιατέλα οβάλ coupe platter oval coupe 36x28 cm pack: 6		*30.69162 801525841 φλιτζάνι   cup, 10 cl pack: 6
	*30.69145 801122141 πίατο coupe   coupe plate 21 cm pack: 6		*30.69157 801610841 μπολ   bowl 8 cm pack: 12		*30.69163 801690841 πίατο   saucer 12 cm pack: 6
	*30.69146 801122741 πίατο coupe   coupe plate 27 cm pack: 6		*30.69158 801571041 μπολ   bowl 10 cm pack: 6		*30.69164 801527141 φλιτζάνι   cup, 21 cl pack: 6
	*30.69147 801123041 πίατο coupe   coupe plate 30 cm pack: 6		*30.69159 801571441 μπολ   bowl 14 cm pack: 6		*30.69166 801528441 φλιτζάνι   cup, 34 cl pack: 6
	*30.69148 801132341 πίατο βαθύ coupe coupe deep plate 23 cm pack: 6		*30.69160 801571941 μπολ   bowl 19 cm pack: 6		*30.69167 801693441 πίατο   saucer 16 cm pack: 6
	*30.69149 801132841 πίατο βαθύ coupe coupe deep plate 28 cm pack: 6		*30.69161 801572341 μπολ   bowl 23 cm pack: 6		*30.69168 801562541 κούπα   mug 25 cl pack: 6
	*30.69150 801182141 πίατο raised   plate raised 21 cm pack: 6				
	*30.69151 801182741 πίατο raised   plate raised 27 cm pack: 6				
	*30.69152 801192141 πίατο βαθύ raised raised deep plate 21 cm pack: 4				
	*30.69153 801192441 πίατο βαθύ raised raised deep plate 24 cm pack: 4				
	*30.69154 801222541 πιατέλα οβάλ coupe platter oval coupe 25x19 cm pack: 6				
	*30.69155 801223141 πιατέλα οβάλ coupe platter oval coupe 31x24 cm pack: 6				



(000100) *Perfect Match breeze*

	*30.69069 801121541 πίατο coupe   coupe plate 15 cm pack: 6		*30.69081 801223641 πιπέλα οβάλ coupe platter oval coupe 36x28 cm pack: 6		*30.69087 801525841 φλιτζάνι   cup, 10 cl pack: 6
	*30.69070 801122141 πίατο coupe   coupe plate 21 cm pack: 6		*30.69082 801610841 μπολ   bowl 8 cm pack: 12		*30.69088 801690841 πίατο   saucer 12 cm pack: 6
	*30.69071 801122741 πίατο coupe   coupe plate 27 cm pack: 6		*30.69083 801571041 μπολ   bowl 10 cm pack: 6		*30.69089 801527141 φλιτζάνι   cup, 21 cl pack: 6
	*30.69072 801123041 πίατο coupe   coupe plate 30 cm pack: 6		*30.69084 801571441 μπολ   bowl 14 cm pack: 6		*30.69090 801692141 πίατο   saucer 14 cm pack: 6
	*30.69073 801132341 πίατο βαθύ coupe coupe deep plate 23 cm pack: 6		*30.69085 801571941 μπολ   bowl 19 cm pack: 6		*30.69091 801528441 φλιτζάνι   cup, 34 cl pack: 6
	*30.69074 801132841 πίατο βαθύ coupe coupe deep plate 28 cm pack: 6		*30.69086 801572341 μπολ   bowl 23 cm pack: 6		*30.69092 801693441 πίατο   saucer 16 cm pack: 6
	*30.69075 801182141 πίατο raised   plate raised 21 cm pack: 6				*30.69093 801562541 κούπα   mug 25 cl pack: 6
	*30.69076 801182741 πίατο raised   plate raised 27 cm pack: 6				
	*30.69077 801192141 πίατο βαθύ raised raised deep plate 21 cm pack: 4				
	*30.69078 801192441 πίατο βαθύ raised raised deep plate 24 cm pack: 4				
	*30.69079 801222541 πιπέλα οβάλ coupe platter oval coupe 25x19 cm pack: 6				
	*30.69080 801223141 πιπέλα οβάλ coupe platter oval coupe 31x24 cm pack: 6				





# Harvest

Αυθεντικά κομμάτια τελειωμένα στο χέρι, αντικατοπτρίζουν τη φιλοσοφία του αγροκτίματος στο τραπέζι. Κάθε κομμάτι είναι ξεχωριστά ναδωμένο στο χέρι φέροντας μια πρωτότυπη σιάμπα από κάτω. Επίσης το πέραςμα του χείδους με καφέ χρώμα να «σιάζει» φυσικά, δημιουργεί στο κάθε προϊόν την μοναδικότητά του. Όλα τα Harvest φτιάχνονται στην Αγγλία με το γνωστό finest vitrified body.

Η συλλογή της Dudson διατίθεται Πανελλαδικά με εξαίρεση τις περιοχές Κέρκυρας, Ηπείρου και Μακεδονίας.

Harvest's genuine hand finished pieces reflect the 'farm-to-table' philosophy. Every piece is individually glazed by hand leaving an original 'makers mark' on the reverse. All pieces also feature a hand finished sponged rim, which naturally drips to create a unique piece. Individuality does not come at the expense of quality. All Harvest products are made in England using the Dudson finest vitrified ceramic body.



## Harvest natural

















	*34.43224 HVNAWP211 πίατο raised raised plate 21 cm   2 cm pack: 6		*34.43202 HVNAEVP81 πίατο ρηχό coupe coupe plate 21,7 cm pack: 12		*34.44228 HVNADU151 πίατο ρηχό coupe organic coupe plate 16,4 cm pack: 12
	*34.43225 HVNAWP261 πίατο raised raised plate 26 cm   2 cm pack: 6		*34.43201 HVNAEV101 πίατο ρηχό coupe coupe plate 26 cm pack: 12		*34.44229 HVNADU231 πίατο ρηχό coupe organic coupe plate 23 cm pack: 12
	*34.43203 HVNAEVP61 πίατο ρηχό coupe coupe plate 16,5 cm pack: 12		*34.43200 HVNAEV111 πίατο ρηχό coupe coupe plate 28,8 cm pack: 12		*34.44230 HVNADU271 πίατο ρηχό coupe organic coupe plate 27,5 cm pack: 12

# Harvest natural

	*34.44231 HVNADU291 πίατο ρηχό coupe <i>organic coupe plate</i> 29 cm pack: 12		*34.44234 HVNADC151 μπολ coupe organic <i>organic coupe bowl</i> 15 cm pack: 12		*34.43211 HVNADR281 πιπέλα ορθογώνια <i>rectangular tray</i> 28,7x19 cm pack: 6
	*34.44232 HVNADU311 πίατο flat <i>organic flat plate</i> 31,8 cm pack: 6		*34.44235 HVNADC201 μπολ coupe organic <i>organic coupe bowl</i> 21 cm pack: 12		*34.43212 HVNADR341 πιπέλα ορθογώνια <i>rectangular tray</i> 34,5x23,3 cm pack: 6
	*34.43205 HVNAEBV71 μπολ coupe <i>coupe bowl</i> 18,2 cm pack: 12		*34.44236 HVNADC251 μπολ coupe organic <i>organic coupe bowl</i> 25 cm pack: 12		*34.43222 HVNASD31 ντιπ   <i>sauce dish</i> 22,7 cl (8 cm   4 cm) pack: 12
	*34.43204 HVNAEBV91 μπολ coupe <i>coupe bowl</i> 24,8 cm pack: 12		*34.44237 HVNADC291 μπολ coupe organic <i>organic coupe bowl</i> 27,9 cm pack: 12		*34.44241 HVNAHBP1 τοαγιέρα/καφετιέρα <i>beverage pot</i> 38 cl pack: 4
	*34.43210 HVNAOGB11 πίατο βαθύ <i>organic bowl</i> 25,3 cm pack: 12		*34.44238 HVNADOB11 πίατο ορθογώνιο <i>organic rectangular plate</i> 27x16 cm pack: 12		*34.44242 HVNAHJG51 γαλιέρα   <i>jug</i> 15 cl pack: 4
	*34.44118 HVNADW291 πίατο βαθύ <i>wobbly bowl</i> 29,5 cm pack: 12		*34.44239 HVNADOB21 πίατο ορθογώνιο <i>organic rectangular plate</i> 34,6x15,6 cm pack: 6		*34.44243 HVNASSGR1 ζαχαριέρα   <i>sugar bowl</i> 22,7 cm pack: 12
	*34.43208 HVNAPD251 πίατο βαθύ coupe <i>deep coupe plate</i> 25,5 cm pack: 12		*34.43206 HVNAXO111 πίατο παραλ/μο <i>chefs' oblong plate</i> 29,8x15,3 cm pack: 12		*34.44244 HVNACB281 cappuccino, 34 cl pack: 12
	*34.43209 HVNAPD271 πίατο βαθύ coupe <i>deep coupe plate</i> 28,1 cm pack: 12		*34.43207 HVNAXO141 πίατο παραλ/μο <i>chefs' oblong plate</i> 35,5x18,9 cm pack: 6		*34.44245 HVNACB201 cappuccino, 22,7 cl pack: 12
	*34.43226 HVNADB171 μπολ βαθύ <i>deep bowl</i> , 47 cl 17,4x14,7 cm pack: 6				*34.44246 HVNACSS 1 πίατο   <i>saucer</i> 15,6 cm pack: 12
	*34.43227 HVNADB201 μπολ βαθύ <i>deep bowl</i> , 51 cl 19,9x16,8 cm pack: 6				*34.44247 HVNACEB91 espresso, 10 cl pack: 12
					*34.44248 HVNAESS1 πίατο   <i>saucer</i> 11,8 cm pack: 12
					*34.44249 HVNAVM121 mug, 34 cl pack: 12



















# Harvest brown

	*34.43313 HVBRWP211 πίατο raised <i>raised plate</i> 21 cm   2 cm pack: 6		*34.43305 HVBREVB71 μπολ coupe <i>coupe bowl</i> 18,2 cm pack: 12
	*34.43314 HVBRWP261 πίατο raised <i>raised plate</i> 26 cm   2 cm pack: 6		*34.43304 HVBREVB91 μπολ coupe <i>coupe bowl</i> 24,8 cm pack: 12
	*34.43303 HVBREVP61 πίατο ρηχό coupe <i>coupe plate</i> 16,5 cm pack: 12		*34.43310 HVBROGB11 πίατο βαθύ <i>organic bowl</i> 25,3 cm pack: 12
	*34.43302 HVBREVP81 πίατο ρηχό coupe <i>coupe plate</i> 21,7 cm pack: 12		*34.43315 HVNADB171 μπολ βαθύ, 47 cl <i>deep bowl</i> 17,4x14,7 cm pack: 6
	*34.43301 HVBREV101 πίατο ρηχό coupe <i>coupe plate</i> 26 cm pack: 12		*34.43316 HVNADB201 μπολ βαθύ, 51 cl <i>deep bowl</i> 19,9x16,8 cm pack: 6
	*34.43300 HVBREV111 πίατο ρηχό coupe <i>coupe plate</i> 28,8 cm pack: 12		*34.43306 HVBRXO111 πατέλα παραλ/μη <i>chefs' oblong plate</i> 29,8x15,3 cm pack: 12
	*34.43308 HVBRPD251 πίατο βαθύ coupe <i>deep coupe plate</i> 25,5 cm pack: 12		*34.43307 HVBRXO141 πατέλα παραλ/μη <i>chefs' oblong plate</i> 35,5x18,9 cm pack: 6
	*34.43309 HVBRPD271 πίατο βαθύ coupe <i>deep coupe plate</i> 28,1 cm pack: 12		*34.43311 HVBRDR281 πατέλα ορθογώνια <i>rectangular tray</i> 28,7x19 cm pack: 6
			*34.43312 HVBRDR341 πατέλα ορθογώνια <i>rectangular tray</i> 34,5x23,3 cm pack: 6



# Harvest mustard

		*34.44250 HVMUWP211 πίατο raised <i>raised plate</i> 21 cm   2 cm pack: 6		*34.44082 HVMUPD271 πίατο βαθύ coupe <i>deep coupe plate</i> 28,1 cm pack: 12
		*34.44251 HVMUWP261 πίατο raised <i>raised plate</i> 26 cm   2 cm pack: 6		*34.44123 HVMUEVB71 μπολ coupe <i>coupe bowl</i> 18,2 cm pack: 12
		*34.44121 HVMUEVP61 πίατο ρηχό coupe <i>coupe plate</i> 16,5 cm pack: 12		*34.44122 HVMUEVB91 μπολ coupe <i>coupe bowl</i> 24,8 cm pack: 12
		*34.44081 HVMUEVP81 πίατο ρηχό coupe <i>coupe plate</i> 21,7 cm pack: 12		*34.44125 HVMUOGB11 πίατο βαθύ <i>organic bowl</i> 25,3 cm pack: 12
		*34.44080 HVMUEV101 πίατο ρηχό coupe <i>coupe plate</i> 26 cm pack: 12		*34.44127 HVMUXO111 πιατέλα παραλ/μη <i>chefs' oblong plate</i> 29,8x15,3 cm pack: 12
		*34.44079 HVMUEV111 πίατο ρηχό coupe <i>coupe plate</i> 28,8 cm pack: 12		*34.44126 HVMUXO141 πιατέλα παραλ/μη <i>chefs' oblong plate</i> 35,5x18,9 cm pack: 6
		*34.44120 HVMUEV121 πίατο ρηχό coupe <i>coupe plate</i> 32,4 cm pack: 12		*34.44129 HVMUDR281 πιατέλα ορθογώνια <i>rectangular tray</i> 28,7x19 cm pack: 6
		*34.44124 HVMUPD251 πίατο βαθύ coupe <i>deep coupe plate</i> 25,5 cm pack: 12		*34.44128 HVMUDR341 πιατέλα ορθογώνια <i>rectangular tray</i> 34,5x23,3 cm pack: 6



handcrafted



5 YEAR  
EDGE CHIP  
WARRANTY



durability



fully glazes foot



stackable



















microwave safe



















dishwasher safe

# Harvest green

	*34.43363 HVGRWP211 πίατο raised <i>raised plate</i> 21 cm   2 cm pack: 6		*34.43355 HVGREVB71 μπολ coupe <i>coupe bowl</i> 18,2 cm pack: 12
	*34.43364 HVGRWP261 πίατο raised <i>raised plate</i> 26 cm   2 cm pack: 6		*34.43354 HVGREVB91 μπολ coupe <i>coupe bowl</i> 24,8 cm pack: 12
	*34.43353 HVGREVP61 πίατο ρηχό coupe <i>coupe plate</i> 16,5 cm pack: 12		*34.43360 HVGROGB11 πίατο βαθύ <i>organic bowl</i> 25,3 cm pack: 12
	*34.43352 HVGREVP81 πίατο ρηχό coupe <i>coupe plate</i> 21,7 cm pack: 12		*34.43365 HVNADB171 μπολ βαθύ, 47 cl <i>deep bowl</i> 17,4x14,7 cm pack: 6
	*34.43351 HVGREV101 πίατο ρηχό coupe <i>coupe plate</i> 26 cm pack: 12		*34.43366 HVNADB201 μπολ βαθύ, 51 cl <i>deep bowl</i> 19,9x16,8 cm pack: 6
	*34.43350 HVGREV111 πίατο ρηχό coupe <i>coupe plate</i> 28,8 cm pack: 12		*34.43356 HVGRXO111 πιατέλα παραλ/μη <i>chefs' oblong plate</i> 29,8x15,3 cm pack: 12
	*34.43358 HVGRPD251 πίατο βαθύ coupe <i>deep coupe plate</i> 25,5 cm pack: 12		*34.43357 HVGRXO141 πιατέλα παραλ/μη <i>chefs' oblong plate</i> 35,5x18,9 cm pack: 6
	*34.43359 HVGRPD271 πίατο βαθύ coupe <i>deep coupe plate</i> 28,1 cm pack: 12		*34.43361 HVGRDR281 πιατέλα ορθογώνια <i>rectangular tray</i> 28,7x19 cm pack: 6
			*34.43362 HVGRDR341 πιατέλα ορθογώνια <i>rectangular tray</i> 34,5x23,3 cm pack: 6



# Harvest linen

	*34.43263 HVLIWP211 πίατο raised <i>raised plate</i> 21 cm   2 cm pack: 6		*34.43255 HVLIEVB71 μπολ coupe <i>coupe bowl</i> 18,2 cm pack: 12
	*34.43264 HVLIWP261 πίατο raised <i>raised plate</i> 26 cm   2 cm pack: 6		*34.43254 HVLIEVB91 μπολ coupe <i>coupe bowl</i> 24,8 cm pack: 12
	*34.43253 HVLIEVP61 πίατο ρηχό coupe <i>coupe plate</i> 16,5 cm pack: 12		*34.43260 HVLIOGB11 πίατο βαθύ <i>organic bowl</i> 25,3 cm pack: 12
	*34.43252 HVLIEVP81 πίατο ρηχό coupe <i>coupe plate</i> 21,7 cm pack: 12		*34.43265 HVNADB171 μπολ βαθύ, 47 cl <i>deep bowl</i> 17,4x14,7 cm pack: 6
	*34.43251 HVLIEV101 πίατο ρηχό coupe <i>coupe plate</i> 26 cm pack: 12		*34.43266 HVNADB201 μπολ βαθύ, 51 cl <i>deep bowl</i> 19,9x16,8 cm pack: 6
	*34.43250 HVLIEV111 πίατο ρηχό coupe <i>coupe plate</i> 28,8 cm pack: 12		*34.43256 HVLIXO111 πίατο παραλ/μο <i>chefs' oblong plate</i> 29,8x15,3 cm pack: 12
	*34.43258 HVLIPD251 πίατο βαθύ coupe <i>deep coupe plate</i> 25,5 cm pack: 12		*34.43257 HVLIXO141 πίατο παραλ/μο <i>chefs' oblong plate</i> 35,5x18,9 cm pack: 6
	*34.43259 HVLIPD271 πίατο βαθύ coupe <i>deep coupe plate</i> 28,1 cm pack: 12		*34.43261 HVLIDR281 πατέλα ορθογώνια <i>rectangular tray</i> 28,7x19 cm pack: 6
			*34.43262 HVLIDR341 πατέλα ορθογώνια <i>rectangular tray</i> 34,5x23,3 cm pack: 6



handcrafted



5 YEAR  
EDGE CHIP  
WARRANTY



durability



fully glazes foot



stackable

















microwave safe



dishwasher safe

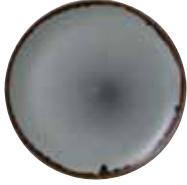





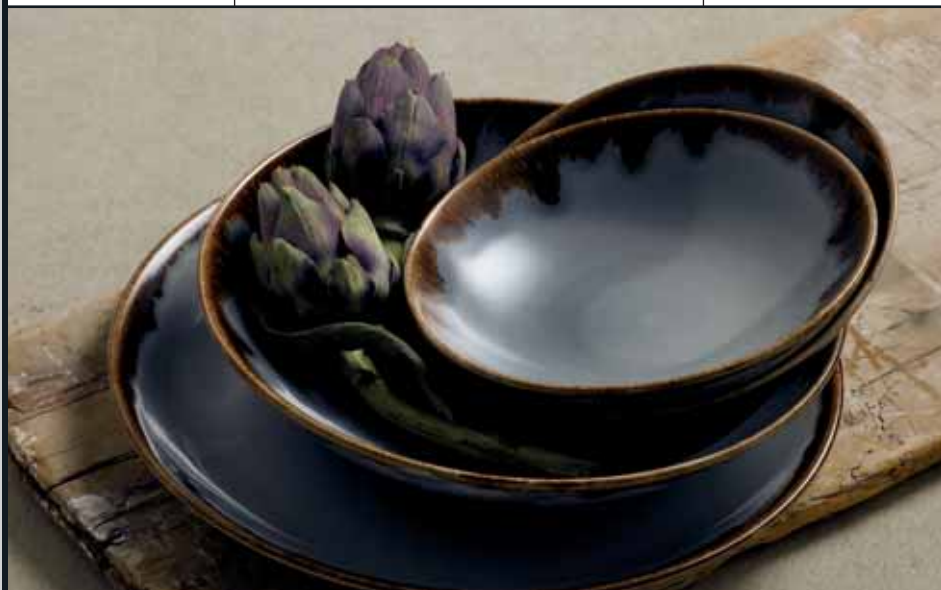









# Harvest grey

	*34.44252 HVGYP211 πίατο raised <i>raised plate</i> 21 cm   2 cm pack: 6		*34.43554 HVGYEB71 μπολ coupe <i>coupe bowl</i> 18,2 cm pack: 12
	*34.44253 HVGYP261 πίατο raised <i>raised plate</i> 26 cm   2 cm pack: 6		*34.43555 HVGYEB91 μπολ coupe <i>coupe bowl</i> 24,8 cm pack: 12
	*34.43553 HVGYEP61 πίατο ρηχό coupe <i>coupe plate</i> 16,5 cm pack: 12		*34.43556 HVGYOB11 πίατο βαθύ <i>organic bowl</i> 25,3 cm pack: 12
	*34.43552 HVGYEP81 πίατο ρηχό coupe <i>coupe plate</i> 21,7 cm pack: 12		*34.43559 HVGYXO111 πατέλα παραλ/μη <i>chefs' oblong plate</i> 29,8x15,3 cm pack: 12
	*34.43551 HVGYEV101 πίατο ρηχό coupe <i>coupe plate</i> 26 cm pack: 12		*34.43560 HVGYXO141 πατέλα παραλ/μη <i>chefs' oblong plate</i> 35,5x18,9 cm pack: 6
	*34.43550 HVGYEV111 πίατο ρηχό coupe <i>coupe plate</i> 28,8 cm pack: 12		*34.43561 HVGYDR281 πατέλα ορθογώνια <i>rectangular tray</i> 28,7x19 cm pack: 6
	*34.43557 HVGYPD251 πίατο βαθύ coupe <i>deep coupe plate</i> 25,5 cm pack: 12		*34.43562 HVGYDR341 πατέλα ορθογώνια <i>rectangular tray</i> 34,5x23,3 cm pack: 6
	*34.43558 HVGYPD271 πίατο βαθύ coupe <i>deep coupe plate</i> 28,1 cm pack: 12		



# Harvest turquoise

	*34.44220 HVTQWP211 πίατο raised <i>raised plate</i> 21 cm   2 cm pack: 6		*34.44223 HVTQDC201 μπολ coupe organic <i>organic coupe bowl</i> 21 cm pack: 12
	*34.44219 HVTQWP261 πίατο raised <i>raised plate</i> 26 cm   2 cm pack: 6		*34.44222 HVTQDC251 μπολ coupe organic <i>organic coupe bowl</i> 25 cm pack: 12
	*34.44216 HVTQVEP61 πίατο ρηχό coupe <i>coupe plate</i> 16,5 cm pack: 12		*34.44221 HVTQDC291 μπολ coupe organic <i>organic coupe bowl</i> 27,9 cm pack: 12
	*34.44215 HVTQVEP81 πίατο ρηχό coupe <i>coupe plate</i> 21,7 cm pack: 12		*34.44227 HVTQDB171 μπολ βαθύ, 47 cl <i>deep bowl</i> 17,4x14,7 cm pack: 6
	*34.44214 HVTQEV101 πίατο ρηχό coupe <i>coupe plate</i> 26 cm pack: 12		*34.44226 HVTQDB201 μπολ βαθύ, 51 cl <i>deep bowl</i> 19,9x16,8 cm pack: 6
	*34.44213 HVTQEV111 πίατο ρηχό coupe <i>coupe plate</i> 28,8 cm pack: 12		*34.44224 HVTQDOB11 πατέλα ορθογώνια <i>organic rectangular tray</i> 27x16 cm pack: 12
	*34.44218 HVTQVEB71 μπολ coupe <i>coupe bowl</i> 18,2 cm pack: 12		*34.44225 HVTQDOB21 πατέλα ορθογώνια <i>organic rectangular tray</i> 34,6x15,6 cm pack: 6
	*34.44217 HVTQVEB91 μπολ coupe <i>coupe bowl</i> 24,8 cm pack: 12		



handcrafted



5 YEAR  
EDGE CHIP  
WARRANTY



durability



fully glazed foot



stackable



microwave safe



dishwasher safe





# Harvest mediterranean

VEO  
nolov



\*34.44270 MEIKDU231  
πίατο ρηχό coupe  
*coupe plate*  
23 cm  
pack: 12



\*34.44271 MEIKDU271  
πίατο ρηχό coupe  
*coupe plate*  
27,5 cm  
pack: 12



\*34.44272 MEIKDU291  
πίατο ρηχό coupe  
*coupe plate*  
29 cm  
pack: 12



\*34.44265 MEIKDC201  
μπολ coupe | *coupe bowl*  
21 cm  
pack: 12



\*34.44266 MEIKDC251  
μπολ coupe | *coupe bowl*  
25 cm  
pack: 12



\*34.44267 MEIKDC291  
μπολ coupe | *coupe bowl*  
27,9 cm  
pack: 12



\*34.44268 MEIKDOB11  
πιπέλα παραλ/μη  
*chefs' oblong plate*  
27x16 cm  
pack: 12



\*34.44269 MEIKDOB21  
πιπέλα παραλ/μη  
*chefs' oblong plate*  
34,6x15,6 cm  
pack: 6



\*34.44264 MEIKESS1  
πίατο | *saucer*  
11,8 cm  
pack: 12



\*34.44263 MEIKCSS1  
πίατο | *saucer*  
15,6 cm  
pack: 12



# Harvest ink



















	*34.44254 HVINWP211 πίατο raised <i>raised plate</i> 21 cm   2 cm pack: 6
	*34.43414 HVINWP261 πίατο raised <i>raised plate</i> 26 cm   2 cm pack: 6
	*34.43503 HVINEVP61 πίατο ρηχό coupe <i>coupe plate</i> 16,5 cm pack: 12
	*34.43502 HVINEVP81 πίατο ρηχό coupe <i>coupe plate</i> 21,7 cm pack: 12
	*34.43501 HVINEV101 πίατο ρηχό coupe <i>coupe plate</i> 26 cm pack: 12
	*34.43500 HVINEV111 πίατο ρηχό coupe <i>coupe plate</i> 28,8 cm pack: 12

	*34.43507 HVINPD251 πίατο βαθύ coupe <i>deep coupe plate</i> 25,5 cm pack: 12
	*34.43508 HVINPD271 πίατο βαθύ coupe <i>deep coupe plate</i> 28,1 cm pack: 12
	*34.43504 HVINEVB71 μπολ coupe <i>coupe bowl</i> 18,2 cm pack: 12
	*34.43505 HVINEVB91 μπολ coupe <i>coupe bowl</i> 24,8 cm pack: 12
	*34.43506 HVINOGB11 πίατο βαθύ <i>organic bowl</i> 25,3 cm pack: 12
	*34.43509 HVINXO111 πιατέλα παραλ/μη <i>chefs' oblong plate</i> 29,8x15,3 cm pack: 12
	*34.43510 HVINXO141 πιατέλα παραλ/μη <i>chefs' oblong plate</i> 35,5x18,9 cm pack: 6
	*34.43511 HVINDR281 πιατέλα ορθογώνια <i>rectangular tray</i> 28,7x19 cm pack: 6
	*34.43512 HVINDR341 πιατέλα ορθογώνια <i>rectangular tray</i> 34,5x23,3 cm pack: 6
	*34.44109 HVINCB281 cappuccino, 34 cl pack: 12
	*34.44110 HVINCSS1 πίατο   saucer 15,6 cm pack: 12
	*34.44111 HVINCEB91 espresso, 10 cl pack: 12
	*34.44112 HVINESS1 πίατο   saucer 11,8 cm pack: 12



# Harvest blue

	*34.43413 HVBLWP211 πίατο raised <i>raised plate</i> 21 cm   2 cm pack: 6		*34.43408 HVBLPD251 πίατο βαθύ coupe <i>deep coupe plate</i> 25,5 cm pack: 12		*34.43415 HVNADB171 μπολ βαθύ, 47 cl <i>deep bowl</i> 17,4x14,7 cm pack: 6
	*34.43414 HVBLWP261 πίατο raised <i>raised plate</i> 26 cm   2 cm pack: 6		*34.43409 HVBLPD271 πίατο βαθύ coupe <i>deep coupe plate</i> 28,1 cm pack: 12		*34.43416 HVNADB201 μπολ βαθύ, 51 cl <i>deep bowl</i> 19,9x16,8 cm pack: 6
	*34.43403 HVBLEVP61 πίατο ρηχό coupe <i>coupe plate</i> 16,5 cm pack: 12		*34.43405 HVBLEVB71 μπολ coupe <i>coupe bowl</i> 18,2 cm pack: 12		*34.43406 HVBLXO111 πιατέλα παραλ/μη <i>chefs' oblong plate</i> 29,8x15,3 cm pack: 12
	*34.43402 HVBLEVP81 πίατο ρηχό coupe <i>coupe plate</i> 21,7 cm pack: 12		*34.43404 HVBLEVB91 μπολ coupe <i>coupe bowl</i> 24,8 cm pack: 12		*34.43407 HVBLXO141 πιατέλα παραλ/μη <i>chefs' oblong plate</i> 35,5x18,9 cm pack: 6
	*34.43401 HVBLEV101 πίατο ρηχό coupe <i>coupe plate</i> 26 cm pack: 12		*34.43410 HVBLOGB11 πίατο βαθύ <i>organic bowl</i> 25,3 cm pack: 12		*34.43411 HVBLDR281 πιατέλα ορθογώνια <i>rectangular tray</i> 28,7x19 cm pack: 6
	*34.43400 HVBLEV111 πίατο ρηχό coupe <i>coupe plate</i> 28,8 cm pack: 12				*34.43412 HVBLDR341 πιατέλα ορθογώνια <i>rectangular tray</i> 34,5x23,3 cm pack: 6



ΝΕΟ  
Προϊόν

# Harvest plum



\*34.44279 HVPLEVP61  
πίατο ρηχό coupe  
*coupe plate*  
16,5 cm  
pack: 12



\*34.44280 HVPLEVP81  
πίατο ρηχό coupe  
*coupe plate*  
21,7 cm  
pack: 12



\*34.44275 HVPLEVI01  
πίατο ρηχό coupe  
*coupe plate*  
26 cm  
pack: 12



\*34.44276 HVPLEVI11  
πίατο ρηχό coupe  
*coupe plate*  
28,8 cm  
pack: 12



\*34.44277 HVPLEVB71  
μπολ coupe  
*coupe bowl*  
18,8 cm  
pack: 12



\*34.44278 HVPLEVB91  
μπολ coupe  
*coupe bowl*  
24,8 cm  
pack: 12



\*34.44273 HVPLDOB11  
πατέλα παραλ/μη  
*chefs' oblong plate*  
27x16 cm  
pack: 12



\*34.44274 HVPLDOB21  
πατέλα παραλ/μη  
*chefs' oblong plate*  
34,6x15,6 cm  
pack: 6



# Finca sandstone



\*34.44093 MCFSDU231  
 πιάτο ρηχό coupe  
*coupe plate*  
 23 cm  
 pack: 12



\*34.44092 MCFSDU271  
 πιάτο ρηχό coupe  
*coupe plate*  
 27,5 cm  
 pack: 12



\*34.44091 MCFSDU291  
 πιάτο ρηχό coupe  
*coupe plate*  
 29 cm  
 pack: 12



\*34.44094 MCFSDU311  
 πιάτο ρηχό  
*flat plate*  
 31,8 cm  
 pack: 12



\*34.44095 MCFSWP261  
 πιάτο raised  
*raised plate*  
 26 cm  
 pack: 12



\*34.44097 MCFSDC251  
 μπολ coupe  
*coupe bowl*  
 25 cm  
 pack: 12



\*34.44096 MCFSDC291  
 μπολ coupe  
*coupe bowl*  
 27,9 cm  
 pack: 12



\*34.44099 MCFSDOB11  
 πιατέλα ορθογώνια  
*rectangular plate*  
 27x16 cm  
 pack: 12









\*34.44098 MCFSDOB21  
 πιατέλα ορθογώνια  
*rectangular plate*  
 34,6x15,6 cm  
 pack: 12





νέο  
προϊόν

Jute

	*34.44260 MCJGDU231 πίατο ρηχό coupe <i>coupe plate</i> 23 cm pack: 12
	*34.44261 MCJGDU271 πίατο ρηχό coupe <i>coupe plate</i> 27,5 cm pack: 12
	*34.44262 MCJGDU291 πίατο ρηχό coupe <i>coupe plate</i> 29 cm pack: 12
	*34.44256 MCJGDC251 μπολ coupe <i>coupe bowl</i> 25 cm pack: 12
	*34.44257 MCJGDC291 μπολ coupe <i>coupe bowl</i> 27,9 cm pack: 12
	*34.44258 HVPLDOB11 πατέλα παραλ/μη <i>chefs' oblong plate</i> 27x16 cm pack: 12
	*34.44259 MCJGDOB21 πατέλα παραλ/μη <i>chefs' oblong plate</i> 34,6x15,6 cm pack: 6

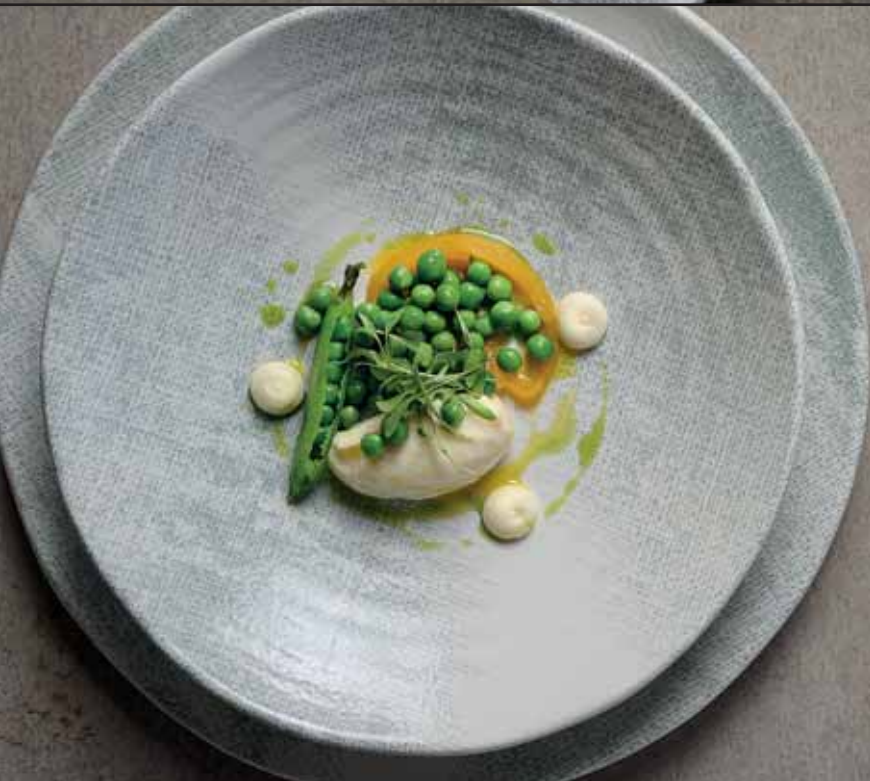

# Evo origins











Έχει σχεδιαστεί για να συμπληρώσει την συλλογή Evo και χρησιμοποιεί την γνωστή ποιότητα finest vitrified.

Χαρακτηρίζεται από το διακριτικό ντεκόρ της και κάθε κομμάτι έχει μια πρωτοποριακή και βάρδιση.









Η συλλογή της Dudson διατίθεται Πανελλαδικά με εξαίρεση τις περιοχές Κέρκυρας, Ηπείρου και Μακεδονίας.

*It has been designed to complement the original Dudson Evo range. Made in England in the Dudson finest vitrified ceramic body, features a subtle textured decoration. Each piece is finished in an innovative matte glaze.*

## Evo origins natural grey

	*34.43453 EOGYEV61 πίατο ρηχό coupe coupe plate 16,5 cm pack: 12		*34.43459 EOGYPD271 πίατο βαθύ coupe deep coupe plate 28,1 cm pack: 12
	*34.43452 EOGYEV81 πίατο ρηχό coupe coupe plate 21,7 cm pack: 12		*34.43455 EOGYEV71 μπολ coupe coupe bowl 18,2 cm pack: 12
	*34.43451 EOGYEV101 πίατο ρηχό coupe coupe plate 26 cm pack: 12		*34.43454 EOGYEV91 μπολ coupe coupe bowl 24,8 cm pack: 12
	*34.43450 EOGYEV111 πίατο ρηχό coupe coupe plate 28,8 cm pack: 12		*34.43456 EOGYXO111 πιπέλα παραλμν chefs' oblong plate 29,8x15,3 cm pack: 12
	*34.43458 EOGYPD251 πίατο βαθύ coupe deep coupe plate 25,5 cm pack: 12		*34.43457 EOGYXO141 πιπέλα παραλμν chefs' oblong plate 35,5x18,9 cm pack: 6

## Evo origins midnight black

	*34.43473 EOBKEVP61 πίατο ρηχό coupe coupe plate 16,5 cm pack: 12		*34.43478 EOBKPD271 πίατο βαθύ coupe deep coupe plate 28,1 cm pack: 12
	*34.43472 EOBKEVP81 πίατο ρηχό coupe coupe plate 21,7 cm pack: 12		*34.43475 EOBKEVB71 μπολ coupe coupe bowl 18,2 cm pack: 12
	*34.43471 EOBKEV101 πίατο ρηχό coupe coupe plate 26 cm pack: 12		*34.43474 EOBKEVB91 μπολ coupe coupe bowl 24,8 cm pack: 12
	*34.43470 EOBKEV111 πίατο ρηχό coupe coupe plate 28,8 cm pack: 12		*34.43476 EOBKXO111 πιπέλα παραλμν chefs' oblong plate 29,8x15,3 cm pack: 12
	*34.43477 EOBKPD251 πίατο βαθύ coupe deep coupe plate 25,5 cm pack: 12		



handcrafted



5 YEAR  
EDGE CHIP  
WARRANTY



durability



fully glazes foot



stackable



microwave safe



dishwasher safe

# Evo

Το Evo έχει σχεδιαστεί με κεραμική εμφάνιση. Η οικεία αυτή γοητεία, προσθέτει άγγιγμα ζεστασιάς σε κάθε επιφάνεια. Μια αναπαραγωγή του σχήματος και της κεραμικής αισθητικής. Το Evo διαθέτει δεκαπέντε κομμάτια στα τρία καλά εδραιωμένα χρώματα νάδωονς.



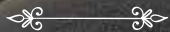



Η συνδρογή της Dudson διατίθεται Πανελλαδικά με εξαίρεση τις περιοχές Κέρκυρας, Ηπείρου και Μακεδονίας.



Evo has been designed with the appearance of hand-thrown pottery and its homely charm adds a touch of warmth to any tabletop. A replication of shape and aesthetics, Evo is available across fifteen items in three well established glaze colours, Granite, Jet and Pearl.

The fully glazed pieces are hand dipped on Vitrified Stoneware and the reactive colours create variation, making each piece individual. Although the collection may look handcrafted, Evo is supremely practical and whatever your particular service requirements, items can be mixed and matched to suit.

## Evo granite

	*34.44066 EVOGPC161 πίατο coupe   coupe plate 16,2 cm pack: 6		*34.44062 EVOGDP241 πίατο βαθύ deep plate 24,3 cm pack: 6
	*34.44067 EVOGPC201 πίατο coupe   coupe plate 20,5 cm pack: 6		*34.44063 EVOGDP291 πίατο βαθύ deep plate 29,3 cm pack: 4
	*34.44068 EVOGPC221 πίατο coupe   coupe plate 22,9 cm pack: 6		*34.44060 EVOGDO211 μπολ βαθύ οβάλ deep oval bowl 21,6 cm   100 cl pack: 6
	*34.44069 EVOGPC271 πίατο coupe   coupe plate 27,3 cm pack: 6		*34.44061 EVOGDO261 μπολ βαθύ οβάλ deep oval bowl 26,7 cm   110 cl pack: 6
	*34.44070 EVOGPC291 πίατο coupe   coupe plate 29,5 cm pack: 6		*34.44071 EVOGRB101 μπολ ρυζιού   rice bowl 10,5 cm   20 cl pack: 6
	*34.44064 EVOGFP251 πίατο raised raised plate 25,2 cm pack: 6		*34.44072 EVOGRB171 μπολ ρυζιού   rice bowl 17,8 cm   85 cl pack: 6
	*34.44065 EVOGFP311 πίατο raised raised plate 31,8 cm pack: 4		*34.44073 EVOGRT271 δίσκος ορθογώνιος rectangular trays 27,2x12,5 cm pack: 6
			*34.44074 EVOGRT361 δίσκος ορθογώνιος rectangular trays 35,6x17,1 cm pack: 4



handcrafted



2 YEAR  
EDGE CHIP  
WARRANTY



durability



stackable



microwave safe

















dishwasher safe





# Evo pearl

	<b>*34.44008</b> EVOPPC161 πίατο coupe   <i>coupe plate</i> 16,2 cm pack: 6		<b>*34.44004</b> EVOPDP241 πίατο βαθύ coupe <i>deep coupe plate</i> 24,3 cm pack: 6
	<b>*34.44009</b> EVOPPC201 πίατο coupe   <i>coupe plate</i> 20,5 cm pack: 6		<b>*34.44005</b> EVOPDP291 πίατο βαθύ coupe <i>deep coupe plate</i> 29,3 cm pack: 4
	<b>*34.44000</b> EVOPPC221 πίατο coupe   <i>coupe plate</i> 22,9 cm pack: 6		<b>*34.44002</b> EVOPDO211 μπολ βαθύ οβάλ <i>deep oval bowl</i> 21,6 cm   100 cl pack: 6
	<b>*34.44010</b> EVOPPC271 πίατο coupe   <i>coupe plate</i> 27,3 cm pack: 6		<b>*34.44003</b> EVOPDO261 μπολ βαθύ οβάλ <i>deep oval bowl</i> 26,7 cm   110 cl pack: 6
	<b>*34.44011</b> EVOPPC291 πίατο coupe   <i>coupe plate</i> 29,5 cm pack: 6		<b>*34.44001</b> EVOPRB101 μπολ ρυζιού   <i>rice bowl</i> 10,5 cm   20 cl pack: 6
	<b>*34.44006</b> EVOPFP251 πίατο raised <i>raised plate</i> 25,2 cm pack: 6		<b>*34.44012</b> EVOPRB171 μπολ ρυζιού   <i>rice bowl</i> 17,8 cm   85 cl pack: 6
	<b>*34.44007</b> EVOPFP311 πίατο raised <i>raised plate</i> 31,8 cm pack: 4		<b>*34.44013</b> EVOPRT271 δίσκος ορθογώνιος <i>rectangular trays</i> 27,2x12,5 cm pack: 6
			<b>*34.44014</b> EVOPRT361 δίσκος ορθογώνιος <i>rectangular trays</i> 35,6x17,1 cm pack: 4



handcrafted



2 YEAR  
EDGE CHIP  
WARRANTY



durability



stackable



microwave safe



dishwasher safe



	*34.44036 EVOJPC161 πίατο coupe   <i>coupe plate</i> 16,2 cm pack: 6		*34.44032 EVOJDP241 πίατο βαθύ coupe <i>deep coupe plate</i> 24,3 cm pack: 6
	*34.44037 EVOJPC201 πίατο coupe   <i>coupe plate</i> 20,5 cm pack: 6		*34.44033 EVOJDP291 πίατο βαθύ coupe <i>deep coupe plate</i> 29,3 cm pack: 4
	*34.44038 EVOJPC221 πίατο coupe   <i>coupe plate</i> 22,9 cm pack: 6		*34.44030 EVOJDO211 μπολ βαθύ οβάλ <i>deep oval bowl</i> 21,6 cm   100 cl pack: 6
	*34.44039 EVOJPC271 πίατο coupe   <i>coupe plate</i> 27,3 cm pack: 6		*34.44031 EVOJDO261 μπολ βαθύ οβάλ <i>deep oval bowl</i> 26,7 cm   110 cl pack: 6
	*34.44040 EVOJDP291 πίατο coupe   <i>coupe plate</i> 29,5 cm pack: 6		*34.44041 EVOJRB101 μπολ ρυζιού <i>rice bowl</i> 10,5 cm   20 cl pack: 6
	*34.44034 EVOJFP251 πίατο raised <i>raised plate</i> 25,2 cm pack: 6		*34.44042 EVOJRB171 μπολ ρυζιού <i>rice bowl</i> 17,8 cm   85 cl pack: 6
	*34.44035 EVOJFP311 πίατο raised <i>raised plate</i> 31,8 cm pack: 4		*34.44043 EVOJRT271 δίσκος ορθογώνιος <i>rectangular trays</i> 27,2x12,5 cm pack: 6
			*34.44044 EVOJRT361 δίσκος ορθογώνιος <i>rectangular trays</i> 35,6x17,1 cm pack: 4





# VISTA ALEGRE





















1824

Οι σειρές «Vista Alegre Hotelware» της Vista Alegre προσφέρουν ένα ξεχωριστό σύνολο προϊόντων που έχουν σχεδιάσει από κοινού διάσημοι σχεδιαστές και παγκοσμίως φήμης σεφ. Ανθεκτικά, λειτουργικά και καινοτόμα που θα ικανοποιήσουν στο μέγιστο τους απαιτητικούς επαγγελματίες.

The «Vista Alegre Hotelware» ranges offers a distinctive set of products jointly developed with prestigious designers and renowned chefs worldwide. Resistent, functional, and innovative pieces bound to satisfy the most demanding professionals.



## Domo

	*38.99996 πίατο ρηχό   <i>plate</i> 17 cm pack: 4		*38.00009 μπολ κονσομέ <i>soup cup</i> , 30 cl pack: 4		*38.00030 τσαγιέρα   <i>tea pot</i> 131 cl pack: 1
	*38.99995 πίατο ρηχό   <i>plate</i> 23,2 cm pack: 4		*38.00012 πιατάκι   <i>saucer</i> , 19 cm pack: 12		*38.00031 καφετιέρα   <i>coffee pot</i> 99 cl 8,7x24,6 cm pack: 1
	*38.99993 πίατο ρηχό   <i>plate</i> 28 cm pack: 4		*38.02520 μπολ   <i>bowl</i> , 22 cm pack: 4		*38.00032 γαλατιέρα   <i>creamer</i> 34 cl pack: 1
	*38.99992 πίατο ρηχό   <i>plate</i> 33 cm pack: 4		*38.00001 μπολ   <i>bowl</i> , 30 cm pack: 1		*38.00033 ζαχαριέρα   <i>sugar pot</i> 35,5 cl pack: 1
	*38.99994 πίατο βαθύ   <i>deep plate</i> 25,2 cm pack: 4		*38.00000 πιατέλα οβάλ <i>oval platter</i> 35x26,5 cm pack: 1		*38.00029 φλιτζάνι καφέ <i>coffee cup</i> , 10 cl pack: 12
	*38.00485 πίατο pasta   <i>pasta plate</i> 28 cm pack: 4		*38.99998 πιατέλα οβάλ <i>oval platter</i> 41,5x32 cm pack: 1		*38.00028 πιατάκι   <i>saucer</i> , 13 cm pack: 12
	*38.02517 μπολ   <i>bowl</i> , 12 cm pack: 4		*38.99997 σαλτσιέρα με πιατάκι <i>sauceboat and saucer</i> 50 cl pack: 1		*38.00024 φλιτζάνι τσαγιού <i>tea cup</i> , 25 cl pack: 12
			*38.03227 αλατιέρα   <i>salt shaker</i> pack: 2		*38.00022 πιατάκι   <i>saucer</i> , 16,8 cm pack: 12
			*38.03228 πιπεριέρα   <i>pepper shaker</i> pack: 2		



38.01973  
πιατέλα οβάλ  
*oval platter*  
33x25 cm  
pack: 1



38.01972  
πιατέλα οβάλ  
*oval platter*  
37x28 cm  
pack: 1



\*38.08457  
σαλοτιέρα | *sauceboat*  
20 cl  
pack: 1



\*38.08437  
τοαγιέρα | *tea pot*  
40 cl  
pack: 1



\*38.08439  
καφετιέρα | *coffee pot*  
40 cl  
pack: 1



\*38.08001  
γαλατιέρα | *creamer*  
30 cl  
pack: 1



38.01974  
φλιτζάνι καφέ στοιβ.  
*coffee cup stacking*,  
10 cl  
pack: 12



38.01967  
πιατάκι | *saucer*, 12 cm  
pack: 12



38.01978  
φλιτζάνι τοαγιού στοιβ.  
*tea cup stacking*, 20 cl  
pack: 12







38.01968  
πιατάκι | *saucer*, 16 cm  
pack: 12



38.01980  
φλιτζ breakfast στοιβ.,  
*breakfast cup stacking*,  
27 cl  
pack: 12

38.01968  
πιατάκι | *saucer*, 15 cm  
pack: 12













\*38.08459  
κούπα | *mug*,  
40 cl  
pack: 6

	38.01966 πιάτο ρηχό   <i>plate</i> 17 cm pack: 12
	38.01965 πιάτο ρηχό   <i>plate</i> 21 cm pack: 12
	38.01963 πιάτο ρηχό   <i>plate</i> 25 cm pack: 12
	38.01962 πιάτο ρηχό   <i>plate</i> 27 cm pack: 12
	38.01961 πιάτο ρηχό   <i>plate</i> 30 cm pack: 4



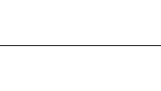









	38.01960 πιάτο ρηχό   <i>plate</i> 32 cm pack: 4
	38.01964 πιάτο βαθύ   <i>deep plate</i> 23,5 cm pack: 12
	38.01984 πιάτο pasta   <i>pasta plate</i> 24,5 cm pack: 1
	38.01982 μπολ κονσομέ <i>soup cup</i> , 26,5 cl pack: 6
	38.01969 πιατάκι   <i>saucer</i> , 16,2 cm pack: 12
	38.01971 μπολ   <i>bowl</i> 44 cl   12 cm pack: 6
	38.01970 μπολ   <i>bowl</i> 215 cl   23 cm pack: 2



# Gourmet

	38.96343 πίατο ρηχό   <i>plate</i> 16,5 cm pack: 6
	38.96344 πίατο ρηχό   <i>plate</i> 22,5 cm pack: 6
	38.96345 πίατο ρηχό   <i>plate</i> 28,5 cm pack: 6
	38.96347 πίατο ρηχό   <i>plate</i> 31,5 cm pack: 2
	38.96348 πίατο παρουσιάσιον <i>presentation plate</i> 30 cm pack: 2
	38.96349 πίατο βαθύ   <i>deep plate</i> 28 cm pack: 6
	38.96346 πίατο βαθύ   <i>deep plate</i> 31,5 cm pack: 2
	38.04440 μπολ κονοσμέ <i>soup cup</i> , 30,7 cl pack: 6
	38.96402 πιατάκι   <i>saucer</i> 20x15 cm pack: 6
	38.96352 μπολ   <i>bowl</i> 39 cl   14 cm pack: 6
	*38.96350 μπολ   <i>bowl</i> 60 cl   16 cm pack: 1
	*38.96351 μπολ   <i>bowl</i> 150 cl   25x20 cm pack: 1



	38.96359 πιατέλα οβάλ <i>oval platter</i> 28,5x21 cm pack: 1		*38.96335 ζαχαριέρα   <i>sugar bowl</i> 10 cm pack: 1
	38.96358 πιατέλα οβάλ <i>oval platter</i> 35x26 cm pack: 1		38.96334 ζαχαρ. για φακελάκια <i>sugar box</i> , 9x6,5 cm pack: 1
	*38.96360 πίατο βουτύρου <i>butter dish</i> , 11 cm pack: 6		38.96338 φλιτζάνι καφέ <i>coffee cup</i> , 9 cl pack: 12
	*38.96357 πιατάκι για ελιές <i>olive dish</i> , 20x10 cm pack: 6		38.96341 πιατάκι   <i>saucer</i> 12,5x10 cm pack: 12
	38.96336 τσαγιέρα   <i>tea pot</i> 41 cl pack: 1		38.96339 φλιτζάνι τσαγιού <i>tea cup</i> , 18 cl pack: 12
	38.96340 γαλατιέρα   <i>creamer</i> 23 cl pack: 1		38.96342 πιατάκι   <i>saucer</i> 16x13 cm pack: 12





# Utopia



	*38.27757 πίατο ρηχό   <i>plate</i> 17 cm pack: 4
	*38.27756 πίατο ρηχό   <i>plate</i> 23 cm pack: 4
	*38.27754 πίατο ρηχό   <i>plate</i> 29 cm pack: 4
	*38.27753 πίατο ρηχό   <i>plate</i> 32 cm pack: 4
	*38.27758 πίατο pasta   <i>pasta plate</i> 28 cm pack: 4
	*38.27755 πίατο βαθύ   <i>deep plate</i> 27 cm pack: 6
	*38.27762 μπολ   <i>bowl</i> 11 cm pack: 4
	*38.27761 μπολ   <i>bowl</i> 16 cm pack: 6
	*38.27760 μπολ   <i>bowl</i> 22 cm pack: 1
	*38.27759 πατέλα   <i>platter</i> 35x28 cm pack: 1
	*38.27767 γαλατιέρα   <i>creamer</i> 26 cl pack: 1
	*38.27766 ζαχαριέρα   <i>sugar bowl</i> 36 cl pack: 1

	*38.27764 φλιτζάνι με πιατάκι <i>coffee cup &amp; saucer</i> 10 cl pack: 4
	*38.27765 φλιτζάνι με πιατάκι <i>coffee cup &amp; saucer</i> 24 cl pack: 2
	*38.27763 κούπα   <i>mug</i> 42 cl pack: 4

	*38.31018 φλιτζ. στοιβ. με πιατάκι <i>cup &amp; saucer stacking</i> 9 cl pack: 4
	*38.31019 φλιτζ. στοιβ. με πιατάκι <i>cup &amp; saucer stacking</i> 22 cl pack: 2
	*38.31020 φλιτζ. στοιβ. με πιατάκι <i>cup &amp; saucer stacking</i> 31,1 cl pack: 6

# Chefs' collection

\*38.16371

«Rotondo plate»  
30,4 cm  
pack: 1



\*38.21057

πίατο τρίγωνο  
*triangle plate*  
«Deltha plate»  
29 cm | 3,9 cm  
pack: 1



38.31087  
πίατο | *plate*  
«Totem»,  
28,1 cm | 5,4cm  
pack: 2



38.31101  
«Reef biscuit»  
19,4x16,5 cm | 7,7 cm  
pack: 2



38.23921  
πίατο | *plate*  
«Rizotto», 27 cm  
(set of 6)  
pack: 1



\*38.22196  
«Seventy Lake»  
26 cm  
pack: 6



38.11653  
πίατο δύο επιπέδων  
*two-level plate* «Step plate»  
32,7x23,4 cm  
pack: 1



\*38.17388  
«Espiral gourmand»  
31,7 cm  
pack: 2



\*38.22058  
«Naiz»,  
30 cm  
pack: 6



## Chefs' collection

\*38.23798  
«Coral» glaze, 31 cm  
pack: 6



\*38.33609  
«Bottle leaf»  
27,7x7,8 cm  
pack: 6



\*38.35480  
«Bordado», 31 cm  
pack: 4



\*38.11133  
πίατο οβάλ | oval plate  
«Atlantis plate»  
31,7x25 cm  
pack: 1



\*38.31090  
πίατο | plate  
«Fluctus glaze»  
30,8 cm | 1,6 cm  
pack: 6



\*38.31088  
πίατο | plate  
«Fluctus biscuit»  
30,8 cm | 1,6 cm  
pack: 6

\*38.33430  
«Santola»  
19,4x18,3 cm | 6,4 cm  
pack: 2



\*38.21593  
«Egg plate»  
14 cm | 15 cm  
pack: 5







## Infinita



\*38.21478 21121478  
πίατο μεγάλο  
*large plate*  
28,6 cm | 3,7 cm  
pack: 2



\*38.21479 21121479  
πίατο μικρό  
*small plate*  
22 cm | 7,1 cm  
pack: 2



\*38.31086  
πίατο οβάλ  
*oval plate*  
30,5x20,5 cm | 5,5 cm  
pack: 2



\*38.31085  
πίατο tasting  
*tasting plate*  
14 cm | 6,7 cm  
pack: 2



\*38.00468  
πίατο γυάλινο  
*small plate glass*  
22 cm | 7,1 cm  
pack: 2

## Vernissage



\*38.31013  
πίατο | *plate*  
14 cm | 4,5 cm  
pack: 4



\*38.31014  
πίατο | *plate*  
21 cm | 4,5 cm  
pack: 2



\*38.31015  
πίατο | *plate*  
29 cm | 5 cm  
pack: 2



## Mineral



\*38.23216 21123216  
 πιάτο με στρογγυλό  
 εσωτερικό, υαλομένο  
*round plate glaze*  
 23,7 cm | 3,1 cm  
 pack: 4



\*38.23217 21123217  
 πιάτο με ορθογώνιο  
 εσωτερικό, υαλομένο  
*rectangular plate glaze*  
 23,7 cm | 3,1 cm  
 pack: 4



## Texture



\*38.30974  
 πιάτο παρουσίασης  
*presentation plate*  
 «Scales»  
 33,1 cm  
 pack: 4



\*38.30973 21130973  
 πιάτο παρουσίασης  
*presentation plate*  
 «Rain»  
 33,1 cm  
 pack: 4



\*38.30971 21130971  
 πιάτο παρουσίασης  
*presentation plate*  
 «Drizzle»  
 33,1 cm  
 pack: 4



\*38.30972 21130972  
 πιάτο παρουσίασης  
*presentation plate*  
 «Crocodile»  
 33,1 cm  
 pack: 4



## Temptation



\*38.22367  
 πιάτο ασύμμετρο  
 με μικρό εσωτερικό  
*plate small center*  
 29 cm | 4,8 cm  
 pack: 4



\*38.22366  
 πιάτο ασύμμετρο  
 με μεγάλο εσωτερικό  
*plate large center*  
 29 cm | 4,8 cm  
 pack: 4



## Trace

	<p>*38.25798                  πιάτο ρηχό   <i>plate</i>                  30 cm                  pack: 4</p>
	<p>*38.26246                  πιάτο ρηχό   <i>plate</i>                  30 cm                  pack: 4</p>
	<p>*38.25800                  φαρδύ μπολ   <i>large bowl</i>                  20 cm   36 cl                  pack: 4</p>
	<p>*38.25799                  μπολ ψηλό   <i>bowl high</i>                  13,4 cm   28,4 cl                  pack: 4</p>



## Theatre

	<p>*38.21477                  πιάτο ρηχό   <i>plate</i>                  25 cm   2,6 cm                  pack: 4</p>
	<p>*38.21475                  πιάτο ρηχό   <i>plate</i>                  30 cm   2,7 cm                  pack: 4</p>
	<p>*38.24349                  πιάτο ρηχό   <i>plate</i>                  30 cm   2,7 cm                  pack: 4</p>
	<p>*38.21656                  πιάτο ρηχό   <i>plate</i>                  27 cm   4,8 cm                  pack: 4</p>
	<p>*38.21476                  πιάτο βαθύ   <i>deep plate</i>                  27 cm   4,3 cm                  pack: 4</p>





## O! Moon



\*38.18676  
πίατο ρηχό | *plate*  
27 cm  
pack: 4



\*38.18677  
πίατο βαθύ | *deep plate*  
27 cm  
pack: 4



\*38.18678  
πίατο βαθύ | *deep plate*  
20 cm  
pack: 4



\*38.18679  
πίατο ρηχό | *plate*  
28 cm  
pack: 4



\*38.18680  
πίατο ρηχό | *plate*  
28 cm  
pack: 4



\*38.21480  
δοχείο αφρού  
μοριακής κουζίνας  
*foam container*  
8 cm | 11,4 cl  
pack: 12



\*38.31092  
δοχείο με καπάκι  
και φίλτρο  
*box manzana Aroma  
with filter*  
14,1 cm | 11,9 cl  
pack: 1



\*38.31093  
δοχείο με καπάκι  
και φίλτρο  
*box manzana Gusto  
with filter*  
14,1 cm | 11,9 cl  
pack: 1

## Natura

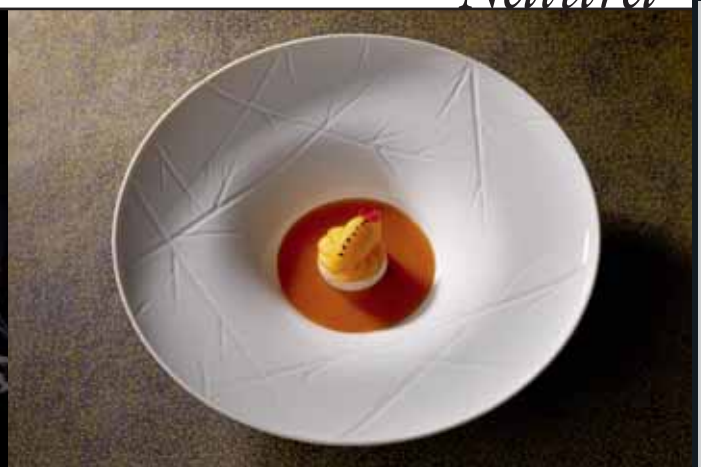

\*38.31071  
πίατο | *plate*  
«Natura glaze»  
25 cm  
pack: 4



\*38.17284  
πίατο | *plate*  
«Natura glaze»  
33 cm  
pack: 4



\*38.31073  
πίατο βαθύ | *deep plate*  
«Natura glaze»  
28,5 cm | 6,1 cm  
pack: 4

The company was founded in 1989 and today exporting its products to 52 countries worldwide.

Gural is considered a pioneer in its area, mainly due to the production technology it uses, the choice of high quality of the raw materials, while all production processes are friendly to the environment.

The quality of its products is certified with TSE and ISO 9001.

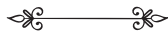

Η εταιρεία ιδρύθηκε το 1989 και σήμερα εξάγει τα προϊόντα της σε 52 χώρες σε όλο τον κόσμο. Θεωρείται πρωτοπόρος στο χώρο της, λόγω κυρίως της τεχνολογίας που χρησιμοποιεί στην παραγωγή των προϊόντων της αλλά και των μεγάλων δυνατοτήτων παραγωγής της.

Μεγάλη έμφαση δίδεται από το τμήμα έρευνας και ανάπτυξης της εταιρείας (R&D department), στην ανάπτυξη καινοτόμων διαδικασιών παραγωγής και τη συνεχή βελτίωση της ποιότητας των προϊόντων της.

Η επιλογή των πρώτων υλών γίνεται πολύ προσεκτικά, ενώ όλες οι διαδικασίες παραγωγής είναι φιλικές προς το περιβάλλον.





Η ποιότητα των προϊόντων της πιστοποιείται με TSE και ISO 9001.

## Athens





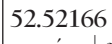









	52.10100 πίατο coupe   coupe plate 17 cm pack: 12
	52.10101 πίατο coupe   coupe plate 20 cm pack: 12
	52.10102 πίατο coupe   coupe plate 25 cm pack: 12
	52.10107 πίατο ρηχό gourmet gourmet plate «Pure» 28 cm pack: 6
	52.10108 πίατο ρηχό gourmet gourmet plate «Pure» 32 cm pack: 6
	52.10106 πίατο ρηχό gourmet με rim   gourmet plate with rim, 31 cm pack: 6
	52.10103 πίατο βαθύ coupe deep coupe plate 23 cm pack: 12
	52.10104 μπολ gourmet coupe gourmet coupe bowl 26 cm pack: 6
	52.10105 πίατο βαθύ gourmet με rim, gourmet deep plate with rim 27 cm pack: 6
	52.10109 πιατέλα οβάλ oval platter 30x18 cm pack: 6



# Flora



















	52.52151 πίατο ρηχό   <i>plate</i> 16 cm pack: 12
	52.52155 πίατο ρηχό   <i>plate</i> 20 cm pack: 12
	52.52160 πίατο ρηχό   <i>plate</i> 25 cm pack: 12
	52.52163 πίατο ρηχό   <i>plate</i> 27 cm pack: 12
	52.52165 πίατο ρηχό   <i>plate</i> 30 cm pack: 6
	52.52170 πίατο βαθύ   <i>deep plate</i> 24 cm pack: 12
	52.44211 μπολ κονοσομέ <i>soup bowl</i> , 35 cl pack: 12
	52.52166 πατάκι   <i>saucer</i> , 17 cm pack: 12
	52.44201 μπολ   <i>bowl</i> , 14 cm pack: 12
	52.44205 μπολ   <i>bowl</i> , 23 cm pack: 6
	52.44210 joker   <i>joker</i> , 10 cm pack: 12
	52.56178 πατέλα οβάλ <i>oval platter</i> , 18x11 cm pack: 12
	52.56180 πατέλα οβάλ <i>oval platter</i> , 23x15 cm pack: 6
	52.56183 πατέλα οβάλ <i>oval platter</i> , 28x18 cm pack: 6























	52.56187 πατέλα οβάλ <i>oval platter</i> , 32x23 cm pack: 6		52.37209 καφετιέρα   <i>coffee pot</i> 35 cl pack: 6
	52.56184 πατέλα οβάλ <i>oval platter</i> , 36x25 cm pack: 6		*52.37210 καφετιέρα   <i>coffee pot</i> 75 cl pack: 6
	52.56186 πατέλα ορθογώνια <i>rectangular platter</i> 34x24 cm pack: 6		*52.37215 καφετιέρα   <i>coffee pot</i> 150 cl pack: 2
	52.64115 σουπιέρα   <i>soup tureen</i> 3,2 lt pack: 1		52.27050 γαλατιέρα   <i>creamer</i> 10 cl pack: 6
	52.84095 αλατιέρα   <i>salt shaker</i> 5 cm pack: 24		52.33070 ζαχαριέρα   <i>sugar pot</i> 25 cl pack: 6
	52.84096 πιπεριέρα   <i>pepper shaker</i> 5 cm pack: 24		52.84250 φλιτζάνι καφέ με πιάτο <i>coffee cup with saucer</i> 12 cl - 13 cm pack: 12
	52.22100 ανθοδοχείο   <i>flower vase</i> 14 cm pack: 12		52.84260 φλιτζ τσαγιού με πιάτο <i>tea cup with saucer</i> 22 cl - 16 cm pack: 12
	52.71050 τσαγιέρα   <i>tea pot</i> 27,5 cl pack: 6		



## X-Tanbul

	<b>52.01670</b> πιάτο ρηχό   <i>plate</i> 17 cm pack: 12		<b>52.01676</b> πιάτο ρηχό   <i>plate</i> 30 cm pack: 6		<b>52.01690</b> μπολ   <i>bowl</i> , 15 cm pack: 12
	<b>52.01671</b> πιάτο ρηχό   <i>plate</i> 19 cm pack: 12		<b>52.01677</b> πιάτο ρηχό   <i>plate</i> 32 cm pack: 6		<b>52.01691</b> μπολ   <i>bowl</i> , 19 cm pack: 12
	<b>52.01672</b> πιάτο ρηχό   <i>plate</i> 21 cm pack: 12		<b>52.01679</b> πιάτο βαθύ   <i>deep plate</i> 22 cm pack: 12		<b>52.01692</b> μπολ   <i>bowl</i> , 25 cm pack: 6
	<b>52.01673</b> πιάτο ρηχό   <i>plate</i> 23 cm pack: 12		<b>52.01680</b> πιάτο pasta   <i>pasta plate</i> 30 cm pack: 6		<b>52.01713</b> μπολ joker   <i>joker</i> 6 cm   4 cl pack: 24
	<b>52.01674</b> πιάτο ρηχό   <i>plate</i> 25 cm pack: 12		<b>52.01717</b> μπολ κονσομέ <i>soup cup</i> , 38 cl pack: 12		<b>52.01714</b> μπολ joker   <i>joker</i> 8 cm   9 cl pack: 24
	<b>52.01675</b> πιάτο ρηχό   <i>plate</i> 27 cm pack: 12		<b>52.01718</b> πατάκι   <i>saucer</i> , 19 cm pack: 12		<b>52.01715</b> μπολ joker   <i>joker</i> 10 cm   18 cl pack: 24
					<b>52.01683</b> πιατέλα οβάλ <i>oval platter</i> , 20x16 cm pack: 6























	<b>52.01684</b> πιατέλα οβάλ <i>oval platter</i> , 24x19 cm pack: 6		<b>52.01699</b> θήκη οδοντογλιφίδων <i>tooth pick holder</i> , 4,5 cm pack: 24
	<b>52.01685</b> πιατέλα οβάλ <i>oval platter</i> , 29x23 cm pack: 6		<b>52.01694</b> ανθοδοχείο   <i>flower vase</i> 13 cm pack: 12
	<b>52.01686</b> πιατέλα οβάλ <i>oval platter</i> , 34x27 cm pack: 6		<b>52.01710</b> σταχτοδοχείο στοιβ. <i>ashtray stackable</i> , 9 cm pack: 24
	<b>52.01687</b> πιατέλα οβάλ <i>oval platter</i> , 39x31 cm pack: 6		<b>*52.01703</b> τσαγιέρα   <i>tea pot</i> 80 cl pack: 6
	<b>*52.01709</b> σουπιέρα   <i>soup tureen</i> 3,2 lt pack: 1		<b>52.01701</b> καφετιέρα   <i>coffee pot</i> 40 cl pack: 6
	<b>52.01704</b> σαλτσιέρα <i>gravy boat</i> , 40 cl pack: 6		<b>52.01702</b> καφετιέρα   <i>coffee pot</i> 60 cl pack: 6
	<b>52.01705</b> πιατάκι   <i>saucer</i> , 20 cm pack: 6		<b>52.01697</b> γαλατιέρα   <i>creamer</i> 15 cl pack: 6
	<b>52.01695</b> αλατιέρα   <i>salt shaker</i> 7 cm pack: 24		<b>52.01698</b> ζαχαριέρα   <i>sugar pot</i> 18 cl pack: 12
	<b>52.01696</b> πιπεριέρα   <i>pepper shaker</i> 7 cm pack: 24		<b>52.01711</b> φλιτζ στοιβ. με πιάτο <i>cup stackable with saucer</i> 9 cl - 12 cm pack: 12
	<b>52.01706</b> πετσετοθήκη <i>napkin holder</i> , 11x5 cm pack: 12		<b>52.01712</b> φλιτζ στοιβ. με πιάτο <i>cup stackable with saucer</i> 23 cl - 11,5 cm pack: 12





















Lizbon

	52.01777 πίατο ρηχό   <i>plate</i> 16 cm pack: 12		52.01756 πίατο ρηχό   <i>plate</i> 32 cm pack: 6		52.01759 πιατέλα οβάλ <i>oval platter</i> , 21x14 cm pack: 6
	52.01750 πίατο ρηχό   <i>plate</i> 18 cm pack: 12		52.01757 πίατο βαθύ   <i>deep plate</i> 23 cm pack: 12		52.01760 πιατέλα οβάλ <i>oval platter</i> , 24x17 cm pack: 6
	52.01751 πίατο ρηχό   <i>plate</i> 20 cm pack: 12		52.01758 πίατο pasta   <i>pasta plate</i> 30 cm pack: 6		52.01761 πιατέλα οβάλ <i>oval platter</i> , 29x20 cm pack: 6
	52.01752 πίατο ρηχό   <i>plate</i> 22 cm pack: 12		*52.01789 μπολ κονσομέ <i>soup cup</i> , 30 cl pack: 12		52.01762 πιατέλα οβάλ <i>oval platter</i> , 34x24 cm pack: 6
	52.01753 πίατο ρηχό   <i>plate</i> 24 cm pack: 12		*52.01790 πιατάκι   <i>saucer</i> , 18 cm pack: 12		52.01763 πιατέλα οβάλ <i>oval platter</i> , 39x27 cm pack: 6
	52.01754 πίατο ρηχό   <i>plate</i> 27 cm pack: 12		52.01769 μπολ   <i>bowl</i> , 15 cm pack: 12		52.01787 φλιτζάνι καφέ στοιβ. με πιατάκι <i>coffee cup stackable with saucer</i> 9 cl - 12,5 cm pack: 12
	52.01755 πίατο ρηχό   <i>plate</i> 30 cm pack: 6		52.01770 μπολ   <i>bowl</i> , 19 cm pack: 12		52.01788 φλιτζάνι τσαγιού στοιβ. με πιατάκι <i>tea cup stackable with saucer</i> 23 cl - 15 cm pack: 12
			52.01771 μπολ   <i>bowl</i> , 23 cm pack: 6		





# Saturn

	52.52498 πίατο ρηχό   <i>plate</i> 16 cm pack: 12
	52.52500 πίατο ρηχό   <i>plate</i> 18 cm pack: 12
	52.52502 πίατο ρηχό   <i>plate</i> 20 cm pack: 12
	52.52504 πίατο ρηχό   <i>plate</i> 22 cm pack: 12
	52.52506 πίατο ρηχό   <i>plate</i> 24 cm pack: 12
	52.52508 πίατο ρηχό   <i>plate</i> 26 cm pack: 12
	52.52510 πίατο ρηχό   <i>plate</i> 28 cm pack: 6
	52.52512 πίατο ρηχό   <i>plate</i> 30 cm pack: 6
	52.52514 πίατο ρηχό   <i>plate</i> 32 cm pack: 6
	52.52521 πίατο βαθύ   <i>deep plate</i> 23 cm pack: 12
	52.52524 πίατο pasta   <i>pasta plate</i> 30 cm pack: 6
	*52.44316 μπολ κονοομέ <i>soup cup</i> , 38 cl pack: 12
	*52.44317 πιατάκι   <i>saucer</i> , 18 cm pack: 12









	52.44300 μπολ   <i>bowl</i> , 15 cm pack: 12		*52.84060 αλατιέρα   <i>salt shaker</i> pack: 24
	52.44305 μπολ   <i>bowl</i> , 19 cm pack: 12		*52.84061 πιπεριέρα   <i>pepper shaker</i> pack: 24
	52.44310 μπολ   <i>bowl</i> , 25 cm pack: 6		*52.71120 τοαγιέρα   <i>tea pot</i> 45 cl pack: 6
	52.56300 πιατέλα οβάλ <i>oval platter</i> , 21x14 cm pack: 6		52.27110 γαλατιέρα   <i>creamer</i> 15 cl pack: 6
	52.56303 πιατέλα οβάλ <i>oval platter</i> , 24x17 cm pack: 6		52.84600 φλιτζάνι καφέ στοιβ. με πιατάκι <i>coffee cup stackable with saucer</i> 9 cl - 12 cm pack: 12
	52.56307 πιατέλα οβάλ <i>oval platter</i> , 29x20 cm pack: 6		52.84610 φλιτζάνι τοαγιού στοιβ. με πιατάκι <i>tea cup stackable with saucer</i> 23 cl - 15 cm pack: 12
	52.56308 πιατέλα οβάλ <i>oval platter</i> , 34x24 cm pack: 6		
	52.56309 πιατέλα οβάλ <i>oval platter</i> , 39x27 cm pack: 6		

# Bilbao

	<p>πίατο raised   <i>raised plate</i></p> <p>52.92000 21 cm pack: 12</p>
	<p>52.92001 25 cm pack: 12</p>
	<p>52.92002 27 cm pack: 6</p>
	<p>52.92003 29 cm pack: 6</p>
	<p>52.92004 πιατέλα   <i>platter</i> 19 cm pack: 6</p>













# Elips

	<p>52.01600 πίατο coupe   <i>coupe plate</i> 21x19 cm pack: 12</p>		<p>52.01605 πίατο βαθύ   <i>deep plate</i> 22x20 cm pack: 12</p>
	<p>52.01602 πίατο coupe   <i>coupe plate</i> 26x24 cm pack: 12</p>		<p>52.01607 μπολ   <i>bowl</i> 16x14 cm pack: 12</p>
	<p>52.01603 πίατο coupe   <i>coupe plate</i> 29x27 cm pack: 6</p>		<p>52.01608 μπολ   <i>bowl</i> 24x22 cm pack: 6</p>



# Mimoza























	<p>πίατο ρηχό   <i>plate</i></p> <p>52.52403 16x16 cm (18 cm) pack: 12</p>		<p>52.52420 πίατο βαθύ   <i>deep plate</i> 19x19 cm (22 cm) pack: 12</p>
	<p>52.52406 18x18 cm (21 cm) pack: 12</p>		<p>μπολ σαλάτας <i>salad bowl</i></p> <p>52.44100 14x14 cm (16 cm) pack: 12</p>
	<p>52.52409 22x22 cm (25 cm) pack: 6</p>		<p>52.44106 21x21 cm (25 cm) pack: 6</p>
	<p>52.52412 23x23 cm (27 cm) pack: 12</p>		<p>φλιτζάνι με πιατάκι <i>coffee cup with saucer</i></p> <p>52.84500 9 cl - 12x12 cm pack: 12</p>
	<p>52.52414 πίατο ρηχό   <i>plate</i> 25x25 cm (29 cm) pack: 12</p>		<p>52.84510 23 cl - 14x14 cm pack: 12</p>
	<p>52.52416 πίατο ρηχό   <i>plate</i> 28x28 cm (32 cm) pack: 12</p>		











Karizma

Π Ο Ρ Ο Ε Λ Α Ξ Ε Σ

	52.52001 πίατο ρηχό   <i>plate</i> 16 cm pack: 12		52.52015 πίατο ρηχό   <i>plate</i> 30 cm pack: 6		52.56027 πιατέλα οβάλ <i>oval platter</i> , 21x14 cm pack: 6
	52.52003 πίατο ρηχό   <i>plate</i> 18 cm pack: 12		52.52017 πίατο ρηχό   <i>plate</i> 32 cm pack: 6		52.56029 πιατέλα οβάλ <i>oval platter</i> , 24x17 cm pack: 6
	52.52005 πίατο ρηχό   <i>plate</i> 20 cm pack: 12		52.52019 πίατο βαθύ   <i>deep plate</i> 22 cm pack: 12		52.56031 πιατέλα οβάλ <i>oval platter</i> , 29x20 cm pack: 6
	52.52007 πίατο ρηχό   <i>plate</i> 22 cm pack: 12		*52.44050 μπολ κονσομέ <i>soup cup</i> , 38 cl pack: 12		52.56033 πιατέλα οβάλ <i>oval platter</i> , 34x23 cm pack: 6
	52.52009 πίατο ρηχό   <i>plate</i> 24 cm pack: 12		*52.44049 πιατάκι   <i>saucer</i> , 18 cm pack: 12		52.56035 πιατέλα οβάλ <i>oval platter</i> , 39x27 cm pack: 6
	52.52011 πίατο ρηχό   <i>plate</i> 26 cm pack: 12		52.44037 μπολ   <i>bowl</i> , 15 cm pack: 12		52.84100 φλιτζ.σοιβ. με πιάτο <i>coffee cup stackable</i> <i>with saucer</i> 9 cl - 12,5 cm pack: 12
	52.52013 πίατο ρηχό   <i>plate</i> 28 cm pack: 6		52.44039 μπολ   <i>bowl</i> , 19 cm pack: 12		52.84120 φλιτζ.σοιβ. με πιάτο <i>tea cup stackable</i> <i>with saucer</i> 23 cl - 15 cm pack: 12
			52.44040 μπολ   <i>bowl</i> , 25 cm pack: 6		





## Fish embossed - με ανάγλυφο σχέδιο









	52.84816 πίατο ρηχό   <i>plate</i> , 19 cm pack: 12
	52.84817 πίατο ρηχό   <i>plate</i> , 25 cm pack: 12
	52.84818 πίατο ρηχό   <i>plate</i> , 30 cm pack: 6
	πιατέλα οβάλ   <i>oval platter</i> 52.84819 20x16 cm pack: 6
	52.84821 34x27 cm pack: 6
	52.84823 σαλατιέρα   <i>salad bowl</i> 25 cm pack: 6



## Merid

	πιατέλα ρηχή παραλ/μη <i>platter rectangular</i> 52.52359 34x14 cm σουσκ.: 6
	52.52361 34x18 cm σουσκ.: 6

## Sea food

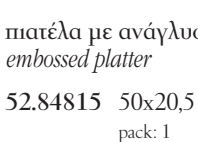
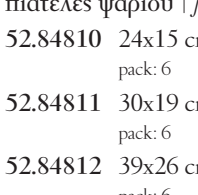
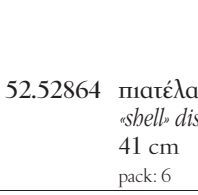
	πιατέλα με ανάγλυφο σχέδιο <i>embossed platter</i> 52.84815 50x20,5 cm pack: 1
	πιατέλες ψαριού   <i>fish dishes</i> 52.84810 24x15 cm pack: 6
	52.84811 30x19 cm pack: 6
	52.84812 39x26 cm pack: 6
	52.52864 πιατέλα «κοχύλι» <i>shell dish</i> 41 cm pack: 6
	52.52863 πιατέλα «κοχύλι» <i>shell dish</i> 41 cm pack: 6
	52.84813 πιατέλα «κοχύλι» <i>shell dish</i> , 24 cm pack: 12
	52.84814 πιατέλα «κοχύλι» <i>shell dish</i> , 34 cm pack: 6
	μπολ «κοχύλι» 52.52861 27 cm pack: 1
	52.52862 36 cm pack: 1
	52.52125 πιάτο οστράκων <i>shell plate</i> 28 cm pack: 6

# Delta



52.56207  
πίατο ρηχό | *plate*  
27 cm  
pack: 12



52.56208  
πίατο ρηχό | *plate*  
30 cm  
pack: 6



52.52117  
πίατο ρηχό | *plate*  
32 cm  
pack: 6



52.52168  
πίατο βαθύ | *deep plate*  
23 cm  
pack: 12



52.52121  
πίατο βαθύ | *deep plate*  
30 cm  
pack: 6



52.52122  
πίατο pasta | *pasta plate*  
«Reno», 26 cm  
pack: 6



52.52126  
πίατο pasta | *pasta plate*  
«Reno», 30 cm  
pack: 6



52.56130  
πιπέλα οβάλ  
*oval platter*, 24x17 cm  
pack: 6



52.56133  
πιπέλα οβάλ  
*oval platter*, 29x20 cm  
pack: 6



52.56136  
πιπέλα οβάλ  
*oval platter*, 34x24 cm  
pack: 6



52.56137  
πιπέλα οβάλ  
*oval platter*, 39x27 cm  
pack: 6



52.56200  
πίατο ρηχό | *plate*  
16 cm  
pack: 12



52.56201  
πίατο ρηχό | *plate*  
17 cm  
pack: 12



52.56202  
πίατο ρηχό | *plate*  
18 cm  
pack: 12



52.56203  
πίατο ρηχό | *plate*  
20 cm  
pack: 12



52.56204  
πίατο ρηχό | *plate*  
22 cm  
pack: 12



52.56205  
πίατο ρηχό | *plate*  
24 cm  
pack: 12



52.56206  
πίατο ρηχό | *plate*  
26 cm  
pack: 12

# αξεσουάρ



52.33078  
μπολ κωνικό  
*conical bowl*,  
12 cm (35 cl)  
pack: 12



52.33080  
μπολ πάγου  
*ice bowl*, «Moscow»  
8 cm | 16 cl  
pack: 12



\*52.84086  
θήκη οδοντογλυφ.  
*tooth pick holder*  
pack: 12

μπολ joker | *joker*

52.44167  
6 cm (3 cl) pack: 24

52.44168  
8 cm (6,5 cl) pack: 24

52.44169  
10 cm (15 cl) pack: 24

52.44170  
12 cm (25 cl) pack: 12

52.44171  
14 cm (66 cl) pack: 6

μπολ | *bowl*

52.44172  
19 cm pack: 12

52.44173  
23 cm pack: 6



52.44152  
μπολ | *bowl*  
«ECE», 18 cm  
pack: 6



52.84017  
αυγοθήκη | *egg cup*  
pack: 12



52.84016  
θήκη χαρτοπετοειτών  
*napkin holder*  
pack: 12



52.84019  
αυγοθήκη | *egg cup*  
13 cm  
pack: 12



52.84011  
μπολ κονοομέ  
*soup bowl*,  
30 cl pack: 12

52.84010  
πιατάκι | *saucer*  
16 cm pack: 12

52.84012  
μπολ | *oatmeal*  
16 cm  
pack: 12

52.92005  
μπολ 2 θέσεων | *double bowl*  
17x8 cm pack: 12



52.84062  
αλατιέρα | *salt shaker*  
pack: 24

52.84063  
πιπεριέρα | *pepper shaker*  
pack: 24



52.92006  
μπολ 3 θέσεων | *triple bowl*  
25x8 cm pack: 12

52.60050  
σταχτοδοχείο  
*ash tray*, 9,5 cm  
pack: 24



\*52.22092  
ανθοδοχείο  
*flower vase*,  
13 cm  
pack: 24



# αξεσουάρ καφέ



52.84015  
τοαγιέρα  
*tea pot*  
37,5 cl  
pack: 12



52.37162  
καφετιέρα  
*coffee pot*  
50 cl  
pack: 6



καφετιέρα  
*coffee pot*  
52.37020  
35 cl pack: 6  
52.37021  
57,5 cl pack: 6  
\*52.37022  
90 cl pack: 6



52.84014  
ζαχαριέρα με καπάκι  
*sugar bowl with lid*  
18 cl | 10 cm  
pack: 12

52.33072  
ζαχαριέρα πορσελάνης  
*porcelain sugar bowl*  
12 cm  
pack: 12



52.27025  
γαλατιέρα  
*creamer*, 12,5 cl  
pack: 6

52.84018  
κύπελο  
μυγ «Elite»  
30 cl  
pack: 12



52.33073  
ζαχαριέρα για φακελ.  
*sugar pack holder*,  
12 cm  
pack: 12



52.84013  
γαλατιέρα/σαλτοιέρα  
*creamer/gravy boat*  
9 cl  
pack: 12

52.27020  
γαλατιέρα  
*creamer*, 10 cl  
pack: 6



52.84612  
φλιτζάνι στοιβαζ.  
*stackable cup*, 9 cl  
pack: 12

52.33074  
ζαχαριέρα για φακελ.  
*sugar pack holder*,  
12 cm  
pack: 12



«Bistro»  
φλιτζ με πιάτο  
*cup with saucer*

52.84198  
7 cl pack: 12

52.84199  
15 cl pack: 12



52.84200  
φλιτζάνι με πιάτο  
*cup with saucer*  
«Jumbo»,  
45 cl (17 cm)  
pack: 12























52.84613  
φλιτζάνι στοιβαζ.  
*stackable cup*, 23 cl  
pack: 12

52.90006  
πιατάκι | *saucer*  
pack: 12













EO

	52.84001 πίατο coupe   <i>coupe plate</i> 15 cm pack: 12		52.84008 πίατο coupe   <i>coupe plate</i> 30 cm pack: 12		52.56154 πατέλα οβάλ <i>oval platter</i> , 29x17 cm pack: 6
	52.84002 πίατο coupe   <i>coupe plate</i> 17 cm pack: 12		52.84009 πίατο coupe   <i>coupe plate</i> 20 cm pack: 12		52.56155 πατέλα οβάλ <i>oval platter</i> , 34x20 cm pack: 6
	52.84003 πίατο coupe   <i>coupe plate</i> 19 cm pack: 12		52.52123 πίατο steak   <i>steak plate</i> 29x28 cm pack: 6		52.56156 πατέλα οβάλ <i>oval platter</i> , 39x24 cm pack: 6
	52.84004 πίατο coupe   <i>coupe plate</i> 21 cm pack: 12		52.56150 πατέλα οβάλ <i>oval platter</i> , 15x9 cm pack: 12		52.56160 μπολ ορθογώνιο <i>rectangular bowl</i> 14x10 cm pack: 12
	52.84005 πίατο coupe   <i>coupe plate</i> 23 cm pack: 12		52.56151 πατέλα οβάλ <i>oval platter</i> , 19x11 cm pack: 6		52.56161 μπολ ορθογώνιο <i>rectangular bowl</i> 17x12 cm pack: 12
	52.84006 πίατο coupe   <i>coupe plate</i> 25 cm pack: 12		52.56152 πατέλα οβάλ <i>oval platter</i> , 24x14 cm pack: 6		52.56162 μπολ ορθογώνιο <i>rectangular bowl</i> 20x16 cm pack: 12
	52.84007 πίατο coupe   <i>coupe plate</i> 28 cm pack: 12		52.56153 πατέλα οβάλ <i>oval platter</i> , 26x15 cm pack: 6		





## Side





	<p>πίατο coupe   <i>coupe plate</i></p> <p>52.85193 17 cm pack: 12</p> <p>52.85031 21 cm pack: 12</p> <p>52.85032 23 cm pack: 12</p>		<p>52.85096 μπολ   <i>bowl</i>, 19 cm pack: 6</p> <p>52.85101 μπολ   <i>bowl</i>, 23 cm pack: 6</p>		<p>52.85131 γαλατιέρα   <i>milk jug</i> 12,5 cl pack: 6</p>
	<p>52.85033 27 cm pack: 12</p> <p>52.85030 30 cm pack: 6</p>		<p>μπολ στοιβαζόμενο <i>bowl stackable</i></p> <p>52.85024 joker, 6 cm pack: 24</p>		<p>52.85130 τσαγιέρα   <i>tea pot</i> 37,5 cl pack: 6</p>
	<p>52.85023 πίατο βαθύ coupe <i>deep coupe plate</i> 20 cm pack: 12</p> <p>52.85034 πίατο pasta   <i>deep pasta</i> 26 cm pack: 6</p> <p>52.85192 πίατο pasta   <i>deep pasta</i> 30 cm pack: 6</p>		<p>52.85025 8 cm pack: 24</p> <p>52.85126 12 cm pack: 12</p> <p>πιπέλα   <i>platter</i></p> <p>52.85036 24x14 cm pack: 6</p> <p>52.85037 29x17 cm pack: 6</p> <p>52.85194 39x24 cm pack: 6</p>		<p>52.85127 κούπα   <i>mug</i> 30 cl pack: 12</p>
					<p>52.85147 φλιτζάνι   <i>cup</i>, 23 cl pack: 12</p> <p>52.85148 πίατο   <i>saucer</i>, 15,5 cm pack: 12</p>

## Avanos Anthracite

	<p>πίατο coupe   <i>coupe plate</i></p> <p>52.85208 17 cm pack: 12</p> <p>52.85090 21 cm pack: 12</p> <p>52.85091 23 cm pack: 12</p> <p>52.85092 27 cm pack: 12</p> <p>52.85095 30 cm pack: 6</p>		<p>πίατο βαθύ coupe <i>deep coupe plate</i></p> <p>52.85093 20 cm pack: 12</p>		<p>μπολ στοιβαζόμενα <i>bowl stackable</i></p> <p>52.85100 joker   <i>bowl</i>, 6 cm pack: 24</p> <p>52.85203 8 cm pack: 24</p> <p>52.85204 12 cm pack: 12</p>	
			<p>πιατέλα   <i>platter</i></p> <p>52.85206 24x14 cm pack: 6</p> <p>52.85207 29x17 cm pack: 6</p>			<p>52.85135 κούπα   <i>mug</i> 30 cl pack: 12</p>
			<p>πίατο pasta   <i>deep pasta</i></p> <p>52.85094 26 cm pack: 6</p> <p>52.85205 30 cm pack: 6</p>			<p>μπολ   <i>bowl</i></p> <p>52.85209 19 cm pack: 6</p> <p>52.85210 23 cm pack: 6</p>











## Avanos Terra

	<p>πίατο coupe   <i>coupe plate</i></p> <p>52.85227 17 cm pack: 12</p> <p>52.85080 21 cm pack: 12</p> <p>52.85081 23 cm pack: 12</p> <p>52.85082 27 cm pack: 12</p> <p>52.85085 30 cm pack: 6</p>		<p>πίατο βαθύ coupe <i>deep coupe plate</i></p> <p>52.85083 20 cm pack: 12</p>		<p>μπολ στοιβαζόμενα <i>bowl stackable</i></p> <p>52.85099 joker   <i>bowl</i>, 6 cm pack: 24</p> <p>52.85222 8 cm pack: 24</p> <p>52.85223 12 cm pack: 12</p>	
			<p>πιατέλα   <i>platter</i></p> <p>52.85225 24x14 cm pack: 6</p> <p>52.85226 29x17 cm pack: 6</p>			<p>52.85134 κούπα   <i>mug</i> 30 cl pack: 12</p>
			<p>πίατο pasta   <i>deep pasta</i></p> <p>52.85084 26 cm pack: 6</p> <p>52.85224 30 cm pack: 6</p>			<p>μπολ   <i>bowl</i></p> <p>52.85228 19 cm pack: 6</p> <p>52.85229 23 cm pack: 6</p>

# Avanos









## Avanos Red









	πίατο coupe   <i>coupe plate</i> 52.85221 17 cm pack: 12 52.85040 21 cm pack: 12 52.85041 23 cm pack: 12 52.85042 27 cm pack: 12 52.85045 30 cm pack: 6
	πίατο pasta   <i>deep pasta</i> 52.85044 26 cm pack: 6 52.85218 30 cm pack: 6
	πίατο βαθύ coupe <i>deep coupe plate</i> 52.85043 20 cm pack: 12
	πιπέλα   <i>platter</i> 52.85219 24x14 cm pack: 6 52.85220 29x17 cm pack: 6
	μπολ   <i>bowl</i> 52.85216 19 cm pack: 6 52.85217 23 cm pack: 6
	μπολ στοιβαζόμενα <i>bowl stackable</i> 52.85097 joker   <i>bowl</i> , 6 cm pack: 24 52.85214 8 cm pack: 24 52.85215 12 cm pack: 12
	52.85136 κούπα   <i>mug</i> 30 cl pack: 12
	52.85145 φλιτζάνι   <i>cup</i> , 23 cl pack: 12 52.85146 πίατο   <i>saucer</i> , 15,5 cm pack: 12



## Avanos Turquoise



















## Avanos Green

	<p>πίατο coupe   <i>coupe plate</i> 52.85213 17 cm pack: 12</p> <p>52.85052 21 cm pack: 12</p> <p>52.85053 23 cm pack: 12</p> <p>52.85054 27 cm pack: 12</p> <p>52.85102 30 cm pack: 6</p>
	<p>πίατο pasta   <i>deep pasta</i> 52.85050 26 cm pack: 6</p> <p>52.85051 30 cm pack: 6</p>
	<p>πίατο βαθύ coupe <i>deep coupe plate</i> 52.85103 20 cm pack: 12</p>
	<p>πιατέλα   <i>platter</i> 52.85056 24x14 cm pack: 6</p> <p>52.85058 29x17 cm pack: 6</p>
	<p>μπολ   <i>bowl</i> 52.85212 19 cm pack: 6</p> <p>52.85060 23 cm pack: 6</p>
	<p>μπολ στοιβαζόμενα <i>bowl stackable</i> 52.85061 joker   bowl, 6 cm pack: 24</p> <p>52.85211 8 cm pack: 24</p> <p>52.85112 12 cm pack: 12</p>
	<p>52.85132 κούπα   <i>mug</i> 30 cl pack: 12</p>
	<p>52.85137 φλιτζάνι   <i>cup</i>, 23 cl pack: 12</p> <p>52.85138 πίατο   <i>saucer</i>, 15,5 cm pack: 12</p>

	<p>πίατο coupe   <i>coupe plate</i> 52.85200 17 cm pack: 12</p> <p>52.85070 21 cm pack: 12</p> <p>52.85071 23 cm pack: 12</p> <p>52.85072 27 cm pack: 12</p> <p>52.85075 30 cm pack: 6</p>
	<p>πίατο pasta   <i>deep pasta</i> 52.85074 26 cm pack: 6</p> <p>52.85197 30 cm pack: 6</p>
	<p>πίατο βαθύ coupe <i>deep coupe plate</i> 52.85073 20 cm pack: 12</p>
	<p>πιατέλα   <i>platter</i> 52.85198 24x14 cm pack: 6</p> <p>52.85199 29x17 cm pack: 6</p>
	<p>μπολ   <i>bowl</i> 52.85201 19 cm pack: 6</p> <p>52.85202 23 cm pack: 6</p>
	<p>μπολ στοιβαζόμενα <i>bowl stackable</i> 52.85098 joker   bowl, 6 cm pack: 24</p> <p>52.85195 8 cm pack: 24</p> <p>52.85196 12 cm pack: 12</p>
	<p>52.85133 κούπα   <i>mug</i> 30 cl pack: 12</p>
	<p>52.85139 φλιτζάνι   <i>cup</i>, 23 cl pack: 12</p> <p>52.85140 πίατο   <i>saucer</i>, 15,5 cm pack: 12</p>

















# Arnim

	<p>πίατο ρηχό raised <i>raised plate</i></p> <p>52.85172 21 cm pack: 12</p>		<p>52.85176 πίατο βαθύ <i>deep plate</i></p> <p>26 cm pack: 6</p>
	<p>52.85173 25 cm pack: 12</p>		<p>52.85252 πιπέλα παραλ/μη <i>rectangular platter</i></p> <p>29x17 cm pack: 6</p>
	<p>52.85174 27 cm pack: 6</p>		<p>52.85253 33x15 cm pack: 6</p>
	<p>52.85175 29 cm pack: 6</p>		<p>52.85254 34x18 cm pack: 6</p>
	<p>52.85248 πίατο coupe   <i>coupe plate</i></p> <p>21 cm pack: 12</p>		<p>52.85255 37x25 cm pack: 6</p>
	<p>52.85249 25 cm pack: 12</p>		<p>52.85256 μπολ   <i>bowl</i></p> <p>12 cm pack: 15</p>
	<p>52.85250 27 cm pack: 6</p>		<p>52.85257 μπολ   <i>bowl</i></p> <p>10 cm pack: 12</p>
	<p>52.85263 πίατο organic roden <i>organic roden plate,</i></p> <p>20 cm pack: 12</p>		<p>52.85258 μπολ   <i>bowl</i></p> <p>10x8 cm pack: 12</p>
	<p>52.85264 25 cm pack: 12</p>		
	<p>52.85265 30 cm pack: 6</p>		



# Blue voyage

	<p>πίατο ρηχό raised <i>raised plate</i></p> <p>52.85177 21 cm pack: 12</p>		<p>πίατο coupe <i>coupe plate</i></p>		<p>πιπέλα παραλ/μη <i>rectangular platter</i></p> <p>52.85240 29x17 cm pack: 6</p>
	<p>52.85178 25 cm pack: 12</p>		<p>52.85236 21 cm pack: 12</p>		<p>52.85242 34x18 cm pack: 6</p>
	<p>52.85179 27 cm pack: 6</p>		<p>52.85237 25 cm pack: 12</p>		<p>52.85243 37x25 cm pack: 6</p>
	<p>52.85180 29 cm pack: 6</p>		<p>52.85238 27 cm pack: 6</p>		<p>52.85245 μπολ   <i>bowl</i></p> <p>10 cm pack: 12</p>
	<p>52.85181 πίατο βαθύ <i>deep plate</i></p> <p>26 cm pack: 6</p>		<p>52.85244 μπολ   <i>bowl</i></p> <p>15 cm pack: 12</p>		<p>52.85246 μπολ   <i>bowl</i></p> <p>10x8 cm pack: 12</p>

# Bodrum matt black



52.85001  
πίατο coupe | coupe plate  
17 cm  
pack: 12



52.85165  
πίατο coupe | coupe plate  
19 cm  
pack: 12



52.85002  
πίατο coupe | coupe plate  
21 cm  
pack: 12



52.85183  
πίατο coupe | coupe plate  
23 cm  
pack: 12



52.85166  
πίατο coupe | coupe plate  
27 cm  
pack: 6



52.85184  
πίατο coupe | coupe plate  
30 cm  
pack: 6



52.85169  
πίατο ρηχό | plate  
24x24 cm  
pack: 12



52.85004  
πίατο βαθύ coupe  
deep coupe plate  
20 cm  
pack: 12



πίατο βαθύ  
deep plate  
26 cm  
pack: 6



52.85185  
πίατο βαθύ  
deep plate  
30 cm  
pack: 6



52.85167  
μπολ | bowl  
23 cm  
pack: 6



52.85168  
μπολ | bowl  
17x17 cm  
pack: 6



52.85170  
μπολ | bowl  
13x13 cm  
pack: 14



52.85186  
μπολ joker | bowl  
6 cm  
pack: 12



52.85189  
κούπα | mug  
30 cl  
pack: 12



52.85187  
φλιτζάνι | cup, 23 cl  
pack: 12

52.85188  
πίατο | saucer, 15,5 cm  
pack: 12





## Jade



30.71227 781400  
πίατο flat, 20 cm  
pack: 4/24



30.71228 781401  
πίατο flat, 27,5 cm  
pack: 4/12



30.71229 781402  
μπολ ρηχό  
12 cm | 4 cm  
pack: 4/48









30.71230 781403  
μπολ ρηχό  
20 cm | 6,5 cm  
pack: 4/16

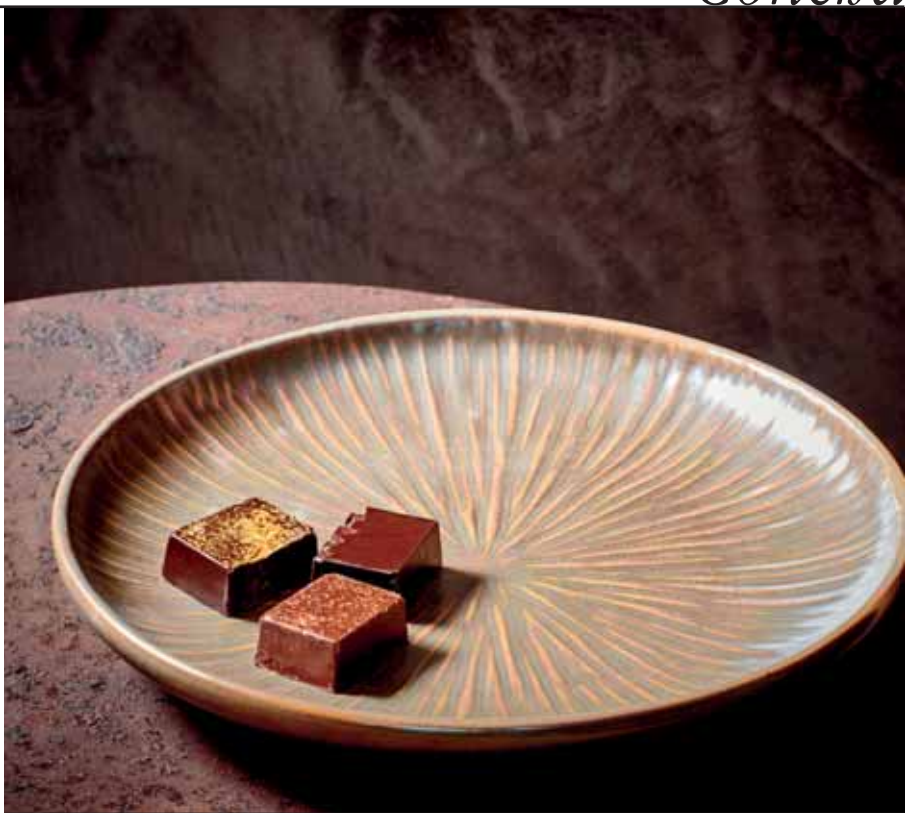

30.71231 781404  
μπολ ρηχό  
25 cm | 6 cm  
pack: 4/12

# Concha

	<b>*30.71389</b> 781600 πίατο ρηχό   <i>plate</i> 20,5 cm pack: 4/16				
	<b>*30.71390</b> 781601 πίατο ρηχό   <i>plate</i> 26,5 cm pack: 2/12				
	<b>*30.71391</b> 781610 πίατο βαθύ   <i>deep plate</i> 25 cm   5 cm pack: 2/10				
	<b>*30.71392</b> 781611 πίατο βαθύ   <i>deep plate</i> 36 cm   4,5 cm pack: 1/4				
	<b>*30.71393</b> 781615 πίατο οβάλ   <i>oval plate</i> 24x14,5 cm   3 cm pack: 4/16			<b>*30.71394</b> 781616 πίατο οβάλ   <i>oval plate</i> 35,5x22 cm   3,5 cm pack: 2/8	

# Cala

	<b>*30.71385</b> 780311 πίατο ρηχό   <i>plate</i> 21,5 cm pack: 4/24		<b>*30.71384</b> 780310 πίατο βαθύ   <i>deep plate</i> 23 cm   3,5 cm pack: 4/24	
	<b>*30.71383</b> 780309 πίατο ρηχό   <i>plate</i> 24,5 cm pack: 4/16		<b>*30.71382</b> 780308 πίατο βαθύ   <i>deep plate</i> 25,5 cm   4 cm pack: 4/16	
	<b>*30.71381</b> 780307 πίατο ρηχό   <i>plate</i> 28,5 cm pack: 4/12		<b>*30.71380</b> 780306 πίατο βαθύ   <i>deep plate</i> 28,5 cm   6 cm pack: 4/12	
	<b>*30.71379</b> 780305 πίατο ρηχό   <i>plate</i> 33 cm pack: 4/8		<b>*30.71378</b> 780304 πίατο βαθύ   <i>deep plate</i> 34,5 cm   5,5 cm pack: 4/8	
			<b>*30.71388</b> 780314 μπολ   <i>bowl</i> 10,5 cm   5,5 cm pack: 4/72	
			<b>*30.71387</b> 780313 μπολ   <i>bowl</i> 13 cm   6,5 cm pack: 4/48	
			<b>*30.71386</b> 780312 μπολ   <i>bowl</i> 16 cm   6,5 cm pack: 4/32	





### Mosaic olive

	30.71625 606540 πίατο ρηχό   <i>plate</i> 12 cm   1,5 cm pack: 6/24
	30.71609 606541 πίατο ρηχό   <i>plate</i> 21 cm   1,5 cm pack: 4/12
	30.71610 606542 πίατο ρηχό   <i>plate</i> 27 cm   2 cm pack: 4/8
	30.71624 606545 πίατο βαθύ   <i>deep plate</i> 21,5 cm   4,5 cm pack: 2/12
	30.71623 606546 πίατο βαθύ   <i>deep plate</i> 24,5 cm   5 cm pack: 2/8
	30.71621 606551 μπολ   <i>bowl</i> 19,5 cm   6,5 cm pack: 2/8
	30.71622 606550 μπολ   <i>bowl</i> 10 cm   6 cm pack: 6/18

### Mosaic almond

	30.71590 606555 πίατο ρηχό   <i>plate</i> 12 cm   1,5 cm pack: 6/24
	30.71591 606556 πίατο ρηχό   <i>plate</i> 21 cm   1,5 cm pack: 4/12
	30.71599 606557 πίατο ρηχό   <i>plate</i> 27 cm   2 cm pack: 4/8
	30.71600 606560 πίατο βαθύ   <i>deep plate</i> 21,5 cm   4,5 cm pack: 2/12
	30.71620 606561 πίατο βαθύ   <i>deep plate</i> 24,5 cm   5 cm pack: 2/8
	30.71611 606566 μπολ   <i>bowl</i> 19,5 cm   6,5 cm pack: 2/8
	30.71619 606565 μπολ   <i>bowl</i> 10 cm   6 cm pack: 6/18

### Mosaic aubergine

	30.71618 606570 πίατο ρηχό   <i>plate</i> 12 cm   1,5 cm pack: 6/24
	30.71617 606571 πίατο ρηχό   <i>plate</i> 21 cm   1,5 cm pack: 4/12
	30.71616 606572 πίατο ρηχό   <i>plate</i> 27 cm   2 cm pack: 4/8
	30.71615 606575 πίατο βαθύ   <i>deep plate</i> 21,5 cm   4,5 cm pack: 2/12
	30.71614 606576 πίατο βαθύ   <i>deep plate</i> 24,5 cm   5 cm pack: 2/8
	30.71612 606581 μπολ   <i>bowl</i> 19,5 cm   6,5 cm pack: 2/8
	30.71613 606580 μπολ   <i>bowl</i> 10 cm   6 cm pack: 6/18

# Halo

	<b>*30.71524</b> 605070 πιάτο ρηχό   <i>plate</i> 20 cm pack: 4/16
	<b>*30.71572</b> 605071 πιάτο ρηχό   <i>plate</i> 25,5 cm pack: 4/16
	<b>*30.71525</b> 605072 πιάτο ρηχό   <i>plate</i> 28 cm pack: 4/12
	<b>*30.71596</b> 605077 πιάτο ρηχό   <i>plate</i> 40 cm   5 cm pack: 2/6



	<b>*30.71526</b> 605075 πιάτο οβάλ   <i>servicing dish</i> 25,5x17 cm pack: 4/16		<b>*30.71527</b> 605076 πιατέλα οβάλ <i>servicing dish</i> 40x25,5 cm pack: 4/8
--	---	--	---

# Usko

	<b>*30.71397</b> 604400 πιάτο ρηχό   <i>plate</i> 20 cm pack: 4/24
	<b>*30.71398</b> 604401 πιάτο ρηχό   <i>plate</i> 26 cm pack: 4/16
	<b>*30.71404</b> 604408 πιατέλα   <i>platter</i> 30 cm   4,5 cm pack: 4/12
	<b>*30.71403</b> 604407 πιάτο βαθύ οβάλ <i>deep plate oval</i> 30x21 cm   3,7/5,5 cm pack: 4/12
	<b>*30.71401</b> 604405 πιάτο βαθύ   <i>deep plate</i> 20 cm   5 cm pack: 4/16

	<b>*30.71402</b> 604406 πιάτο βαθύ   <i>deep plate</i> 24 cm   6 cm pack: 2/12
	<b>*30.71407</b> 604412 μπολ   <i>bowl</i> 19,5 cm   8 cm pack: 4/24
	<b>*30.71405</b> 604410 μπολ   <i>bowl</i> 11 cm   5 cm pack: 8/48
	<b>*30.71406</b> 604411 μπολ   <i>bowl</i> 14,5 cm   6 cm pack: 4/24

	<b>*30.71410</b> 604420 φλιτζάνι   <i>cup</i> , 10 cl pack: 8/48
	<b>*30.71411</b> 604421 πιατάκι   <i>plate</i> , 11 cm pack: 8/48
	<b>*30.71412</b> 604422 φλιτζάνι   <i>cup</i> , 16 cl pack: 4/48
	<b>*30.71413</b> 604423 πιατάκι   <i>plate</i> , 14,5 cm pack: 4/48





## Black Dusk

	30.71187 604500 πίατο ρηχό   plate 21 cm pack: 4/36
	30.71188 604501 πίατο ρηχό   plate 27 cm pack: 4/16
	30.71189 604502 πίατο βαθύ   deep plate 24,5 cm   4 cm pack: 4/24
	30.71190 604503 πίατο τετράγωνο square plate, 10x10 cm pack: 4/144
	30.71156 604504 πίατο τετράγωνο square plate, 26x26 cm pack: 4/16
	30.71194 604511 μπολ   bowl 14 cm   7,5 cm pack: 4/36
	30.71195 604510 μπολ   bowl 10 cm   6 cm pack: 4/48



	πίατα ορθογώνια rectangular plates		30.71157 604507 μπολ   bowl 4,5 cm   4 cm pack: 4/288
	30.71191 604505 22x10 cm pack: 4/36		30.71258 604509 μπολ   bowl 7,5 cm   2,5 cm pack: 4/216
	30.71192 604506 28x20 cm pack: 4/16		30.71197 604514 φιάλη σάκε sake pourer, 20,5 cl pack: 4/72
	30.71193 604512 σαλατιέρα   bowl 18 cm   6 cm orpack: 4/36		30.71257 604513 φιάλη σόγιας soya sauce pourer, 20 cl pack: 4/72
	30.71196 604508 μπολ   bowl 6,5 cm   5 cm pack: 4/192		

## Speckled Dusk

	*30.71198 604550 πίατο ρηχό   plate 21 cm pack: 4/36
	*30.71199 604551 πίατο ρηχό   plate 27 cm pack: 4/16
	*30.71200 604552 πίατο βαθύ   deep plate 24,5 cm   4 cm pack: 4/24
	πίατα τετράγωνα square plates
	*30.71201 604553 10 cm pack: 4/144
	*30.71202 604554 26 cm pack: 4/16
	*30.71206 604561 μπολ   bowl 14 cm   7,5 cm pack: 4/36
	*30.71207 604560 μπολ   bowl 10 cm   6 cm pack: 4/48

	πίατα ορθογώνια rectangular plates		*30.71209 604557 μπολ, 4,5 cm   4 cm pack: 4/288
	*30.71203 604555 22x10 cm pack: 4/36		*30.71240 604559 μπολ, 7,5 cm   2,5 cm pack: 4/216
	*30.71204 604556 28x20 cm pack: 4/16		*30.71210 604564 φιάλη σάκε sake pourer, 20,5 cl pack: 4/72
	*30.71205 604562 σαλατιέρα   bowl 18 cm   6 cm pack: 4/36		*30.71241 604563 φιάλη σόγιας soya sauce pourer, 20 cl pack: 4/72
	*30.71208 604558 μπολ   bowl 6,5 cm   5 cm pack: 4/192		





Umi

Πορσελάνες















101

F·2·D

	*30.71658 606801 πίατο ρηχό   <i>plate</i> 18x17 cm pack: 4		*30.71662 606805 δίσκος   <i>serving dish</i> 29x9 cm pack: 4		*30.71666 606809 δίσκος   <i>serving dish</i> 41x13 cm pack: 4
	*30.71660 606802 πίατο ρηχό   <i>plate</i> 25x24 cm pack: 4		*30.71663 606806 δίσκος   <i>serving dish</i> 32x9 cm pack: 4		*30.71667 606810 μπολ   <i>bowl</i> 7,5 cm   2 cm pack: 4
	*30.71661 606803 πίατο ρηχό   <i>plate</i> 30x18 cm pack: 4		*30.71664 606807 δίσκος   <i>serving dish</i> 35x15 cm   2 cm pack: 4		*30.71668 606811 μπολ   <i>bowl</i> 6 cm   4 cm pack: 4
	*30.71659 606804 δίσκος   <i>serving dish</i> 21x21 cm pack: 4		*30.71665 606808 δίσκος   <i>serving dish</i> 39x8 cm   3 cm pack: 4		*30.71669 606812 μπουκάλι σάκε <i>sake pourer</i> 30 cl pack: 4



# Aurora

	*30.71455 606002 πίατο ρηχό   <i>plate</i> 13 cm pack: 4/72		*30.71457 606004 πίατο βαθύ   <i>deep plate</i> 24 cm   4 cm pack: 2/18		*30.71462 606011 φλιτζάνι   <i>cup</i> , 9 cl pack: 4/96
	*30.71454 606001 πίατο ρηχό   <i>plate</i> 19,5 cm pack: 4/36		*30.71459 606008 μπολ   <i>bowl</i> 10 cm   5 cm pack: 4/72		*30.71463 606012 πιατάκι   <i>plate</i> , 12 cm pack: 4/96
	*30.71453 606000 πίατο ρηχό   <i>plate</i> 26 cm pack: 2/18		*30.71458 606007 μπολ   <i>bowl</i> 13 cm   5,5 cm pack: 4/48		*30.71460 606009 φλιτζάνι   <i>cup</i> , 20 cl pack: 4/72
	*30.71456 606003 πίατο ρηχό   <i>plate</i> 30,5 cm pack: 2/12		*30.71465 606014 σαλτσιέρα   <i>gravy boat</i> 10 cl pack: 4/144		*30.71461 606010 πιατάκι   <i>plate</i> , 14 cm pack: 4/72
			*30.71464 606013 γαλατιέρα   <i>creamer</i> 28 cl pack: 4/48		
			*30.71466 606015 γαλατιέρα   <i>creamer</i> 6,5 cm   7,5 cm pack: 4/96		



	<b>*30.71558</b> 605150 πίατο coupe   <i>plate coupe</i> 20 cm   3 cm pack:4/24		<b>*30.71562</b> 605155 πίατο βαθύ coupe <i>coupe deep plate</i> 24 cm   5,5 cm pack:4/12	
	<b>*30.71557</b> 605151 πίατο coupe   <i>plate coupe</i> 26 cm   3 cm pack:4/12		<b>*30.71559</b> 605160 μπολ   <i>bowl</i> 10 cm   5 cm pack:4/48	
	<b>*30.71516</b> 605152 πίατο coupe   <i>plate coupe</i> 29 cm   3 cm pack:4/8		<b>*30.71517</b> 605161 μπολ   <i>bowl</i> 15 cm   8,5 cm pack:4/16	
	<b>*30.71515</b> 605156 πίατο βαθύ   <i>deep plate</i> 28/17 cm   7 cm pack:2/12			

# Structo brown

	<b>*30.71419</b> 604870 πίατο raised   <i>raised plate</i> 20,5 cm pack: 4/24		<b>*30.71424</b> 604881 μπολ   <i>bowl</i> 10 cm   5,5 cm pack: 4/48	
	<b>*30.71420</b> 604871 πίατο raised   <i>raised plate</i> 28 cm pack: 4/16		<b>*30.71425</b> 604882 μπολ   <i>bowl</i> 14 cm   6,5 cm pack: 4/24	
	<b>*30.71421</b> 604875 πιατέλα   <i>serving plate</i> 22x10 cm pack: 4/24	<b>*30.71427</b> 604890 φλιτζάνι   <i>cup</i> , 8 cl pack: 4/64		
	<b>*30.71422</b> 604876 πιατέλα   <i>serving plate</i> 28,5x20 cm pack: 4/16	<b>*30.71428</b> 604891 φλιτζάνι   <i>cup</i> , 14 cl pack: 4/64		
	<b>*30.71423</b> 604880 μπολ   <i>bowl</i> 7 cm   4 cm pack: 4/64	<b>*30.71430</b> 604895 πιατάκι   <i>plate</i> , 14 cm pack: 4/48	<b>*30.71429</b> 604892 φλιτζάνι   <i>cup</i> , 20 cl pack: 4/64	
			<b>*30.71431</b> 604896 πιατάκι   <i>plate</i> , 14 cm pack: 4/48	

# Escura



**\*30.71024** 604016  
 πιάτο raised | *raised plate*  
 20 cm | 2 cm  
 pack: 6/24



**\*30.71025** 604001  
 πιάτο raised | *raised plate*  
 26 cm | 2,5 cm  
 pack: 6/18



**\*30.71026** 604015  
 πιάτο raised | *raised plate*  
 28,5 cm | 2,5 cm  
 pack: 6/12



**\*30.71027** 604011  
 πιατέλα | *platter*  
 30,5 cm | 4,5 cm  
 pack: 6/12



**\*30.71069** 604002  
 πιατέλα οβάλ  
*oval platter*  
 31x20,5 cm | 4 cm  
 pack: 8/16



**\*30.71063** 604017  
 πιατέλα οβάλ  
*oval platter*  
 33x22,5 cm | 3,5 cm  
 pack: 6/12



**\*30.71169** 604000  
 πιάτο raised | *raised plate*  
 13,5 cm | 2 cm  
 pack: 12/48



**\*30.71068** 604004  
 πιάτο βαθύ | *deep plate*  
 22 cm | 4,5 cm  
 pack: 8/16



**\*30.71028** 604003  
 πιάτο βαθύ | *deep plate*  
 20,5 cm | 6 cm  
 pack: 8/16



**\*30.71029** 604007  
 μπόλ | *bowl*  
 15,5 cm | 4,5 cm  
 pack: 6/36



**\*30.71170** 604008  
 μπόλ | *bowl*  
 17,5 cm | 3,5 cm  
 pack: 6/36



**\*30.71030** 604009  
 μπόλ | *bowl*  
 22,5 cm | 4,5 cm  
 pack: 8/16



**\*30.71031** 604005  
 μπόλ | *bowl*  
 11,5 cm | 5 cm  
 pack: 6/48



**\*30.71033** 604010  
 μπόλ | *bowl*  
 19,5 cm | 8 cm  
 pack: 6/24















**\*30.71032** 604006  
 μπόλ | *bowl*  
 12,5 cm | 4 cm  
 pack: 12/48



**\*30.71062** 604012  
 φιάλες λαδιού ξιδιού  
*oil vinegar bottles*, 16 cl  
 pack: 6/72



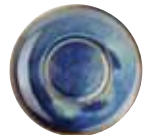





























	<b>*30.71134</b> 604100 πίατο raised   <i>raised plate</i> 20,5 cm   2,5 cm pack: 4/24		<b>*30.71275</b> 604108 πίατο βαθύ οβάλ <i>deep oval plate</i> 30x21 cm   3,7/5,5 cm pack: 4/12		<b>*30.71186</b> 604106 μπολ   <i>bowl</i> 26 cm   7,3 cm pack: 2/12
	<b>*30.71135</b> 604101 πίατο raised   <i>raised plate</i> 26 cm   2,7cm pack: 4/12		<b>*30.71276</b> 604109 μπολ   <i>bowl</i> 6,5 cm   3 cm pack: 12/96		<b>*30.71277</b> 604110 φλιτζάνι   <i>cup</i> 9 cl pack: 4/64
	<b>*30.71132</b> 604102 πίατο raised   <i>raised plate</i> 28,5 cm   3 cm pack: 4/12		<b>*30.71183</b> 604103 μπολ   <i>bowl</i> 10 cm   4,2 cm pack: 4/48		<b>*30.71280</b> 604111 πιτάκι   <i>plate</i> 12,5 cm pack: 8/72
	<b>*30.71274</b> 604107 πίατο βαθύ   <i>deep plate</i> 27,5 cm   5,8 cm pack: 2/12		<b>*30.71184</b> 604104 μπολ   <i>bowl</i> 18 cm   6,3 cm pack: 4/16		<b>*30.71278</b> 604112 κούπα   <i>cup</i> 20 cl pack: 4/24
			<b>*30.71185</b> 604105 μπολ   <i>bowl</i> 23 cm   7 cm pack: 4/12		<b>*30.71279</b> 604113 πιτάκι   <i>plate</i> 14,5 cm pack: 8/48





# Terra porcelain - Matt grey

	<b>34.60170</b> CP-PMG19 πίατο ρηχό coupe <i>coupe plate</i> 19 cm   2,5 cm pack: 6		<b>*34.60445</b> LP-PMG18 πίατο raised χαμηλό <i>low presentation plate</i> 18 cm   2,1 cm pack: 6		<b>*34.60305</b> BW-PMG11 μπολ   <i>round bowl</i> 11,5 cm pack: 6	
	<b>34.60171</b> CP-PMG24 πίατο ρηχό coupe <i>coupe plate</i> 24 cm   2,6 cm pack: 6		<b>*34.60446</b> LP-PMG21 πίατο raised χαμηλό <i>low presentation plate</i> 21 cm   2,2 cm pack: 6			<b>34.60306</b> BW-PMG12 μπολ   <i>round bowl</i> 12,5 cm pack: 6
	<b>34.60172</b> CP-PMG27 πίατο ρηχό coupe <i>coupe plate</i> 27 cm   3 cm pack: 6		<b>*34.60451</b> LP-PMG25 πίατο raised χαμηλό <i>low presentation plate</i> 25 cm   2,2 cm pack: 6			<b>*34.60447</b> RAM-PMG1 ραμκέν   <i>ramekin</i> 4,5 cl   1,5 oz pack: 12
	<b>*34.60395</b> CP-PMG30 πίατο ρηχό coupe <i>coupe plate</i> 30 cm   3,5 cm pack: 6		<b>*34.60402</b> PB-PMG13 μπολ παρουσίασης <i>presentation bowl</i> 13 cm   4,2 cm pack: 6			<b>34.60303</b> RAM-PMG2 ραμκέν   <i>ramekin</i> 7 cl   2,5 oz pack: 12
	<b>*34.60396</b> DC-PMG21 πίατο βαθύ coupe <i>deep coupe plate</i> 21 cm   3,5 cm pack: 6		<b>34.60403</b> PB-PMG18 μπολ παρουσίασης <i>presentation bowl</i> 18 cm   4,2 cm pack: 6			<b>*34.60218</b> RAM-PMG4 ραμκέν   <i>ramekin</i> 13 cl   4,5 oz pack: 12
	<b>34.60397</b> DC-PMG25 πίατο βαθύ coupe <i>deep coupe plate</i> 25 cm   4 cm pack: 6		<b>34.60404</b> PB-PMG21 μπολ παρουσίασης <i>presentation bowl</i> 20,5 cm   4,2 cm pack: 6			<b>*34.60452</b> DP-PMG3 dip   <i>dip pot</i> 8,5 cl (5,8 cm   5,8 cm) pack: 12
	<b>34.60398</b> DC-PMG28 πίατο βαθύ coupe <i>deep coupe plate</i> 28 cm   5 cm pack: 6		<b>34.60176</b> CB-PMG20 πίατο βαθύ   <i>deep plate</i> 20 cm pack: 6			<b>*34.60448</b> DP-PMG5 dip   <i>dip pot</i> 16 cl (7,3 cm   7 cm) pack: 12
	<b>34.60217</b> PR-PMG18 πίατο raised <i>raised plate</i> 18 cm   2,6 cm pack: 6		<b>34.60187</b> CB-PMG23 πίατο βαθύ   <i>deep plate</i> 23 cm pack: 6			<b>34.60408</b> JUG-PMG9 σαλτσιέρα <i>sauce boat</i> , 9 cl pack: 12
	<b>34.60185</b> PR-PMG21 πίατο raised <i>raised plate</i> 20,5 cm   2,9 cm pack: 6		<b>34.60210</b> CB-PMG27 πίατο βαθύ   <i>deep plate</i> 27,5 cm pack: 6			
	<b>34.60186</b> PR-PMG26 πίατο raised <i>raised plate</i> 26 cm   3,3 cm pack: 6		<b>*34.60405</b> CN-PMG14 μπολ κωνικό <i>conical bowl</i> 14 cm   5 cm pack: 6			
			<b>*34.60406</b> CN-PMG16 μπολ κωνικό <i>conical bowl</i> 16 cm   6 cm pack: 6			
			<b>*34.60407</b> CN-PMG19 μπολ κωνικό <i>conical bowl</i> 19,5 cm   7 cm pack: 6			





## Terra porcelain - Matt grey



 \*34.60173 RP-PMG24  
πίατο παραλ/μο  
rectangular plate  
24x16,5 cm  
pack: 12

 34.60174 RP-PMG29  
πίατο παραλ/μο  
rectangular plate  
29x19,5 cm  
pack: 6

 \*34.60175 RP-PMG34  
πίατο παραλ/μο  
rectangular plate  
34,5x23,5 cm  
pack: 6

 \*34.60399 NR-PMG27  
πιπέλα παραλ. στενή  
narrow rectangular platter  
27x12,5 cm  
pack: 6

 34.60400 NR-PMG30  
πιπέλα παραλ. στενή  
narrow rectangular platter  
30x14 cm  
pack: 6

 34.60401 NR-PMG36  
πιπέλα παραλ. στενή  
narrow rectangular platter  
36x16,5 cm  
pack: 6

 \*34.60450 NR-PMG32  
πιπέλα παραλ.  
rectangular platter  
30x20 cm  
pack: 3

 \*34.60409 CUP-PMG9  
φλιτζάνι espresso  
espresso cup, 9 cl  
pack: 6

 \*34.60410 SCR-PMG11  
πιτάκι | saucer, 11 cm  
pack: 6

 \*34.60411 CUP-PMG28  
φλιτζάνι καφέ  
coffee cup, 28,5 cl  
pack: 6

 \*34.60412 SCR-PMG11  
πιτάκι | saucer, 14,5 cm  
pack: 6













 \*34.60449 TP-PMG50  
τσαγιέρα | teapot  
50 cl  
pack: 6

 \*34.60231 CC-PMG32  
κούπα χωρίς χέρι  
chip cup, 32 cl  
pack: 6

 \*34.60339 MUGPMG32  
κούπα με χέρι  
mug, 32 cl  
pack: 6



## Terra porcelain - Seafoam

	<b>34.60473</b> CP-PSF19 πίατο ρηχό coupe <i>coupe plate</i> 19 cm pack: 6		<b>34.60470</b> PR-PSF18 πίατο raised <i>raised plate</i> 18 cm   2,6 cm pack: 6		<b>*34.60478</b> NR-PSF36 πίατο παραλλ/μο <i>rectangular plate</i> 36x16,5 cm pack: 6
	<b>34.60474</b> CP-PSF24 πίατο ρηχό coupe <i>coupe plate</i> 24 cm pack: 6		<b>34.60471</b> PR-PSF21 πίατο raised <i>raised plate</i> 21 cm   2,9 cm pack: 6		<b>34.60479</b> NR-PSF32 πίατο παραλλ/μο <i>rectangular plate</i> 30x20 cm pack: 3
	<b>34.60475</b> CP-PSF27 πίατο ρηχό coupe <i>coupe plate</i> 27,5 cm pack: 6		<b>34.60472</b> PR-PSF26 πίατο ρηχό flat <i>plate flat</i> 26 cm   3,3 cm pack: 6		
	<b>34.60480</b> CB-PSF20 πίατο βαθύ <i>deep plate</i> 20 cm   5,3 cm pack: 6		<b>*34.60476</b> NR-PSF27 πίατο παραλλ/μο <i>rectangular plate</i> 27x12,5 cm pack: 6		
	<b>34.60481</b> CB-PSF23 πίατο βαθύ <i>deep plate</i> 23 cm   6 cm pack: 6		<b>*34.60477</b> NR-PSF30 πίατο παραλλ/μο <i>rectangular plate</i> 30x14 cm pack: 6		





 \*34.60482 BW-PSF11  
μπολ | *round bowl*  
11,5 cm | 5,5 cm  
pack: 6

 \*34.60488 TP-PSF50  
τοαγιέρα | *teapot*  
50 cl  
pack: 6

 34.60483 BW-PSF12  
μπολ | *round bowl*  
12,5 cm | 6,5 cm  
pack: 6

 \*34.60490 CUP-PSF9  
φλιτζάνι espresso  
*espresso cup*, 9 cl  
pack: 6

 \*34.60484 RAM-PSF1  
ραμικέν | *ramekin*  
4,5 cl (6,2 cm | 3,5 cm)  
pack: 12

 \*34.60491 SCR-PSF11  
πιτάκι | *saucer*, 11 cm  
pack: 6

 34.60485 RAM-PSF2  
ραμικέν | *ramekin*  
7 cl (6,7 cm | 3,6 cm)  
pack: 12

 \*34.60492 CUP-PSF28  
φλιτζάνι καφέ  
*coffee cup*, 28,5 cl  
pack: 6

 34.60486 RAM-PSF4  
ραμικέν | *ramekin*  
13 cl (7,8 cm | 4,3 cm)  
pack: 12

 \*34.60493 SCR-PSF14  
πιτάκι | *saucer*, 14,5 cm  
pack: 6

 \*34.60494 JUG-PSF9  
σαλτσιέρα  
*sauce boat*, 9 cl  
pack: 12

 \*34.60489 MUG-PSF32  
κούπα με χέρι  
*mug*, 30 cl  
pack: 6

 \*34.60487 CC-PSF32  
κούπα χωρίς χέρι  
*chip cup*, 32 cl  
pack: 6





## Terra porcelain - Black

	<b>*34.60212</b> CP-PBK19 πίατο ρηχό coupe <i>coupe plate</i> 19 cm pack: 6		<b>34.60191</b> CB-PBK20 πίατο βαθύ <i>deep plate</i> 20 cm pack: 6		<b>*34.60337</b> MUG-PBK32 κούπα με χέρι <i>mug</i> , 32 cl pack: 6
	<b>34.60190</b> CP-PBK24 πίατο ρηχό coupe <i>coupe plate</i> 24 cm pack: 6		<b>34.60192</b> CB-PBK23 πίατο βαθύ <i>deep plate</i> 23 cm pack: 6		<b>*34.60203</b> BW-PBK11 μπολ   <i>round bowl</i> 11,5 cm pack: 6
	<b>34.60213</b> CP-PBK27 πίατο ρηχό coupe <i>coupe plate</i> 27,5 cm pack: 6		<b>34.60216</b> CB-PBK27 πίατο βαθύ <i>deep plate</i> 27,5 cm pack: 6		<b>34.60338</b> BW-PBK12 μπολ   <i>round bowl</i> 12,5 cm pack: 6
	<b>*34.60211</b> PR-PBK18 πίατο ρηχό flat <i>plate flat</i> 18 cm pack: 6		<b>*34.60193</b> RP-PBK24 πίατο παραλλ/μο <i>rectangular plate</i> 24x16,5 cm pack: 12		<b>*34.60204</b> RAM-PBK2 ραμκέν   <i>ramekin</i> 7 cl   2,5 oz pack: 12
	<b>34.60188</b> PR-PBK21 πίατο raised <i>raised plate</i> 21 cm pack: 6		<b>34.60214</b> RP-PBK29 πίατο παραλλ/μο <i>rectangular plate</i> 29x19,5 cm pack: 6		<b>34.60194</b> RAM-PBK4 ραμκέν   <i>ramekin</i> 13 cl   4,5 oz pack: 12
	<b>34.60189</b> PR-PBK26 πίατο raised <i>raised plate</i> 26 cm pack: 6		<b>*34.60215</b> RP-PBK34 πίατο παραλλ/μο <i>rectangular plate</i> 34,5x23,5 cm pack: 6		
			<b>*34.60230</b> CC-PBK32 κούπα χωρίς χέρι <i>chip cup</i> , 32 cl pack: 6		





## Terra porcelain - Rustic copper

	<b>*34.60220</b> CP-PRC19 πίατο ρηχό coupe <i>coupe plate</i> 19 cm pack: 6		<b>*34.60180</b> CB-PRC20 πίατο βαθύ <i>deep plate</i> 20 cm pack: 6		<b>*34.60281</b> MUG-PRC32 κούπα με χέρι <i>mug, 32 cl</i> pack: 6
	<b>*34.60221</b> CP-PRC24 πίατο ρηχό coupe <i>coupe plate</i> 24 cm pack: 6		<b>*34.60198</b> CB-PRC23 πίατο βαθύ <i>deep plate</i> 23 cm pack: 6		<b>*34.60278</b> BW-PRC11 μπολ   <i>round bowl</i> 11,5 cm pack: 6
	<b>*34.60197</b> CP-PRC27 πίατο ρηχό coupe <i>coupe plate</i> 27,5 cm pack: 6		<b>*34.60222</b> CB-PRC27 πίατο βαθύ <i>deep plate</i> 27,5 cm pack: 6		<b>34.60279</b> BW-PRC11 μπολ   <i>round bowl</i> 12,5 cm pack: 6
	<b>*34.60219</b> PR-PRC18 πίατο ρηχό flat <i>plate flat</i> 18 cm pack: 6		<b>*34.60177</b> RP-PRC24 πίατο παραλλ/μο <i>rectangular plate</i> 24x16,5 cm pack: 12		<b>*34.60282</b> RAM-PRC2 ραμικέν   <i>ramekin</i> 7 cl   2,5 oz pack: 12
	<b>*34.60195</b> PR-PRC21 πίατο raised <i>raised plate</i> 21 cm pack: 6		<b>*34.60178</b> RP-PRC29 πίατο παραλλ/μο <i>rectangular plate</i> 29x19,5 cm pack: 6		<b>*34.60223</b> RAM-PRC4 ραμικέν   <i>ramekin</i> 13 cl   4,5 oz pack: 12
	<b>*34.60196</b> PR-PRC26 πίατο raised <i>raised plate</i> 26 cm pack: 6		<b>*34.60179</b> RP-PRC34 πίατο παραλλ/μο <i>rectangular plate</i> 34,5x23,5 cm pack: 6		<b>*34.60233</b> CC-PRC32 κούπα χωρίς χέρι <i>chip cup, 32 cl</i> pack: 6





## Terra porcelain - Rose

	34.60235 πίατο ρηχό coupe <i>coupe plate</i> 19 cm pack: 6		34.60244 πίατο βαθύ <i>deep plate</i> 20 cm   5,3 cm pack: 6		*34.60248 κούπα με χέρι <i>mug</i> , 32cl pack: 6
	34.60236 πίατο ρηχό coupe <i>coupe plate</i> 24 cm pack: 6		34.60245 πίατο βαθύ <i>deep plate</i> 23 cm   6 cm pack: 6		*34.60249 μπολ   <i>round bowl</i> 11,5 cm pack: 6
	34.60237 πίατο ρηχό coupe <i>coupe plate</i> 27,5 cm pack: 6		34.60246 πίατο βαθύ <i>deep plate</i> 27,5 cm   6,5 cm pack: 6		34.60250 μπολ   <i>round bowl</i> 12,5 cm pack: 6
	34.60241 πίατο ρηχό flat <i>plate flat</i> 18 cm   2,6 cm pack: 6		*34.60238 πίατο παραλ/μο <i>rectangular plate</i> 24x16,5 cm pack: 12		34.60251 ραμκέν   <i>ramekin</i> 7cl pack: 12
	34.60242 πίατο raised <i>raised plate</i> 21 cm   2,9 cm pack: 6		34.60239 πίατο παραλ/μο <i>rectangular plate</i> 29x19,5 cm pack: 6		*34.60252 ραμκέν   <i>ramekin</i> 13 cl pack: 12
	34.60243 πίατο raised <i>raised plate</i> 26 cm   3,3 cm pack: 6		*34.60240 πίατο παραλ/μο <i>rectangular plate</i> 34,5x23,5 cm pack: 6		*34.60247 κούπα χωρίς χέρι <i>chip cup</i> , 32 cl pack: 6

















## Terra porcelain - Aqua blue

	<b>34.60225</b> CP-PBL19 πίατο ρηχό coupe <i>coupe plate</i> 19 cm pack: 6		<b>34.60184</b> CB-PBL20 πίατο βαθύ <i>deep plate</i> 20 cm pack: 6		<b>*34.60280</b> MUG-PBL κούπα με χέρι <i>mug</i> , 32 cl pack: 6
	<b>34.60226</b> CP-PBL24 πίατο ρηχό coupe <i>coupe plate</i> 24 cm pack: 6		<b>34.60201</b> CB-PBL23 πίατο βαθύ <i>deep plate</i> 23 cm pack: 6		<b>*34.60276</b> BW-PBL11 μπολ   <i>round bowl</i> 11,5 cm pack: 6
	<b>34.60227</b> CP-PBL27 πίατο ρηχό coupe <i>coupe plate</i> 27,5 cm pack: 6		<b>34.60228</b> CB-PBL27 πίατο βαθύ <i>deep plate</i> 27,5 cm pack: 6		<b>34.60277</b> BW-PBL11 μπολ   <i>round bowl</i> 12,5 cm pack: 6
	<b>34.60224</b> PR-PBL18 πίατο ρηχό flat <i>plate flat</i> 18 cm pack: 6		<b>*34.60181</b> RP-PBL24 πίατο παραλλ/μο <i>rectangular plate</i> 24x16,5 cm pack: 12		<b>34.60202</b> RAM-PBL2 ραμκέν   <i>ramekin</i> 7 cl   2,5 oz pack: 12
	<b>34.60199</b> PR-PBL21 πίατο raised <i>raised plate</i> 21 cm pack: 6		<b>34.60182</b> RP-PBL29 πίατο παραλλ/μο <i>rectangular plate</i> 29x19,5 cm pack: 6		<b>*34.60229</b> RAM-PBL4 ραμκέν   <i>ramekin</i> 13 cl   4,5 oz pack: 12
	<b>34.60200</b> PR-PBL26 πίατο raised <i>raised plate</i> 26 cm pack: 6		<b>*34.60183</b> RP-PBL34 πίατο παραλλ/μο <i>rectangular plate</i> 34,5x23,5 cm pack: 6		<b>*34.60232</b> CC-PBL32 κούπα χωρίς χέρι <i>chip cup</i> , 32 cl pack: 6











## Dolmen stoneware

	<b>30.80430</b> 6624020 πίατο ρηχό   <i>plate</i> 20 cm pack: 6/24		<b>30.80431</b> 6624019 μπολ οβάλ   <i>oval bowl</i> 19x11 cm   5 cm pack: 4/24		<b>*30.80435</b> 6624011 πίατο ρηχό   <i>plate</i> 11 cm pack: 6/72
	<b>30.80325</b> 6624027 πίατο ρηχό   <i>plate</i> 27 cm pack: 6/12		<b>30.80432</b> 6624211 μπολ   <i>bowl</i> 10x11 cm   5,5 cm pack: 6/48		<b>*30.80436</b> 6624013 κούπα   <i>cup</i> , 13 cl 7 cm   7 cm pack: 6/48
	<b>30.80326</b> 6624022 πίατο βαθύ   <i>deep plate</i> 21,5 cm   5 cm pack: 4/16		<b>30.80433</b> 6624111 μπολ   <i>bowl</i> 11 cm   3,5 cm pack: 6/48		<b>*30.80437</b> 6624025 κούπα   <i>cup</i> , 25 cl 8 cm   8 cm pack: 6/36
			<b>30.80434</b> 6624015 μπολ   <i>bowl</i> 15 cm   4,5 cm pack: 6/36		<b>*30.80438</b> 6624017 πιατάκι   <i>saucer</i> 16x17 cm pack: 6/36

















## Antoinette stoneware







	<b>30.80108</b> πίατο raised   <i>raised plate</i> 19 cm pack: 1/36		<b>30.80114</b> ταψί παραλ/μο <i>oven dish</i> 22x17x5cm pack: 1/18
	<b>30.80109</b> πίατο raised   <i>raised plate</i> 27 cm pack: 1/36		<b>30.80111</b> γάστρα μίνι με καπάκι <i>pot with lid</i> , 10 cm pack: 1/48
	<b>30.80110</b> πίατο raised   <i>raised plate</i> 30 cm pack: 1/12		<b>30.80113</b> μπολ   <i>bowl</i> , 15 cm pack: 1/24
			<b>30.80112</b> κούπα   <i>cup</i> 9,5 cm   9 cm pack: 1/36





stoneware *Splendido green*

	<b>*30.80465</b> 1156012 πίατο raised   <i>raised plate</i> 12 cm pack: 12/120		<b>30.80296</b> 1156027 πίατο raised   <i>raised plate</i> 26,5 cm pack: 3/24		<b>30.80329</b> 1156205 μπολ   <i>bowl</i> 17,5/20,5 cm   9,5 cm pack: 3/12
	<b>*30.80295</b> 1156017 πίατο raised   <i>raised plate</i> 17 cm pack: 4/48		<b>30.80297</b> 1156009 μπολ   <i>bowl</i> 8,5 cm   2,5 cm pack: 8/160		<b>30.80451</b> 1156011 μπολ   <i>bowl</i> 11 cm   4,3 cm pack: 6/96
	<b>*30.80293</b> 1156021 πίατο raised   <i>raised plate</i> 21 cm pack: 4/24		<b>30.80464</b> 1156010 μπολ   <i>bowl</i> 9,5 cm   5,5 cm pack: 6/72		<b>30.80342</b> 1156016 μπολ   <i>bowl</i> 16,5 cm   5,8 cm pack: 5/40
	<b>30.80294</b> 1156023 πίατο raised   <i>raised plate</i> 23,5 cm pack: 3/24		<b>30.80463</b> 1156105 μπολ   <i>bowl</i> 8,5/10,5 cm   4,8 cm pack: 12/72		<b>30.80298</b> 1156121 μπολ   <i>bowl</i> 21 cm   7 cm pack: 3/18
			<b>30.80328</b> 1156155 μπολ   <i>bowl</i> 13/15,5 cm   7,4 cm pack: 6/24		<b>*30.80453</b> 1156109 κούπα   <i>mug</i> 17 cl 6,5 cm   9,5 cm pack: 4/64

	<b>30.80314</b> 3339023 πίατο raised   <i>raised plate</i> 22,5 cm pack: 6/24		<b>30.80317</b> 3339020 μπολ   <i>bowl</i> 19,5 cm   5,4 cm pack: 6/12
	<b>30.80315</b> 3339028 πίατο raised   <i>raised plate</i> 28 cm pack: 4/12		<b>30.80469</b> 3339019 μπολ   <i>bowl</i> 19 cm   9,8 cm pack: 6
	<b>30.80316</b> 3339024 πίατο βαθύ raised <i>raised deep plate</i> 23,5 cm   4,1 cm pack: 3/12		<b>30.80462</b> 3339123 μπολ   <i>bowl</i> 23 cm   12 cm pack: 4

stoneware *Concrete*



# Sea Pearl stoneware



30.80336 9632022  
πίατο ρηχό | plate  
22 cm | 3 cm  
pack: 3/24



30.80322 9632027  
πίατο ρηχό | plate  
26,5 cm | 3,5 cm  
pack: 2/16



30.80355 9632419  
πίατο ρηχό | plate  
14 cm  
pack: 6/72



30.80443 9632409  
πίατο | plate  
8 cm  
pack: 12/144



30.80340 9632349  
μπολ οβάλ | oval bowl  
19x15 cm | 5 cm  
pack: 1/12



30.80319 9632359  
μπολ οβάλ | oval bowl  
24x21 cm | 5,5 cm  
pack: 1/12



30.80339 9632339  
μπολ οβάλ | oval bowl  
32x24 cm | 6 cm  
pack: 1/10



30.80324 9632319  
μπολ | bowl  
9,5 cm | 3 cm  
pack: 12/96



30.80338 9632329  
μπολ | bowl  
16 cm | 4,5 cm  
pack: 5/60



30.80461 9632609  
μπολ οβάλ | oval bowl  
10x5 cm | 3 cm  
pack: 12/144



30.80341 9632619  
μπολ οβάλ | oval bowl  
16x8 cm | 5 cm  
pack: 6/72



30.80545 9632019  
πίατο βαθύ | deep plate  
18,5 cm  
pack: 3/24



30.80337 9632122  
πίατο βαθύ | deep plate  
22 cm  
pack: 3/24



30.80335 9632016  
μπολ βαθύ κωνικό  
conical deep bowl  
15,5 cm | 5,3 cm  
pack: 5/60



30.80541 9632222  
μπολ βαθύ κωνικό  
conical deep bowl  
22 cm | 7 cm  
pack: 3/24



30.80460 9632025  
μπολ βαθύ κωνικό  
conical deep bowl  
24,5 cm | 7,3 cm  
pack: 2/12



30.80323 9632125  
πίατο ορθογώνιο  
rectangular plate  
24,5x12,5 | 3,5 cm  
pack: 6/36



30.80320 9632509  
πίατο ορθογώνιο  
rectangular plate  
33x12 cm | 3 cm  
pack: 3/30



30.80321 9632519  
πίατο ορθογώνιο  
rectangular plate  
51x13 cm | 3,5 cm  
pack: 2/20



30.80542 9632649  
πιατέλα τρίγωνη  
triangle platter  
20x10 cm | 2 cm  
pack: 5/40



30.80356 9632629  
πιατέλα τρίγωνη  
triangle platter  
40x23 cm | 3 cm  
pack: 2/10

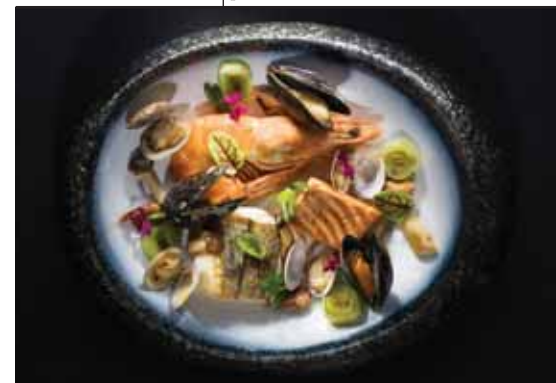











## stoneware *Basalt ocean green*













	<b>30.80641</b> 3945015 πίατο raised   <i>raised plate</i> 15 cm pack: 6		<b>30.80644</b> 3945024 πίατο βαθύ raised <i>raised deep plate</i> 24 cm   4 cm pack: 6		<b>30.80647</b> 3945006 μπολ   <i>bowl</i> 5,8 cm   4 cm (5 cl) pack: 6
	<b>30.80642</b> 3945021 πίατο raised   <i>raised plate</i> 21 cm pack: 6		<b>30.80645</b> 3945012 μπολ   <i>bowl</i> 11,5 cm   4,8 cm pack: 6		<b>30.80646</b> 3945007 κούπα   <i>mug</i> 6,5 cm   8,6 cm pack: 6
	<b>30.80643</b> 3945027 πίατο raised   <i>raised plate</i> 26 cm pack: 6		<b>30.80658</b> 3945010 μπολ   <i>bowl</i> 10 cm   3,7 cm pack: 6		<b>30.80648</b> 3945009 πίατο κούπας <i>mug plate</i> 9 cm pack: 12



## stoneware *Basalt fresh mint*













	<b>30.80649</b> 7428015 πίατο raised   <i>raised plate</i> 15 cm pack: 6		<b>30.80651</b> 7428024 πίατο βαθύ raised <i>raised deep plate</i> 24 cm   4 cm pack: 6		<b>30.80655</b> 7428006 μπολ   <i>bowl</i> 5,8 cm   4 cm (5 cl) pack: 6
	<b>30.80654</b> 7428021 πίατο raised   <i>raised plate</i> 21 cm pack: 6		<b>30.80653</b> 7428012 μπολ   <i>bowl</i> 11,5 cm   4,8 cm pack: 6		<b>30.80650</b> 7428007 κούπα   <i>mug</i> 6,5 cm   8,6 cm pack: 6
	<b>30.80656</b> 7428027 πίατο raised   <i>raised plate</i> 26 cm pack: 6		<b>30.80652</b> 7428010 μπολ   <i>bowl</i> 10 cm   3,7 cm pack: 6		<b>30.80657</b> 7428009 πίατο κούπας <i>mug plate</i> 9 cm pack: 12

## Grey πορσελάνη











	<p>πίατο coupe   <i>coupe plate</i></p> <p>53.50001 21 cm pack: 12</p> <p>53.50002 23 cm pack: 12</p>		<p>53.50006 πίατο βαθύ coupe <i>deep coupe plate</i> 21 cm pack: 12</p>		<p>53.50060 μπολ   <i>bowl</i>, 14 cm pack: 24</p> <p>53.50065 μπολ   <i>bowl</i>, 17 cm pack: 12</p>
	<p>53.50003 25 cm pack: 12</p> <p>53.50004 27 cm pack: 12</p> <p>53.50005 30 cm pack: 6</p>		<p>πατέλα οβάλ <i>oval platter</i></p> <p>53.50007 14x24 cm   4 cm pack: 6</p>		<p>53.50057 joker, 6 cm pack: 24</p>
	<p>53.50010 πίατο pasta   <i>deep pasta</i> 26 cm pack: 6</p>		<p>53.50008 15x26 cm   4 cm pack: 6</p> <p>53.50009 17x29 cm   4 cm pack: 6</p>		<p>53.50051 φλιτζάνι με πιάτο 9 cl pack: 6</p>
			<p>πατέλα ορθογώνια <i>rectangular platter</i></p> <p>53.50033 20x30 cm   2 cm pack: 6</p>		<p>53.50052 φλιτζάνι με πιάτο 22,5 cl pack: 6</p>
					<p>53.50021 mug 30 cl pack: 24</p>



## Blue πορσελάνη











	<p>πίατο coupe   <i>coupe plate</i></p> <p>53.50011 21 cm pack: 12</p> <p>53.50012 23 cm pack: 12</p>		<p>53.50016 πίατο βαθύ coupe <i>deep coupe plate</i> 21 cm pack: 12</p>		<p>53.50061 μπολ   <i>bowl</i>, 14 cm pack: 24</p> <p>53.50066 μπολ   <i>bowl</i>, 17 cm pack: 12</p>
	<p>53.50013 25 cm pack: 12</p> <p>53.50014 27 cm pack: 12</p> <p>53.50015 30 cm pack: 6</p>		<p>πατέλα οβάλ <i>oval platter</i></p> <p>53.50017 14x24 cm   4 cm pack: 6</p>		<p>53.50058 joker, 6 cm pack: 24</p>
	<p>53.50020 πίατο pasta   <i>deep pasta</i> 26 cm pack: 6</p>		<p>53.50018 15x26 cm   4 cm pack: 6</p> <p>53.50019 17x29 cm   4 cm pack: 6</p>		<p>53.50053 φλιτζάνι με πιάτο 9 cl pack: 6</p>
			<p>πατέλα ορθογώνια <i>rectangular platter</i></p> <p>53.50034 20x30 cm   2 cm</p>		<p>53.50054 φλιτζάνι με πιάτο 22,5 cl pack: 6</p>
					<p>53.50022 mug 30 cl pack: 24</p>

## πορσελάνη *Kaia*











	<p>πίατο coupe   <i>coupe plate</i></p> <p>53.50036 21 cm pack: 12</p> <p>53.50037 23 cm pack: 12</p>		<p>53.50041 πίατο βαθύ coupe <i>deep coupe plate</i> 21 cm pack: 12</p>		<p>53.50048 μπολ   <i>bowl</i>, 14 cm pack: 24</p> <p>53.50063 μπολ   <i>bowl</i>, 17 cm pack: 12</p>
	<p>53.50038 25 cm pack: 12</p> <p>53.50039 27 cm pack: 12</p> <p>53.50040 30 cm pack: 6</p>		<p>53.50044 πιπέλα οβάλ <i>oval platter</i> 53.50043 14x24 cm   4 cm pack: 6</p>		<p>53.50047 joker, 6 cm pack: 24</p>
	<p>53.50042 πίατο pasta   <i>deep pasta</i> 26 cm pack: 6</p>		<p>53.50044 15x26 cm   4 cm pack: 6</p> <p>53.50045 17x29 cm   4 cm pack: 6</p>		<p>53.50049 φλιτζάνι με πιάτο 9 cl pack: 6</p>
			<p>53.50046 πιπέλα ορθογώνια <i>rectangular platter</i> 53.50046 20x30 cm   2 cm pack: 6</p>		<p>53.50050 φλιτζάνι με πιάτο 22,5 cl pack: 6</p>













## πορσελάνη *Athena*

	<p>πίατο coupe   <i>coupe plate</i></p> <p>53.50023 21 cm pack: 12</p> <p>53.50024 23 cm pack: 12</p>		<p>53.50028 πίατο βαθύ coupe <i>deep coupe plate</i> 21 cm pack: 12</p>		<p>53.50062 μπολ   <i>bowl</i>, 14 cm pack: 24</p> <p>53.50064 μπολ   <i>bowl</i>, 17 cm pack: 12</p>
	<p>53.50025 25 cm pack: 12</p> <p>53.50026 27 cm pack: 12</p> <p>53.500427 30 cm pack: 6</p>		<p>53.500430 πιπέλα οβάλ <i>oval platter</i> 53.50029 14x24 cm   4 cm pack: 6</p>		<p>53.50059 joker, 6 cm pack: 24</p>
	<p>53.50032 πίατο pasta   <i>deep pasta</i> 26 cm pack: 6</p>		<p>53.50031 15x26 cm   4 cm pack: 6</p> <p>53.50031 17x29 cm   4 cm pack: 6</p>		<p>53.50055 φλιτζάνι με πιάτο 9 cl pack: 6</p>
			<p>53.500435 πιπέλα ορθογώνια <i>rectangular platter</i> 53.500435 20x30 cm   2 cm</p>		<p>53.50056 φλιτζάνι με πιάτο 22,5 cl pack: 6</p>

## Tivoli blue πορσελάνη

	<p>πίατο coupe   <i>coupe plate</i></p> <p>53.50078 21 cm pack: 12</p> <p>53.50079 25 cm pack: 12</p>		<p>53.50082 πίατο βαθύ coupe <i>deep coupe plate</i></p> <p>21 cm pack: 12</p>		<p>53.50088 μπολ   <i>bowl</i>, 14 cm pack: 24</p> <p>53.50089 μπολ   <i>bowl</i>, 17 cm pack: 12</p>
	<p>53.50080 27 cm pack: 12</p> <p>53.50081 30 cm pack: 6</p>		<p>53.50084 πιπέλα οβάλ <i>oval platter</i></p> <p>14x24 cm   4 cm pack: 6</p>		<p>53.50120 joker 6 cm pack: 24</p>
	<p>53.50083 πίατο pasta   <i>deep pasta</i></p> <p>26 cm pack: 6</p>		<p>53.50085 15x26 cm   4 cm pack: 6</p> <p>53.50086 17x29 cm   4 cm pack: 6</p>		<p>53.50090 φλιτζάνι με πιάτο 9 cl pack: 6</p>
			<p>53.50087 πιπέλα ορθογώνια <i>rectangular platter</i></p> <p>20x30 cm   2 cm pack: 6</p>		<p>53.50091 φλιτζάνι με πιάτο 22,5 cl pack: 6</p>















## Tivoli grey πορσελάνη

	<p>πίατο coupe   <i>coupe plate</i></p> <p>53.50092 21 cm pack: 12</p> <p>53.50093 25 cm pack: 12</p>		<p>53.50096 πίατο βαθύ coupe <i>deep coupe plate</i></p> <p>21 cm pack: 12</p>		<p>53.50102 μπολ   <i>bowl</i>, 14 cm pack: 24</p> <p>53.50103 μπολ   <i>bowl</i>, 17 cm pack: 12</p>
	<p>53.50094 27 cm pack: 12</p> <p>53.50095 30 cm pack: 6</p>		<p>53.50098 πιπέλα οβάλ <i>oval platter</i></p> <p>14x24 cm   4 cm pack: 6</p>		<p>53.50121 joker 6 cm pack: 24</p>
	<p>53.50097 πίατο pasta   <i>deep pasta</i></p> <p>26 cm pack: 6</p>		<p>53.50099 15x26 cm   4 cm pack: 6</p> <p>53.50100 17x29 cm   4 cm pack: 6</p>		<p>53.50104 φλιτζάνι με πιάτο 9 cl pack: 6</p>
			<p>53.50101 πιπέλα ορθογώνια <i>rectangular platter</i></p> <p>20x30 cm   2 cm pack: 6</p>		<p>53.50105 φλιτζάνι με πιάτο 22,5 cl pack: 6</p>

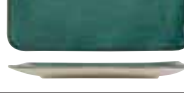

νέο  
πρόϊον









ποροεδάνη *Tivoli green*

	<p>πίατο coupe   <i>coupe plate</i> 53.50106 21 cm pack: 12</p>		<p>53.50110 πίατο βαθύ coupe <i>deep coupe plate</i> 21 cm pack: 12</p>		<p>53.50116 μπολ   <i>bowl</i>, 14 cm pack: 24</p>
	<p>53.50107 25 cm pack: 12</p>		<p>53.50112 14x24 cm   4 cm pack: 6</p>		<p>53.50122 joker 6 cm pack: 24</p>
	<p>53.50108 27 cm pack: 12</p>		<p>53.50113 15x26 cm   4 cm pack: 6</p>		<p>53.50118 φλιτζάνι με πιάτο 9 cl pack: 6</p>
	<p>53.50109 30 cm pack: 6</p>		<p>53.50114 17x29 cm   4 cm pack: 6</p>		<p>53.50119 φλιτζάνι με πιάτο 22,5 cl pack: 6</p>
	<p>53.50111 πίατο pasta   <i>deep pasta</i> 26 cm pack: 6</p>		<p>53.50115 20x30 cm   2 cm pack: 6</p>		













## «Ebro» οπαδίνα

	<b>00.52333</b> πίατο φρούτου   <i>plate</i> 20 cm pack: 6		<b>00.52338</b> πατέλα στρογγυλή βαθιά   <i>deep round platter</i> , 32 cm pack: 6
	<b>00.52337</b> πίατο ρηχό   <i>plate</i> 26 cm pack: 6		<b>00.52335</b> πατέλα οβάλ <i>oval platter</i> , 22 cm pack: 6
	<b>00.52334</b> πίατο βαθύ   <i>deep plate</i> 24 cm pack: 6		<b>00.52336</b> πατέλα οβάλ <i>oval platter</i> , 36 cm pack: 6
	<b>00.52339</b> πατέλα στρογγυλή <i>platter round</i> 32 cm pack: 6		<b>00.52331</b> μπολ   <i>bowl</i> , 13 cm pack: 6









## «Toledo» οπαδίνα

	<b>00.52100</b> πίατο   <i>plate</i> , 20 cm pack: 6/36		<b>00.44122</b> μπολ   <i>bowl</i> , 23 cm pack: 3/12
	<b>00.52102</b> πίατο   <i>plate</i> , 25 cm pack: 6/36		<b>00.56120</b> πατέλα οβάλ <i>oval platter</i> , 22x14,2 cm pack: 6/324
	<b>00.52101</b> πίατο βαθύ   <i>deep plate</i> 24 cm pack: 6/36		<b>00.56121</b> πατέλα οβάλ <i>oval platter</i> , 30x22,5 cm pack: 6/24
	<b>00.44120</b> μπολ   <i>bowl</i> , 17 cm pack: 6/24		<b>00.56122</b> πατέλα οβάλ <i>oval platter</i> 36x27 cm pack: 6/12
	<b>00.44123</b> μπολ   <i>bowl</i> , 11 cm pack: 6/36		



## «Parma» οπαδίνα

	<b>00.52367</b> 880 πίατο ρηχό   <i>plate</i> 20x20 cm pack: 6/24		<b>00.52366</b> πίατο βαθύ   <i>deep plate</i> 23x23 cm pack: 6/24
	<b>00.52365</b> 860 πίατο ρηχό   <i>plate</i> 27x27 cm pack: 6/24		<b>00.52371</b> πατέλα παραλληλ <i>rectangular platter</i> 24x34 cm pack: 6/12
	<b>00.52364</b> πίατο ρηχό   <i>plate</i> 31x31 cm pack: 6/12		<b>00.44192</b> μπολ   <i>bowl</i> , 14x14 cm pack: 6/24
			<b>00.44193</b> μπολ   <i>bowl</i> , 25x25 cm pack: 6/12



## οπαδίνα «Grangusto»

	<b>00.56152</b> πίατο pasta <i>pasta plate</i> 29,5 cm pack: 6
	<b>00.56157</b> πίατο risotto <i>risotto plate</i> 27 cm pack: 6
	<b>00.56156</b> πίατο pizza <i>pizza plate</i> 33,5 cm pack: 6
	<b>00.56158</b> πίατο steak <i>steak plate</i> 31,7x26,2 cm pack: 6
	<b>00.56154</b> πιατέλα οβάλ   <i>platter</i> 35x26,8 cm pack: 6



	<b>00.56151</b> πίατο BBQ <i>BBQ plate</i> 33x24 cm pack: 6		<b>00.56153</b> πιατέλα   <i>platter</i> 21,7x16,3 cm pack: 6
	<b>00.56155</b> πιατέλα   <i>platter</i> 28x21 cm pack: 6		<b>00.56150</b> σαλατιέρα   <i>salad bowl</i> 19 cm pack: 6

## οπαδίνα «Coconut»

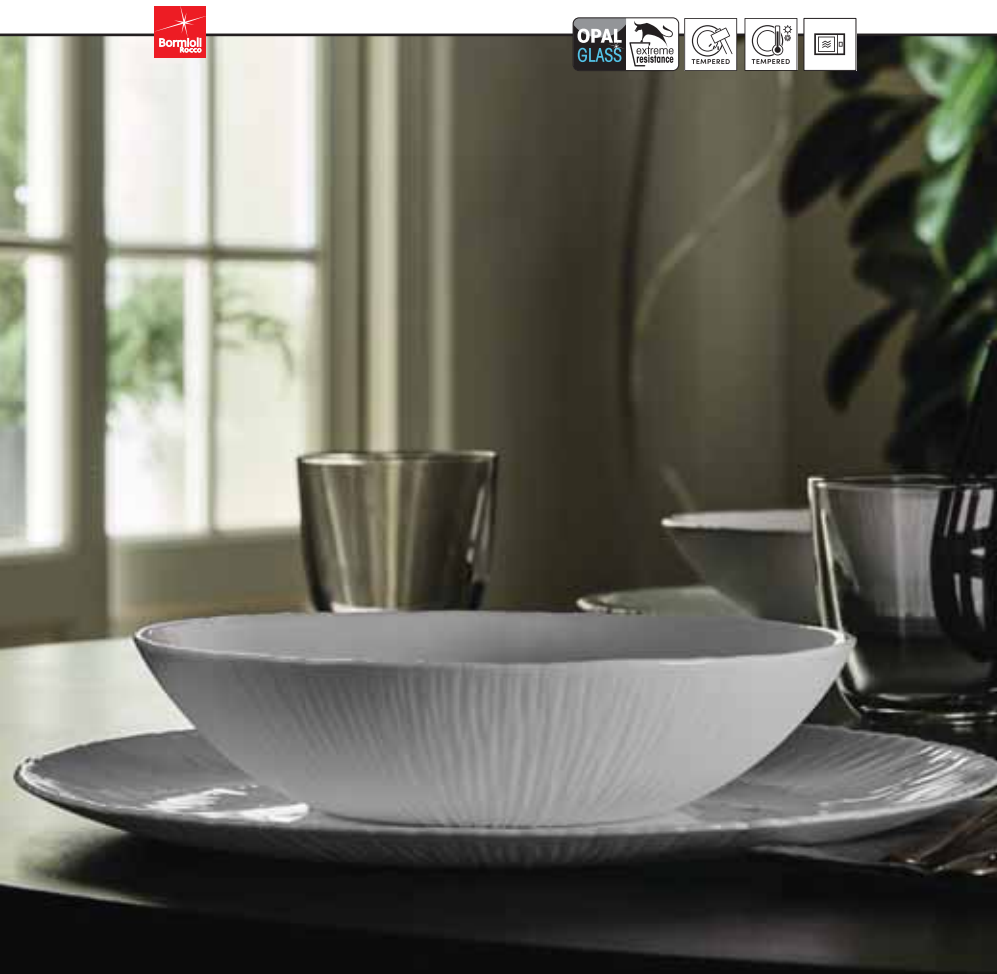

	<b>00.52351</b> πίατο φαγητού   <i>plate</i> 21 cm pack: 6
	<b>00.52353</b> πίατο φαγητού   <i>plate</i> 27 cm pack: 6
	<b>00.52352</b> πίατο βαθύ <i>deep plate</i> , 20 cm pack: 6
	<b>00.52350</b> σαλατιέρα   <i>bowl</i> 23 cm pack: 6

<i>Spiegelau</i> .....	126-129
<i>Nachtmann</i> .....	130
<i>ποτήρια Vintage</i> .....	131
<i>Luigi Bormioli</i> .....	132-145
<i>Bormioli Rocco</i> .....	146-159
<i>Onis</i> .....	160-170
<i>Ocean</i> .....	171
<i>Borgonovo</i> .....	172-177
<i>ποτήρια παγωτού / επιδορπίων / milkshake / smoothies</i> .....	178-179



# *ποτήρια - glassware*



Για πάνω από 500 χρόνια, η Spiegelau δημιουργεί υψηλής ποιότητας ποτήρια που είναι εντυπωσιακά, εξισορροπούν τέλεια την αναλογία, τη μορφή και τη λειτουργία τους. Η Spiegelau συνδυάζει όλα όσα ζητά ο επαγγελματίας στην εστίαση, σχέδια που αναδεικνύουν και τονίζουν το χρώμα και τη γεύση του κρασιού, ακοδουθύνιας διεθνείς τάσεις στο κύριο των ποτών. Μένοντας πάντα πιστή στο πνεύμα της Βαβαρικής δεξιοτεχνίας, η Spiegelau υιοθετεί την πιο πρόσφατη τεχνολογία για να διασφαλίσει ότι τα ποτήρια της είναι αξιόπιστα και ανθεκτικά.

For more than 500 years, Spiegelau creates high quality glasses that are striking yet simple, perfectly balancing proportion, form, and function. Spiegelau combines everything that professionals require, designs that highlight and emphasize the color and flavor of wine, following international trends in the beverage industry. Staying faithful to the spirit of Bavarian artisan craftsmanship, Spiegelau adopts the latest, most innovative technology to make sure glasses are very reliable and durable.



## Festival





	28.81223 402 80 00 Burgundy 64 cl 10,1 cm   21,4 cm pack: 12		28.81225 402 80 02 white wine 35,2 cl 8,4 cm   19,1 cm pack: 12		28.81054 402 80 12 longdrink 40 cl 6,8 cm   15,6 cm pack: 12
	28.81040 402 80 35 bordeaux 50 cl 8,8 cm   21,4 cm pack: 12		28.81074 402 80 03 white wine 30,4 cl 7,8 cm   18,4 cm pack: 12		28.81268 402 80 16 tumbler 32 cl 8,4 cm   8,5 cm pack: 12
	28.81041 402 80 32 white wine 38 cl 8,1 cm   20,3 cm pack: 12		28.81061 402 80 07 champagne 17 cl 5,3 cm   22,4 cm pack: 12		
	28.81042 402 80 01 red wine / water 40 cl 8,8 cm   19,8 cm pack: 12		28.81076 402 82 35 bordeaux with calibration marks at 20 cl 50 cl 8,8 cm   21,4 cm pack: 12		

28.81052 000 01 49  
πετσέτα γαλιόματος  
polishing cloth  
64x50 cm  
pack: 20



## Style



	<p><b>28.81114</b> 467 80 00  <b>Burgundy</b>          64 cl          10,7 cm   22,5 cm          pack: 12</p>		<p><b>28.81237</b> 467 80 02  <b>white wine</b>          44 cl          8,5 cm   22,2 cm          pack: 12</p>
	<p><b>28.81236</b> 467 80 01  <b>red wine</b>          63 cl          9,6 cm   22,5 cm          pack: 12</p>		<p><b>28.81115</b> 467 80 07  <b>flute</b>          24 cl          6 cm   22,5 cm          pack: 12</p>

## Lifestyle

	<p><b>28.81231</b> 445 80 01  <b>red wine</b>          63 cl          9,6 cm   22,5 cm          pack: 12</p>
	<p><b>28.81232</b> 445 80 02  <b>white wine</b>          44 cl          8,5 cm   22,2 cm          pack: 12</p>
	<p><b>28.81235</b> 445 80 29  <b>champagne</b>          31 cl          7,5 cm   22,3 cm          pack: 12</p>
	<p><b>28.81233</b> 445 80 09  <b>longdrink</b>          51 cl          8,3 cm   13 cm          pack: 12</p>
	<p><b>28.81234</b> 445 80 15  <b>tumbler</b>          34 cl          8,3 cm   9 cm          pack: 12</p>



# Winelovers - Authentis casual



28.81032 409 80 35  
bordeaux  
58 cl  
9,2 cm | 22,6 cm  
pack: 12



28.81033 409 80 01  
red wine  
4,6 cl  
8,6 cm | 21,7 cm  
pack: 12



28.81034 409 80 02  
white wine  
38 cl  
8 cm | 20,9 cm  
pack: 12



28.81035 409 80 07  
champagne  
19 cl  
5,3 cm | 21,9 cm  
pack: 12



28.81001 480 80 35  
tumbler XXL  
63 cl  
9,6 cm | 12,9 cm  
pack: 12



28.81002 480 80 01  
tumbler L  
46 cl  
8,9 cm | 11,2 cm  
pack: 12



28.81000 480 80 00  
tumbler XL  
62,5 cl  
10,3 cm | 11,9 cm  
pack: 12



28.81003 480 80 02  
tumbler M  
42 cl  
8,5 cm | 10,9 cm  
pack: 12

## Allround



28.81267 429 80 31  
wine  
53,5 cl  
8,9 cm | 23,5 cm  
pack: 12



28.81266 429 80 32  
wine  
43 cl  
8,3 cm | 22,2 cm  
pack: 12



## blind tasting



28.81097 440 37 31  
blind tasting  
32 cl  
7,7 cm | 18,6 cm  
pack: 12











## Bar collection

	28.81226 471 80 25 champagne coupe 25 cl 11,2 cm   16,8 cm pack: 12
	28.81227 400 80 33 margarita 28 cl 12,2 cm   15,4 cm pack: 12
	28.81228 451 80 25 martini 19,5 cl 11,7 cm   17,5 cm pack: 12
	28.81230 439 80 39 gin & tonik 63 cl 10,6 cm   19,5 cm pack: 12
	28.81082 407 80 18 brandy 45 cl 9,7 cm   13,7 cm pack: 12

	28.81229 409 80 24 water / beer 40 cl 7,7 cm   16,2 cm pack: 12		28.81075 402 80 31 tasting 28,5 cl 7,4 cm   19,3 cm pack: 12
---	---	---	--

## Perfect serve collection

	28.81016 450 80 17 rocks 27 cl 8,2 cm   8,1 cm pack: 12		28.81224 450 80 06 nick & nora 15 cl 7,2 cm   14 cm pack: 12
	28.81017 450 80 16 d.o.f. 36,8 cl 8,6 cm   10 cm pack: 12		28.81022 450 80 08 coupe 23,5 cl 9,1 cm   14 cm pack: 12
	28.81019 450 80 19 longdrink 35 cl 7,1 cm   15 cm pack: 12		28.81023 450 80 25 coupe 16,5 cl 10,3 cm   14 cm pack: 12
	28.81027 450 80 20 shot 5,5 cl 4 cm   9 cm pack: 12		







# Nachtmann

FINE BAVARIAN CRYSTAL

Τα σχεδόν 180 χρόνια εμπειρίας και δεξιοτήτων καθώς και η παράδοση έχουν οδηγήσει την Nachtmann στη δημιουργία υψηλής ποιότητας προϊόντων. Εκπροσωπώντας το καλύτερο του «made in Germany», αντανακλά την διαρκή δέσμευσή της να φέρνει ποδιέδεια και δάμψη στην κάθε σημαντική ανθρώπινη στιγμή.

Driven by the experience and craftsmanship of 180 years, Nachtmann produces glasses following high quality standards. Proud for "Made in Germany" trademark, Nachtmann is committed to bring luxury and brilliance in every event. Noblesse & Bossa Nova collections are present in many Restaurants and Hotels.



## Bossa Nova

	28.80009 92055 longdrink, 39,5 cl 8,1 cm   15 cm pack: 12
	28.80010 92054 d.o.f., 33 cl 9 cm   10 cm pack: 12
	28.80018 103039 old fashion, 25,2 cl 8,2 cm   8,9 cm pack: 12

## Highland

	28.80006 96092 d.o.f., «Diamond» 34,5 cl 8,3 cm   10,2 cm pack: 12
	28.80005 96089 d.o.f., «Cross» 34,5 cl 8,3 cm   10,2 cm pack: 12
	28.80007 96091 d.o.f., «Square» 34,5 cl 8,3 cm   10,2 cm pack: 12

## Noblesse

	28.80001 91703 hi-ball, 37,5 cl 7,6 cm   14,9 cm pack: 12
	28.80002 91710 d.o.f., 29,5 cl 8,5 cm   10 cm pack: 12
	28.80024 98856 old fashion, 24,5 cl 8 cm   8,4 cm pack: 12





# Crystalline glasses



	<p><b>28.70016</b> 4854RB354 martini «Vintage Lace» 25 cl 9,8 cm   14,4 cm pack: 6/24</p>
	<p><b>28.70015</b> 4854RB351 Nick &amp; Nora Vintage Lace» 16 cl 7,4 cm   15 cm pack: 6/24</p>
	<p><b>28.70014</b> 4854RA354 martini, «Vintage Dots» 25 cl 9,8 cm   14,4 cm pack: 6/24</p>
	<p><b>28.70013</b> 4854RA351 Nick &amp; Nora, «Vintage Dots» 16 cl 7,4 cm   15 cm pack: 6/24</p>
	<p><b>28.70017</b> martini «Dots» 18 cl 11 cm   16 cm pack: 6/24</p>

	<p><b>28.70006</b> Martini/Saucer Champagne 25 cl 9,8 cm   14,4 cm pack: 6/24</p>
	<p><b>28.70005</b> 6515 0400 Nick &amp; Nora 16 cl 7,4 cm   15 cm pack: 6/24</p>
	<p><b>28.70007</b> Paris Saucer Champagne 26 cl 9,6 cm   13,1 cm pack: 6/24</p>
	<p><b>28.70018</b> Gin &amp; Tonic 63 cl 10,5 cm   20,3 cm pack: 6/24</p>



	<p><b>28.70021</b> Martini/Saucer Champagne 25 cl 9,8 cm   14,4 cm pack: 6/24</p>
	<p><b>28.70020</b> Nick &amp; Nora 16 cl 7,4 cm   15 cm pack: 6/24</p>
	<p><b>28.70022</b> Paris Saucer Champagne 26 cl 9,6 cm   13,1 cm pack: 6/24</p>

# Luigi Bormioli

Η Luigi Bormioli είναι ένα εξειδικευμένο εργοστάσιο κατασκευής υψηλής ποιότητας ποτηριών και επιτραπέζιων ειδών, μπουκαδιών αρωμάτων και αλκοολούχων ποτών με υψηλότερης ποιότητας κρύσταλλο που δεν περιέχει μόλυβδο.

Ακολουθώντας τα βήματα της διαχρονικής παράδοσης, η οικογένεια Bormioli συνεχίζει να υποστηρίζει την πάντα επίκαιρη και συναρπαστική πρόκληση που εμπνέεται από την τέχνη της κατασκευής γυαλιού.

Η Bormioli Luigi αριθμεί πάνω από 1.000 υπαλλήλους και παράγει 250 εκατομμύρια τεμάχια ετησίως σε είκοσι μηχανές μορφοποίησης κάτω από πέντε κλιβάνους που βρίσκονται σε δύο εγκαταστάσεις: την Πάρμα και την Abbiategrasso, κοντά στο Μιλάνο.

Τέλος, η ποιότητα των προϊόντων είναι πιστοποιημένα με ISO 9001



Luigi Bormioli is a specialized glass factory that manufactures high quality containers for perfume and alcoholic beverages, as well as tableware in superior crystal glass which does not contain lead.







Following in the steps of timeless tradition, the Bormioli family continues to uphold the ever topical and fascinating challenge inspired by the art of glass-making.

Bormioli Luigi numbers over 1,000 employees and produces 250 million pieces per year on twenty moulding machines under five furnaces located in two facilities: Parma and Abbiategrasso, near Milan.

Manufacturing capabilities and technological excellence allow us to cope with both enormous volumes and specific needs for smaller lots.



## Supremo

	<p>SON.hyx® TITANIUM Reinforced®</p> <p>08.00534 Burgundy, 65 cl 11 cm   24,5 cm pack: 6/12</p>		<p>08.00531 Chardonnay 35 cl 8,1 cm   22,1 cm pack: 6/24</p>
	<p>08.00533 Bordeux, 55 cl 9,5 cm   24,3 cm pack: 6/12</p>		<p>08.00530 champagne 24 cl 6,4 cm   25 cm pack: 6/24</p>
	<p>08.00532 Chianti / Pinot Grigio 45 cl 8,8 cm   23,3 cm pack: 6/24</p>		<p>08.00535 tumbler 45 cl 10 cm   9,8 cm pack: 6/24</p>



08.00756  
Barolo / Shiraz, 75 cl  
10,4 cm | 23,2 cm  
pack: 6/24

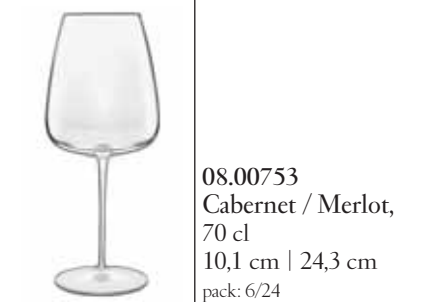

08.00753  
Cabernet / Merlot,  
70 cl  
10,1 cm | 24,3 cm  
pack: 6/24



08.00757  
Oaked chardonnay,  
65 cl  
10,1 cm | 21,8 cm  
pack: 6/24



08.00752  
Sangiovese / Chianti,  
55 cl  
9,3 cm | 22,7 cm  
pack: 6/24



08.00750  
Sauternes / Riesling,  
35 cl  
8 cm | 20,3 cm  
pack: 6/24

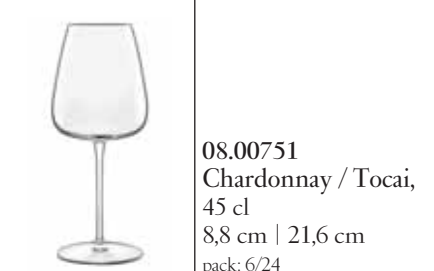

08.00751  
Chardonnay / Tocai,  
45 cl  
8,8 cm | 21,6 cm  
pack: 6/24

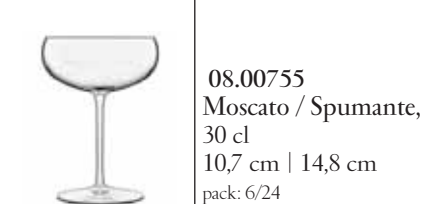

08.00755  
Moscato / Spumante,  
30 cl  
10,7 cm | 14,8 cm  
pack: 6/24



08.00754  
champagne / prosecco,  
40 cl  
7,8 cm | 24,5 cm  
pack: 6/24



08.00760  
flute, 21 cl  
6,7 cm | 21 cm  
pack: 6/24



08.00758  
stemless, 45 cl  
9,1 cm | 9,9 cm  
pack: 6/24



08.00759  
beverage, 57 cl  
8,6 cm | 14 cm  
pack: 4/24





	<p>08.00378 Chianti, 55 cl 9,1 cm   23,2 cm pack: 6/24</p>
---	--

	<p>08.00092 Riesling / Tocai, 44 cl 8,5 cm   22 cm pack: 6/24</p>
---	---





	<p>*08.00379 Sauvignon, 35 cl 7,9 cm   20,3 cm pack: 24</p>
---	---

	<p>08.00090 champagne / prosecco, 27 cl 6,88 cm   25,4 cm pack: 6/12</p>
---	--







	<p>08.00350 red wine, 45 cl 9,2 cm   22,1 cm pack: 6/24</p>
---	---

	<p>*08.00349 white wine, 35 cl 8,5 cm   20,5 cm pack: 24</p>
---	--

	<p>*08.00348 sparkling wine, 20 cl 6,4 cm   22,2 cm pack: 24</p>
---	--

	<p><b>SON.hyx®</b> TITANIUM Reinforced</p>	
<p>*08.00096 Barolo / Shiraz, 80 cl 11,5 cm   24,2 cm pack: 12</p>		<p>08.00327 Pinot noir / Rioja, 61 cl 10,5 cm   22 cm pack: 6/12</p>
	<p>*08.00197 Orvieto classico / Chardonnay, 70 cl 11,5 cm   21,7 cm pack: 12</p>	
	<p>08.00094 Carnbernet / Merlot 70 cl 10,1 cm   24,4 cm pack: 6/12</p>	



	<p><b>08.00091</b> cocktail, 30 cl 11,5 cm   16,4 cm pack: 6/12</p>		<p><b>08.00380</b> grappa, 8 cl 5 cm   16 cm pack: 6/24</p>		<p><b>08.00345</b> Pinot noir / Rioja 59 cl 10,5 cm   10,3 cm pack: 6/12</p>
	<p><b>*08.00381</b> martini, 26 cl 11,1 cm   18,5 cm pack: 12</p>		<p><b>08.00128</b> Cambernet / Merlot 67 cl 10,1 cm   12 cm pack: 6/12</p>		<p><b>08.00145</b> Riesling / Tocai 40 cl 8,47 cm   10,5 cm pack: 6/24</p>



**\*08.00240**  
Riserva, 76 cl  
9,9 cm | 24,8 cm  
pack: 12



**\*08.00241**  
Super 800, 80 cl  
12 cm | 23,5 cm  
pack: 12



**08.00230**  
Perlage, 17,5 cl  
5,5 cm | 25 cm  
pack: 6/24



**08.00237**  
Ricco, 59 cl  
9,1 cm | 23,8 cm  
pack: 6/24



**08.00238**  
Robusto, 66 cl  
10,6 cm | 22,6 cm  
pack: 6/12



**08.00229**  
Spirits snifter, 17 cl  
6,6 cm | 16,5 cm  
pack: 6/24



**08.00232**  
Fragrante, 38 cl  
8 cm | 22,3 cm  
pack: 6/24



**08.00228**  
grappa, 10,5 cl  
4,6 cm | 20,2 cm  
pack: 6/24



**08.00235**  
Maturo, 49 cl  
8,8 cm | 24,2 cm  
pack: 6/24



**08.00234**  
Smart tester, 40 cl  
8 cm | 22 cm  
pack: 6/24



**\*08.00233**  
Fresco, 38 cl  
8,1 cm | 22,8 cm  
pack: 24





**08.00151**  
Large, 59 cl  
9,6 cm | 25,3 cm  
pack: 6/12



**08.00150**  
Medium, 46 cl  
8,9 cm | 24 cm  
pack: 6/24



**08.00149**  
Small, 35 cl  
8,2 cm | 23 cm  
pack: 6/24



**08.00148**  
flute, 32 cl  
7,3 cm | 26 cm  
pack: 6/24



**08.00279**  
Magnifico 450, 45 cl  
8,6 cm | 26 cm  
pack: 6/24



**08.00280**  
Magnifico 650, 65 cl  
10,9 cm | 26 cm  
pack: 6/12



**08.00214**  
d.o.f., 50 cl  
9,4 cm | 10,4 cm  
pack: 6/24



**08.00255**  
XS liqueur, 7 cl  
4,6 cm | 17 cm  
pack: 6/24





08.00202  
Grandi vini, 57 cl  
9,1 cm | 22,5 cm  
pack: 6/24



08.00257  
goblet, 48 cl  
8,6 cm | 21,2 cm  
pack: 6/24



08.00201  
red wine, 36,5 cl  
8 cm | 19,4 cm  
pack: 6/24



08.00199  
white wine, 32,5 cl  
7,7 cm | 18,3 cm  
pack: 6/24



08.00256  
multipurpose, 42 cl  
8,3 cm | 16,3 cm  
pack: 6/24



08.00198  
flute, 23,5 cl  
5,9 cm | 23,8 cm  
pack: 6/24



08.00200  
sparkling water, 32 cl  
7,6 cm | 15 cm  
pack: 6/24







08.00370  
tonic water, 44,5 cl  
8,1 cm | 12,5 cm  
pack: 6/24



08.00258  
natural water, 40 cl  
8,8 cm | 9,9 cm  
pack: 6/24

	<b>08.00891</b> red wine, 40 cl 7,6 cm   22 cm pack: 4/24
	<b>08.00892</b> white wine, 28 cl 6,8 cm   20,6 cm pack: 4/24
	<b>08.00893</b> champagne, 21 cl 5,2 cm   23,5 cm pack: 4/24
	<b>08.00900</b> champagne/cocktail, 30 cl 10,5 cm   14,2 cm pack: 4/16
	<b>08.00894</b> beverage, 59 cl 7,8 cm   14,6 cm pack: 4/24
	<b>08.90002</b> beverage, 45 cl 7,2 cm   13,3 cm pack: 4/24
	<b>08.00895</b> d.o.f., 45 cl 8,4 cm   10 cm pack: 4/24
	<b>08.00901</b> d.o.f., 35 cl 7,8 cm   9,2 cm pack: 4/24



	<b>08.01022</b> cocktail coupe, 30 cl 10,5 cm   14,2 cm pack: 4/16		<b>08.01024</b> long drink, 45 cl 7,2 cm   13,3 cm pack: 4/24
	<b>08.01023</b> flute, 21 cl 7 cm   23,5 cm pack: 4/24		<b>08.01025</b> rocks, 35 cl 7,8 cm   9,2 cm pack: 4/24

Bach

SON.hyx® TITANIUM Reinforced



08.00462  
red wine, 40 cl  
7,7 cm | 22 cm  
pack: 4/24



08.00461  
white wine, 28 cl  
7 cm | 20,6 cm  
pack: 4/24



08.00460  
champagne, 21 cl  
5,3 cm | 23,5 cm  
pack: 4/24



08.00467  
martini, 26 cl  
11,3 cm | 18,5 cm  
pack: 4/16



08.00459  
gin, 60 cl  
10,7 cm | 20,1 cm  
pack: 4/16



08.00468  
retro fizz, 26 cl  
9,7 cm | 15,7 cm  
pack: 4/16



08.00469  
vintage cocktail, 25 cl  
7,5 cm | 19,5 cm  
pack: 4/24



08.00463  
beverage, 48 cl  
7,2 cm | 16 cm  
pack: 6/24



08.00464  
beverage, 36 cl  
6,4 cm | 15,5 cm  
pack: 6/24



08.00465  
d.o.f., 33,5 cl  
8,3 cm | 9,7 cm  
pack: 6/24





08.00466  
whiski, 25,5 cl  
7,5 cm | 9 cm  
pack: 6/24









## Top class

	<b>08.00266</b> beverage, 35 cl 6,7 cm   13 cm pack: 6/24
	<b>08.00267</b> all-purpose, 44 cl 7,9 cm   10,7 cm pack: 6/24
	<b>08.00265</b> water, 35 cl 7,9 cm   8,8 cm pack: 6/24







## (объём БАО) Veronese

	<b>SON.hyx®</b> <b>08.00326</b> beverage, 43 cl 7,9 cm   15,5 cm pack: 6/24
	<b>08.00366</b> hi-ball, 31 cl 6,9 cm   15 cm pack: 6/24
	<b>08.00030</b> d.o.f., 34,5 cl 9,1 cm   9,8 cm pack: 6/24
	<b>08.00294</b> whisky, 26 cl 8,3 cm   9,1 cm pack: 6/24













## Cognac











	<b>08.00400</b> «Napoleon», 72 cl 11,6 cm   16,6 cm pack: 6/12		<b>08.00402</b> «Napoleon», 39,5 cl 9,5 cm   13,6 cm pack: 6/24
	<b>08.00405</b> «Vinoteque», 46,5 cl 9,7 cm   12,7 cm pack: 6/24		<b>08.00403</b> «Napoleon», 23 cl 8 cm   11,6 cm pack: 6/24

# Roma 1960









SON.hyx® TITANIUM Reinforced

	<p><b>*08.00647</b> margarita, 39 cl 11,4 cm   18,4 cm pack: 6/12</p>		<p><b>*08.01019</b> gin glass, 80,5 cl 11,4 cm   23,5 cm pack: 6/12</p>		<p><b>*08.01018</b> rum, 45 cl 9,8 cm   9,2 cm pack: 6/24</p>
	<p><b>*08.00646</b> martini, 22 cl 10,4 cm   17,2 cm pack: 6/12</p>		<p><b>*08.01020</b> wine - cocktail, 55 cl 9 cm   22,5 cm pack: 6/24</p>		<p><b>*08.00645</b> hi-Ball, 48 cl 7,4 cm   15,1 cm pack: 6/24</p>
	<p><b>*08.01015</b> cocktail coupe, 30 cl 11,3 cm   15 cm pack: 6/12</p>		<p><b>*08.01017</b> flute, 24 cl 7 cm   24,4 cm pack: 6/24</p>		<p><b>*08.00644</b> beverage, 40 cl 7 cm   14,2 cm pack: 6/24</p>
	<p><b>*08.01016</b> fizz, 26 cl 9,6 cm   15,7 cm pack: 6/24</p>				<p><b>*08.00642</b> d.o.f., 38 cl 8,5 cm   9 cm pack: 6/24</p>
					<p><b>*08.00643</b> water, 30 cl 8 cm   8,4 cm pack: 6/24</p>



	<b>08.00626</b> 12346/01 d.o.f. «Textures» 38 cl 8,6 cm   9,6 cm pack: 6/24
	<b>08.00627</b> 12420/01 hi-ball «Textures» 48 cl 7,1 cm   15,7 cm pack: 6/12
	<b>08.00631</b> καράφα «Textures» 75 cl 9 cm   20,7 cm pack: 6
	<b>08.00628</b> 12344/01 d.o.f. «Elixir» 38 cl 8 cm   9,6 cm pack: 6/24
	<b>08.00629</b> 12419/01 hi-ball «Elixir» 48 cl 7,3 cm   15,7 cm pack: 6/12
	<b>08.00630</b> καράφα «Elixir» 75 cl 9 cm   20,7 cm pack: 6
	<b>08.00624</b> 12328/01 d.o.f. «Charme» 38 cl 8,5 cm   9,6 cm pack: 6/24
	<b>08.00625</b> 12418/01 hi-ball «Charme» 48 cl 7,4 cm   15,7 cm pack: 6/12









	<b>08.00623</b> 12464/01 gin & tonic, 80 cl 11,9 cm   20,5 cm pack: 6/12		<b>08.00621</b> 12459/01 martini, 21,5 cl 10,4 cm   17,2 cm pack: 6/24
	<b>08.00622</b> 12458/01 spritz, 57 cl 9,1 cm   22,5 cm pack: 6/12		<b>08.01021</b> 12876/01 schnapps, 7 cl 5,7 cm   13,8 cm pack: 6/24
	<b>08.00634</b> 12723/01 spirits, 23 cl 7,7 cm   11 cm pack: 6/12		<b>08.00620</b> 12460/01 cocktail, 22,5 cl 9,5 cm   14 cm pack: 6/24
	<b>08.00633</b> 12724/01 cognac, 46,5 cl 9,7 cm   12,7 cm pack: 6/12		<b>08.00635</b> 12671/01 Nick & Nora, 15 cl 6,9 cm   14,7 cm pack: 6/24



# Diamante

SON.hyx® TITANIUM Reinforced®

	<p>08.00639 gin, 65 cl 10,8 cm   22,2 cm pack: 4/8</p>		<p>08.00637 Chianti, 52 cl 9,4 cm   23,5 cm pack: 4/24</p>
	<p>08.00636 Riesling, 38 cl 8,5 cm   21,5 cm pack: 4/24</p>		<p>08.00638 prosecco, 22 cl 7 cm   23,6 cm pack: 4/24</p>
	<p>08.00641 beverage, 48 cl 7,2 cm   15,7 cm pack: 4/24</p>		<p>08.00640 d.o.f., 38 cl 8,3 cm   9,6 cm pack: 4/24</p>



## BEER TESTER



08.00595 C469  
beer tester, 42 cl  
8,9 cm | 20 cm  
pack: 6/24

## CIDER



08.00590 PM989  
cider, 50 cl  
9,5 cm | 14,6 cm  
pack: 6/24

- ✓Cirde/Sidro
- ✓Hard Cider
- ✓Fruit Cider
- ✓Scrupy
- ✓Pear/Perry

## IPA / WHITE IPA



08.00591 PM985  
Ipa / white Ipa, 54 cl  
8,8 cm | 18,4 cm  
pack: 6/24

- ✓Double / Imperial Ipa
- ✓American Ipa
- ✓English Ipa

## STOUT / PORTER



08.00592 PM986  
stout / porter, 60 cl  
9,5 cm | 17,8 cm  
pack: 6/24

- ✓Baltic Porter
- ✓Irish Dry Stout
- ✓Milk Stout
- ✓Oatmeal Stout
- ✓Oyster Stout
- ✓Bock

## PREMIUM SNIFFER



08.00597 C495  
Premium Snifter, 56 cl  
9,7 cm | 17,4 cm  
pack: 6/24

- ✓Belgian Style Beers,
- ✓Bocks ✓Dark Lagers,
- ✓Specialty & Hybrid
- ✓ Wild/Sour Beers

## PILSNER



08.00596 PM1020  
Pilsner, 54 cl  
7,7 cm | 20,4 cm  
pack: 2/12

- ✓American Pilsners,
- ✓Baltic Pilsners,
- ✓German Pilsners,
- ✓Czech Pilsners



SON.hyx® TITANIUM Reinforced

Birrateque

1. Ιδανική διάμετρος του χείλους ώστε να μεινύεται η ταχύτητα με την οποία η μπίρα διοχετεύεται στο στόμα, δίνοντας τον απαραίτητο χρόνο στους γευστικούς κάλυκες να αναγνωρίσουν όλα τα γευστικά στοιχεία καταδδήδως.
2. Φινίρισμα του χείλους με δέιζερ: Με 1,2 χιλ πάχος αποφεύγεται η ανατάραξη του υγρού και πετυχαίνει μια ευχάριστη αίσθηση στο στόμα.
3. Σχήμα καμινάδας για να εξισορροπούνται τα αρώματα.
4. Υπερκείμενος χώρος (θάλαμος αρωμάτων).
5. Σχήμα μπού με καμπύλες ειδικά για κάθε είδος μπίρας για να αιχμαδιωτίζει τα σωστά αρώματα.
6. Αφρός (χώρος στο πάνω μέρος): «μεταφορέας αρωμάτων» για να αποφεύγεται η οξείδωση της μπίρας χωρίς να μεταβάδδεται το επίπεδο της πικράδας.
7. Στενός κορμός: εύκοδο και ευχάριστο κράτημα και μεινύει τη μεταφορά θερμότητας από το χέρι στη μπίρα
8. Βάση: Σταθερή
9. Σύστημα εδέγχων αφρού: Ένας κύκλος χαλαγμένος με δέιζερ που βοηθάει να διατηρείται ένα έξοχο και επίμονο ρεύμα από φυσαδίδες ανατροφοδοπύντας το πάνω μέρος και παράδδηδα εδένθερύνοντας τα αρώματα.



## WHEAT / WEISS



08.00594 PM987  
wheat / weiss, 78 cl  
10,2 cm | 18,8 cm  
pack: 6/24

- ✓Dunkel
- ✓Weizen Doppelbock
- ✓Berliner Weisse
- ✓Gose
- ✓Lambic
- ✓Belgian Witbier

## SEASONAL/SAISON



08.00593 PM988  
seasonal / saison, 75 cl  
10,5 cm | 18,4 cm  
pack: 6/24

- ✓Krick
- ✓Framboise
- ✓Bière De Garde
- ✓Holiday Spiced Beers

Π Ο Τ Η Ρ Ι Α

145

Luigi's Pommiolo







το νέο brand  
από τον οίκο  
Bormioli Rocco

Σε συνεργασία με την Ιταδική δέσση Sommeliers (AIS) δημιουργούνται σειρές που απευθύνονται αποκλειστικά στα πιο διακεκριμένα εστιατόρια παγκοσμίως. Τεχνολογικά επιτεύγματα που συνδυάζουν την καθαρότητα του κρύσταλλου (Star Glass) και την τεχνολογία XTL, μονοκόμιο πόδι με αντοχή, κομμένο μπουθ στο χέιλος, κατανεμημένο πάχος και πέδημα με μέγιστη σταθερότητα.



*In collaboration with the Italian Sommeliers Club (AIS) series are being created which are exclusively dedicated to the most distinguished restaurants worldwide. Brant by Bormioli Rocco.*

## Tre Sensi



00.13179  
XL, 65 cl  
9,8 cm | 24,3 cm  
pack: 6/24



00.13176  
Large, 55 cl  
9,2 cm | 23,5 cm  
pack: 6/24



00.13177  
Medium, 43 cl  
8,5 cm | 22 cm  
pack: 6/24



00.13178  
Small, 30,5 cl  
7,7 cm | 20,4 cm  
pack: 6/24















00.13180  
d.o.f., 45 cl  
9,2 cm | 10,3 cm  
pack: 6/24









Premium





   <small>EXTRA RESISTANCE</small>					
	<p><b>00.13145</b> (No 6) Chardonay, 60 cl (set of 6) 9,5 cm   23,8 cm pack: 2</p>		<p><b>00.13150</b> (No 11) Sauvignon, 33 cl (set of 6) 7,8 cm   22 cm pack: 2</p>		<p><b>00.13157</b> Montepulciano, 55 cl (set of 6) 9,5 cm   23 cm pack: 4</p>
	<p><b>00.13141</b> (No 2) Chianti classico, 38 cl (set of 6) 8,1 cm   22,6 cm pack: 2</p>		<p><b>00.13143</b> (No 4) Barolo, 67,5 cl (set of 6) 10,8 cm   22,5 cm pack: 2</p>		<p><b>00.13156</b> Rose, 44 cl (set of 6) 8,7 cm   21,6 cm pack: 4</p>
	<p><b>00.13149</b> (No 10) Merlot, 47 cl (set of 6) 8,6 cm   23,3 cm pack: 2</p>		<p><b>00.13142</b> (No 3) champagne, 26 cl (set of 6) 7,8 cm   24,5 cm pack: 2</p>		<p><b>00.10674</b> degustazione, 21,5 cl 4,7 cm   15,5 cm pack: 6/24</p>
					<p><b>00.13153</b> sparkling water, 43 cl (set of 6) 8,5 cm   10,5 cm pack: 4</p>

## Spazio

	<p><b>00.10063</b>          XL, 64 cl          9,3 cm   22,5 cm          pack: 6</p>
	<p><b>00.10061</b>          large, 50 cl          9 cm   21,2 cm          pack: 6</p>
	<p><b>00.10062</b>          medium, 40 cl          8,2 cm   20 cm          pack: 6</p>
	<p><b>00.10069</b>          champagne coupe          30 cl          10,1 cm   16,5 cm          pack: 2</p>
	<p><b>00.10064</b>          flute, 21,5 cl          6,6 cm   21,2 cm          pack: 3</p>



## New Sara

	<p><b>00.11860</b>          bourgundy, 43 cl          6,9 cm   20,8 cm          pack: 12</p>		<p><b>00.11863</b>          wine, 25 cl          7,2 cm   18,3 cm          pack: 12</p>
	<p><b>00.11862</b>          water, 36 cl          6,2 cm   19,8 cm          pack: 12</p>		<p><b>00.11861</b>          flute, 17 cl          5,4 cm   19,6 cm          pack: 12</p>





## New Kalix



00.11877  
Goblet, 35 cl  
8,4 cm | 18,9 cm  
pack: 12



00.11881  
water, 27 cl  
7,7 cm | 18 cm  
pack: 12



00.11884  
flute, 17 cl  
5,8 cm | 19,6 cm  
pack: 12



## Aurum



00.13050  
Vino rosso, 52 cl  
9,3 cm | 22,5 cm  
pack: 6/12



00.13046  
Burgunder, 43 cl  
9 cm | 21,3 cm  
pack: 6/12



00.13049  
Vino bianco, 35 cl  
8,3 cm | 20,3 cm  
pack: 6/12



00.13047  
flute, 23 cl  
6,8 cm | 23,5 cm  
pack: 6/12



00.13051  
water, 36 cl  
8,3 cm | 9,5 cm  
pack: 6/12

## Fiore



00.11014  
Goblet, 32 cl  
8,5 cm | 19,7 cm  
pack: 12



00.11018  
schnaps, 5,5 cl  
5,6 cm | 14,5 cm  
pack: 12



00.11039  
water, 30 cl  
7,4 cm | 9,8 cm  
pack: 6

## Onyx



00.12792  
wine, 20 cl  
6,8 cm | 15,1 cm  
pack: 12

## Executive



00.10861  
water, 28 cl  
(set of 3)  
7,6 cm | 13,2 cm  
pack: 6/24



00.10862  
wine, 20,7 cl  
(set of 3)  
6,8 cm | 12 cm  
pack: 6/24



## Vino



00.10031  
red wine, 52,5 cl  
9,8 cm | 21,5 cm  
pack: 6



00.10033  
red wine, 52,5 cl  
με διαγράμμιση 0,15 lt  
9,8 cm | 21,5 cm  
pack: 6



00.10030  
white wine, 42,5 cl  
8,8 cm | 21,5 cm  
pack: 6



00.10032  
white wine, 42,5 cl  
με διαγράμμιση 0,15 lt  
8,8 cm | 21,5 cm  
pack: 6

# America '20s



**00.10096**  
gin tonik, 24 cl  
10,9 cm | 22,6 cm  
pack: 6



**00.10097**  
cocktail, 25 cl  
7,8 cm | 20,2 cm  
pack: 6



**00.10099**  
cocktail coupe, 23 cl  
9,8 cm | 15,7 cm  
pack: 4



**00.10098**  
martini, 25 cl  
10,8 cm | 18 cm  
pack: 4



**00.10081**  
fizz, 27,5 cl  
10,8 cm | 13,8 cm  
pack: 6



**00.10082**  
nick&nora, 14 cl  
7,6 cm | 15,9 cm  
pack: 6



**00.10086**  
cooler, 48 cl  
7,4 cm | 16,2 cm  
pack: 6



**00.10087**  
long drink, 40 cl  
6,8 cm | 15,8 cm  
pack: 6



**00.10088**  
rocks, 30 cl  
8,4 cm | 8,4 cm  
pack: 6



**00.10085**  
d.o.f., 38 cl  
8,8 cm | 9,2 cm  
pack: 6



**00.10089**  
shot, 8 cl  
4,5 cm | 8 cm  
pack: 6



**00.10090**  
mixing glass, 79 cl  
10,8 cm | 16 cm  
pack: 6



**00.10094**  
cooler  
sapphire blue, 48 cl  
7,4 cm | 16,2 cm  
pack: 6



**00.10092**  
d.o.f.  
sapphire blue, 38 cl  
8,8 cm | 9,2 cm  
pack: 6



**00.10095**  
cooler  
lilac rose, 48 cl  
7,4 cm | 16,2 cm  
pack: 6



**00.10093**  
d.o.f.  
lilac rose, 38 cl  
8,8 cm | 9,2 cm  
pack: 6



## Novecento art deco



**00.10068**  
Nick & Nora, 15,5 cl  
7,4 cm | 15,5 cm  
pack: 6



**00.10066**  
martini, 23,5 cl  
9,5 cm | 15,5 cm  
pack: 6



**00.10065**  
cocktail, 25 cl  
9,4 cm | 15,5 cm  
pack: 6



**00.10067**  
fizz, 22 cl  
9 cm | 12,4 cm  
pack: 6



## Novecento



**00.10073**  
Nick & Nora, 15,5 cl  
7,4 cm | 15,5 cm  
pack: 6



**00.10072**  
martini, 23,5 cl  
9,5 cm | 15,5 cm  
pack: 6



**00.10070**  
cocktail, 25 cl  
9,4 cm | 15,5 cm  
pack: 6



**00.10071**  
fizz, 22 cl  
9 cm | 12,4 cm  
pack: 6



**00.10060**  
champagne coupe  
«Spazio», 30 cl  
10,1 cm | 16,5 cm  
pack: 2

## Florian

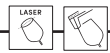

**00.14240**  
red wine - gin tonik  
53,5 cl  
9,2 cm | 22,1 cm  
pack: 6



**00.14241**  
white wine - spritz  
38 cl  
8,2 cm | 20,8 cm  
pack: 6



**00.14242**  
cocktail - whiskey sour  
24,5 cl  
7,2 cm | 19,8 cm  
pack: 6



**00.14243**  
champagne - martini  
24 cl  
9,7 cm | 16,4 cm  
pack: 6



**00.14244**  
prosecco - kir royal  
21 cl  
6,5 cm | 22 cm  
pack: 6



**00.14245**  
beverage - long island  
43 cl  
7,3 cm | 14,1 cm  
pack: 6



**00.14246**  
d.o.f. - negroni  
37,5 cl  
7,8 cm | 11,3 cm  
pack: 6



**00.14247**  
rocks - white russian  
30 cl  
7,3 cm | 10,4 cm  
pack: 6

## Florian lucent blue

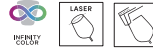

**00.14250**  
red wine - gin tonik  
53,5 cl  
9,2 cm | 22,1 cm  
pack: 6



**00.14251**  
white wine - spritz  
38 cl  
8,2 cm | 20,8 cm  
pack: 6



**VEO**  
VINO

**00.14254**  
prosecco - kir royal  
21 cl  
6,5 cm | 22 cm  
pack: 6



**00.14252**  
beverage - long island  
43 cl  
7,3 cm | 14,1 cm  
pack: 6



**00.14253**  
d.o.f. - negroni  
37,5 cl  
7,8 cm | 11,3 cm  
pack: 6





## Barshine



00.14260  
long drink  
38 cl  
8,3 cm | 12 cm  
pack: 6



00.14261  
d.o.f.  
39,5 cl  
9,1 cm | 10 cm  
pack: 6



00.14262  
rocks  
30,5 cl  
8,4 cm | 9,2 cm  
pack: 6



00.14263  
juice  
21 cl  
7,6 cm | 8,4 cm  
pack: 6



## Oxford bar



00.14230  
beverage  
39,5 cl  
8,2 cm | 14,3 cm  
pack: 6



00.14231  
d.o.f.  
37,4 cl  
8,9 cm | 10,4 cm  
pack: 6



00.14232  
rocks  
31,2 cl  
8,5 cm | 9,9 cm  
pack: 6



00.14233  
shot  
3,8 cl  
4,4 cm | 5,9 cm  
pack: 6



## Novecento



00.10075  
hi-ball, 40,5 cl  
8 cm | 13,5 cm  
pack: 6







00.10074  
d.o.f., 37 cl  
8,7 cm | 10,1 cm  
pack: 6







## Ypsilon

	<b>00.14093</b> long drink, 32 cl 7,7 cm   16 cm pack: 12		<b>00.14104</b> pre dinner, 25 cl 9,2 cm   10,7 cm pack: 12
	<b>00.14091</b> d.o.f., 33,5 cl 10,1 cm   11,7 cm pack: 12		<b>00.14094</b> after dinner, 15 cl 7,7 cm   9,5 cm pack: 6/24
			<b>00.14087</b> shot, 7 cl 5 cm   10,7 cm pack: 6/24







## Cassiopea



	<b>00.14138</b> cooler 48 cl 8 cm   14,7 cm pack: 6
	<b>00.14139</b> water 32 cl 8,6 cm   8,8 cm pack: 12





## Luna

	<b>00.12196</b> cooler, 44,5 cl 8,2 cm   14,5 cm pack: 12
	<b>00.12190</b> long drink, 34 cl 7,6 cm   13,7 cm pack: 12
	<b>00.12191</b> d.o.f., 34 cl 8,7 cm   10,8 cm pack: 12
	<b>00.12193</b> rocks, 26 cl 8 cm   9,7 cm pack: 12



## Sorgente

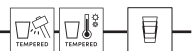

	<b>00.13493</b> cooler, 45 cl 7,2 cm   15,2 cm pack: 6
	<b>00.13494</b> d.o.f., 42 cl 8,3 cm   10,5 cm pack: 6
	<b>00.13487</b> liqueur, 7 cl (set of 3) 4,9 cm   7,4 cm pack: 24

## Lyon



	<b>00.10864</b> juice, 20 cl 7,1 cm   8,6 cm pack: 6
	<b>00.10863</b> juice, 16 cl 6,6 cm   7,9 cm pack: 6

## Cibeles

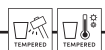

	<b>00.10201</b> juice, 14,6 cl (set of 6) 63 cm   7,5 cm pack: 1
---	--

## Habana

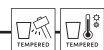

	<b>00.11304</b> wine mini, 17 cl 7 cm   7,5 cm pack: 12
---	--



## Bodega



**00.10216**  
Maxi, 51 cl  
8,8 cm | 12 cm  
pack: 12



**00.10217**  
Medium, 36,6 cl  
8,5 cm | 9,1 cm  
pack: 12



**00.10218**  
Mini, 21,5 cl  
8,2 cm | 5,8 cm  
pack: 12

## Cortina



**00.10500**  
cooler, 40 cl  
(set of 3)  
6,6 cm | 16,52 cm  
pack: 1/6



**00.10502**  
long drink, 30,5 cl  
(set of 3)  
6 cm | 16,6 cm  
pack: 1/6



**00.10501**  
water, 28 cl  
(set of 3)  
6,2 cm | 14,1 cm  
pack: 1/6



**00.10505**  
whisky, 21,5 cl  
(set of 3)  
5,5 cm | 14,3 cm  
pack: 1/6



**00.10504**  
whisky, 25 cl  
(set of 3)  
7,3 cm | 8,8 cm  
pack: 1/6



**00.10506**  
wine, 19 cl  
(set of 3)  
6,9 cm | 7,9 cm  
pack: 1/6



## Modulo



**00.13911**  
water, 30 cl  
8,4 cm | 9,5 cm  
pack: 6



**00.13910**  
water, 25 cl  
7,3 cm | 9 cm  
pack: 6

## Glit



**00.10198**  
long drink, 39,5 cl  
(set of 6)  
8,5 cm | 12 cm  
pack: 1



**00.10199**  
old fashion, 30 cl  
(set of 6)  
8,5 cm | 8,5 cm  
pack: 1

## Cube



**00.10196**  
«Cube» longdrink,  
(set of 6), 37 cl  
7,8 cm | 14,3 cm  
pack: 1

## Kaleido







**00.10197**  
«Kaleido» longdrink,  
(set of 6), 37 cl  
7,8 cm | 14,3 cm  
pack: 1

# Diamond



Χρωμαιστό γυαλί, κατάλληλα για πλυντήριο πιάτων | Infinity color. dishwasher safe.

	<b>00.10175</b> cooler 47 cl 8,6 cm   14,4 cm pack: 6		<b>00.10179</b> d.o.f. 39 cl 9,1 cm   10,3 cm pack: 6		<b>00.10171</b> water 30 cl 8,4 cm   9,3 cm pack: 6
	<b>00.10177</b> cooler «ocean blue» 47 cl 8,6 cm   14,4 cm pack: 6		<b>00.10181</b> d.o.f. «ocean blue» 39 cl 9,1 cm   10,3 cm pack: 6		<b>00.10173</b> water «ocean blue» 30 cl 8,4 cm   9,3 cm pack: 6
	<b>00.10178</b> cooler «rock purple» 47 cl 8,6 cm   14,4 cm pack: 6		<b>00.10182</b> d.o.f. «rock purple» 39 cl 9,1 cm   10,3 cm pack: 6		<b>00.10174</b> water «rock purple» 30 cl 8,4 cm   9,3 cm pack: 6



# Diamond





	<b>00.10193</b> shot, 8cl 5,9 cm   7,1 cm pack: 6/48
--	---



# Pulsar



Χρωμαιστό γυαλί, κατάλληλα για πλυντήριο πιάτων | Infinity color. dishwasher safe.

	<b>00.10159</b> cooler 47 cl 8,6 cm   14,4 cm pack: 6		<b>00.10155</b> d.o.f. 39 cl 9,1 cm   10,3 cm pack: 6		<b>00.10151</b> water 30 cl 8,4 cm   9,3 cm pack: 6
	<b>00.10161</b> cooler «ocean blue» 47 cl 8,6 cm   14,4 cm pack: 6		<b>00.10157</b> d.o.f. «ocean blue» 39 cl 9,1 cm   10,3 cm pack: 6		<b>00.10154</b> water «ocean blue» 30 cl 8,4 cm   9,3 cm pack: 6
	<b>00.10162</b> cooler «rock purple» 47 cl 8,6 cm   14,4 cm pack: 6		<b>00.10158</b> d.o.f. «rock purple» 39 cl 9,1 cm   10,3 cm pack: 6		<b>00.10152</b> water «rock purple» 30 cl 8,4 cm   9,3 cm pack: 6

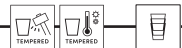

## Rock bar

	<b>00.13093</b> cooler, 47,8 cl 9 cm   13 cm pack: 6/24
	<b>00.13336</b> long drink, 37 cl 8,3 cm   12 cm pack: 6/24
	<b>00.13335</b> slim, 36,5 cl 7,9 cm   14,1 cm pack: 6/24
	<b>00.13338</b> d.o.f., 39 cl 9,1 cm   10 cm pack: 6/24
	<b>00.13343</b> rocks, 27 cl 8,4 cm   9,25 cm pack: 6/36
	<b>00.13094</b> juice, 20 cl 7,6 cm   8,4 cm pack: 6/48



## Rock bar color

	<b>00.86019</b> long drink «Ice», 37 cl 8,3 cm   12 cm pack: 6/24
	<b>00.86020</b> long drink «Mint», 37 cl 8,3 cm   12 cm pack: 6/24
	<b>00.86021</b> long drink «Peach», 37 cl 8,3 cm   12 cm pack: 6/24



## Line

	<b>00.10205</b> long drink, 39 cl (set of 6) 8,5 cm   12 cm pack: 1		<b>00.10203</b> water, rose, 29 cl (set of 6) 8,5 cm   8,5 cm pack: 1
	<b>00.10202</b> (set of 6) water, 29 cl 8,5 cm   8,5 cm pack: 1		<b>00.10204</b> water, blue, 29 cl (set of 6) 8,5 cm   8,5 cm pack: 1



## Este

	<b>00.86100</b> d.o.f., 40 cl 8,9 cm   10,7 cm pack: 6/24
--	--

## Lounge

	<b>00.86110</b> d.o.f., 40 cl 8,9cm   10,7cm pack: 6/24
--	--

## Quattro Stagioni







	<b>00.30122</b> drinking jar, 41,5 cl με καπάκι 7,8 cm   13,6 cm pack: 12
--	---

## Romantic





	<b>00.13903</b> water, 32,5 cl 7,9 cm   12,3 cm pack: 6
--	--



## Cocktail

	<b>00.14106</b> cocktail «Ypsilon», 24,5 cl 11,4 cm   18,2 cm pack: 6		<b>00.14090</b> margarita «Ypsilon», 33 cl 11,7 cm   17,4 cm pack: 6
	<b>00.10634</b> cocktail, 17 cl 9,6 cm   15,1 cm pack: 12		<b>00.13164</b> gin tonic, 76 cl (set of 6) 10,8 cm   21,8 cm pack: 1
	<b>00.14081</b> flute «Ypsilon», 16 cl 7 cm   23,5 cm pack: 6/12		<b>00.86024</b> Hurricane, 50,4 cl 8,7 cm   19,4 cm pack: 6

## Spirits



	<b>00.13146</b> cognac, 64,5 cl (set of 6) 10,8 cm   16,2 cm pack: 2
	<b>00.10228</b> cognac «Globo», 25 cl 8 cm   11,5 cm pack: 12
	<b>00.13326</b> grappa, 8,1 cl 5,6 cm   16,3 cm pack: 6/24
	<b>00.10674</b> degustazione, 21,5 cl 4,7 cm   15,5 cm pack: 6/24
	<b>00.11018</b> schnaps, 5,5 cl 5,6 cm   14,5 cm pack: 12

# BEER CLUB

## Executive

	<b>00.10859</b> beer, 52,9 cl (set of 3) 8,8 cm   20,5 cm pack: 6	(0,4)
	<b>00.10853</b> beer, 39,1 cl (set of 3) 8 cm   18,6 cm pack: 6	(0,3)
	<b>00.10847</b> beer, 26,1 cl 7 cm   16,7 cm pack: 6	(0,2)

## Harmonia

	<b>00.11408</b> beer, 58 cl 8,4 cm   21,3 cm pack: 6	(0,4)
	<b>00.11407</b> beer, 38 cl 7,3 cm   20,1 cm pack: 3/15	(0,3)
	<b>00.11406</b> beer, 27 cl 6,4 cm   18,6 cm pack: 6	(0,2)

## Ale

	<b>00.86024</b> beer, 50,4 cl 8,7 cm   19,4 cm pack: 6	
	<b>00.86023</b> beer, 42,5 cl 8,7 cm   17,4 cm pack: 6	

## Snifter

	<b>00.86026</b> beer, 53 cl 9,9 cm   15 cm pack: 6	
--	---	--

## Sestriere

	<b>00.10300</b> beer, 39 cl 7,8 cm   14,3 cm pack: 6	(0,3)
---	---	-------

## Malles

	<b>00.12366</b> beer, 31 cl 7,1 cm   12,6 cm pack: 6	(0,25)
---	---	--------

## Baviera

	<b>00.10249</b> beer, 66,8 cl 9 cm   19,7 cm pack: 6	(0,5)
---	---	-------



## Jazz

	<b>00.11800</b> long drink, 33 cl 7,1 cm   20 cm pack: 6/24	
---	--	--

	<b>00.10248</b> beer, 50,5 cl 8,4 cm   18,3 cm pack: 6	(0,4)
---	---	-------

	<b>00.10247</b> beer, 37,9 cl 7,6 cm   16,8 cm pack: 6	(0,3)
---	---	-------

## Nonix

	<b>00.86016</b> beer, 29 cl 7,4 cm   11,5 cm pack: 12	
	<b>00.86017</b> beer, 58,5 cl (set of 2) 9 cm   15,2 cm pack: 12	

## Bodega

	<b>00.10216</b> Maxi, 51 cl 8,8 cm   12 cm pack: 12	
---	--	--



# ONIS

## NEW BRAND. SAME GLASS.

ONIS είναι το νέο brand που δημιουργήθηκε από την ένωση δύο μεγάλων Ευρωπαϊκών κατασκευαστών, φέρνοντας την αυθεντικότητα και τη μοναδικότητα στην τέχνη της υαλοποιίας. Συνεχίζοντας το σχεδιασμό καθαρών γραμμών αλλά και τις υψηλές προδιαγραφές ποιότητας, οι συλλογές απευθύνονται σε μπαρ, ξενοδοχεία και εστιατόρια, εμπνέοντας τους επαγγελματίες και προσθέτοντας αξία στη δημιουργία ποτών για κάθε εκδήλωση. Στην ONIS, όλες οι λεπτομέρειες για την απόλυτη εμπειρία απόλαυσης ποτού μετράνε, γι' αυτό και κάθε ποτήρι είναι η Τελική Πινελιά!



ONIS is the new brand of two European glassmakers, who brought authenticity and uniqueness to glassmaking. Continuing to design outspoken glassware, with a statement to bars, hotels, and restaurants, inspiring professionals to add value to drink creations for every occasion. All details count when creating that ultimate drinking experience, where the glass is the finishing touch!

### LinQ grey color



XTRATUFF	
	40.00100 beverage, 41,4 cl 8,8 cm   14,6 cm pack: 12
	40.00101 beverage, 35,5 cl 8,4 cm   14 cm pack: 12
	40.00102 beverage, 29,6 cl 7,9 cm   13,4 cm pack: 12
	40.00103 d.o.f., 35,5 cl 9,6 cm   11 cm pack: 12
	40.00104 rocks, 26,6 cl 8,8 cm   10,1 cm pack: 12

### Brooklyn

XTRATUFF

	66.15797 beverage, 41,4 cl 8,8 cm   14,6 cm pack: 12
	66.15794 beverage, 35,5 cl 8,4 cm   14 cm pack: 12
	66.15796 beverage, 29,6 cl 7,9 cm   13,4 cm pack: 12
	66.15795 d.o.f., 35,5 cl 9,6 cm   11 cm pack: 12
	66.15793 rocks, 26,6 cl 8,8 cm   10,1 cm pack: 12





## Endeavor

XTRATUFF



93.15715  
cooler, 47,3 cl  
8,1 cm | 17,8 cm  
pack: 12



40.15714  
beverage, 41,4 cl  
7,9 cm | 16,8 cm  
pack: 12



40.15713  
beverage, 35,5 cl  
7,5 cm | 16 cm  
pack: 12



40.15711  
hi-ball, 29,6 cl  
7 cm | 15,9 cm  
pack: 12



40.15712  
d.o.f., 35,5 cl  
9,8 cm | 10,5 cm  
pack: 12



40.15710  
rocks, 26,6 cl  
8,9 cm | 9,8 cm  
pack: 12



## Everest

XTRATUFF



93.15437  
cooler, 41,4 cl  
8,6 cm | 12,1 cm  
pack: 36



93.15436  
beverage, 35,5 cl  
7,9 cm | 11,7 cm  
pack: 36



37.15765  
long drink, 35,5 cl  
7,4 cm | 15,9 cm  
pack: 12



37.15764  
long drink, 29,6 cl  
7 cm | 15,3 cm  
pack: 12



93.15435  
rocks, 35,5 cl  
9,5 cm | 9,2 cm  
pack: 36



37.15434  
rocks, 26,6 cl  
8,4 cm | 8,6 cm  
pack: 36



37.15433  
rocks, 23,7 cl  
8 cm | 8 cm  
pack: 36



## Rayo



37.29501 829501  
hi-ball, 36 cl  
8,4 cm | 12,9 cm  
pack: 6



37.29495 829495  
o.f., 32 cl  
8,4 cm | 10,5 cm  
pack: 6



37.29488 829488  
rocks, 26,6 cl  
8,4 cm | 8,6 cm  
pack: 6



## Tarq

XTRATUFF



37.29907 829907  
hi-ball, 34,5 cl  
8 cm | 12,7 cm  
pack: 12



37.29884 829884  
d.o.f., 35 cl  
8,9 cm | 9,8 cm  
pack: 12



37.29891 829891  
rocks, 26 cl  
8,2 cm | 8,7 cm  
pack: 12



## Endessa



40.00033  
beverage, 41 cl  
7 cm | 16,8 cm  
pack: 12



40.00036  
cooler, 35 cl  
6,7 cm | 16,2 cm  
pack: 6



40.00037  
hi-ball, 29 cl  
6,4 cm | 14,7 cm  
pack: 6



40.00038  
d.o.f., 37 cl  
8,3 cm | 10,6 cm  
pack: 12



40.00039  
whisky, 28 cl  
7,8 cm | 9,6 cm  
pack: 12

## Envy



37.23131  
hi-ball, 35 cl  
6,7 cm | 15,9 cm  
pack: 12



37.23148  
beverage, 29,6 cl  
6,4 cm | 14,6 cm  
pack: 12



37.23155  
d.o.f., 32,5 cl  
7,9 cm | 10,5 cm  
pack: 12

## Gibraltar



XTRATUFF  
40.15244  
beverage, 41,4 cl  
9 cm | 13 cm  
pack: 12



40.15235  
cooler, 35,5 cl  
7,9 cm | 14,9 cm  
pack: 12



40.15238  
beverage, 35 cl  
8,3 cm | 12,4 cm  
pack: 12



40.15383  
beverage, 31,1 cl  
7,5 cm | 14,1 cm  
pack: 12



40.15243  
d.o.f., 35 cl  
9,1 cm | 10 cm  
pack: 12



40.15231  
rocks tall, 27 cl  
8,8 cm | 9,6 cm  
pack: 12



40.15240  
rocks, 23 cl  
8,6 cm | 9 cm  
pack: 12

## Stark



40.00072  
beverage, 41 cl  
6,4 cm | 17,6 cm  
pack: 12



40.00070  
beverage, 35 cl  
6,1 cm | 16,1 cm  
pack: 12



40.00071  
d.o.f., 35 cl  
7,5 cm | 9,3 cm  
pack: 12

## Bliss



37.00001  
hi-ball, 36 cl  
6,6 cm | 14,7 cm  
pack: 6



37.00002  
hi-ball, 32 cl  
6,6 cm | 13,5 cm  
pack: 6



37.00003  
hi-ball, 29 cl  
6,3 cm | 13,1 cm  
pack: 6



37.00004  
d.o.f., 35 cl  
7,8 cm | 9,8 cm  
pack: 6



37.00005  
old fashion, 30 cl  
7,7 cm | 8,5 cm  
pack: 6

## Ensemble



40.00080  
hi-ball, 45 cl  
8,6 cm | 11,7 cm  
pack: 6



40.00081  
old fashion, 37 cl  
8,9 cm | 8,9 cm  
pack: 6

## glass can



40.00209  
glass can, 47,3 cl  
7,7 cm | 13,3 cm  
pack: 12



40.38642  
glass can, 35 cl  
7 cm | 12,2 cm  
pack: 12



40.00852  
slim can, 31,8 cl  
5,7 cm | 15 cm  
pack: 6

## Hobstar d.o.f.



37.20015  
d.o.f., 35 cl  
8,9 cm | 10,7 cm  
pack: 12



37.20048  
d.o.f. black, 35 cl  
8,9 cm | 10,7 cm  
pack: 12



37.29280  
d.o.f. green, 35 cl  
8,9 cm | 10,7 cm  
pack: 6



37.29297  
d.o.f. blue, 35 cl  
8,9 cm | 10,7 cm  
pack: 6



37.29303  
d.o.f. grey, 35 cl  
8,9 cm | 10,7 cm  
pack: 6



37.29327  
d.o.f. ocher, 35 cl  
8,9 cm | 10,7 cm  
pack: 6



37.29310  
d.o.f. rose, 35 cl  
8,9 cm | 10,7 cm  
pack: 6

## Hobstar wine



37.20044  
wine, 30 cl  
8,8 cm | 17,9 cm  
pack: 12

## Hobstar coupe



37.20054  
coupe, 25 cl  
10,3 cm | 12,2 cm  
pack: 12

## Hobstar shots



37.20045  
shot, 6 cl  
5 cm | 6,1 cm  
pack: 24

## Hobstar coolers



37.20014  
cooler, 47 cl  
8,4 cm | 15,8 cm  
pack: 12



37.20055  
cooler black, 47 cl  
8,4 cm | 15,8 cm  
pack: 12



37.29877  
hi-ball, 35 cl  
7,75 cm | 14,4 cm  
pack: 12





### The Gats



37.26609  
hi-ball, 35,5 cl  
6,8 cm | 14,8 cm  
pack: 12



37.20485  
d.o.f., 35 cl  
8,6 cm | 8,9 cm  
pack: 12



37.26982  
old fasinion, 29 cl  
8,5 cm | 8 cm  
pack: 12

### Radiant



37.27535 05636  
coller, 47,3 cl  
8,4 cm | 15,8 cm  
pack: 12



37.27542 05635  
d.o.f., 35,5 cl  
8,9 cm | 10,7 cm  
pack: 12

### Starla



40.29391  
wine, 29 cl  
8,2 cm | 16,3 cm  
pack: 12



40.29392  
water, 22 cl  
7,5 cm | 15 cm  
pack: 12



40.29393  
beverage, 27 cl  
6,7 cm | 12,8 cm  
pack: 12



40.29394  
hi-ball, 35 cl  
7,2 cm | 14,1 cm  
pack: 12



37.29549  
d.o.f., 35 cl  
8,2 cm | 10,6 cm  
pack: 12

### Carats



40.00063  
beverage, 41,4 cl  
7,8 cm | 15,4 cm  
pack: 12



40.00061  
d.o.f., 35 cl  
8,9 cm | 10,7 cm  
pack: 12

### Flashback



37.24353  
cooler, 47 cl  
7,9 cm | 16,7 cm  
pack: 12



37.24339  
d.o.f., 35,5 cl  
8,7 cm | 10,6 cm  
pack: 12

### Paneled



XTRATUFF  
37.15642 15642  
cooler, 47,3 cl  
8,4 cm | 15,4 cm  
pack: 36



66.15641 15641  
tumbler, 35,5 cl  
7,9 cm | 13,7 cm  
pack: 36



66.15640 15640  
juice, 25,1 cl  
7,6 cm | 10,3 cm  
pack: 36



66.15624 15624  
juice, 20,7 cl  
7 cm | 9,9 cm  
pack: 36



## Winchester

XTRATUFF



37.15459  
beverage, 47,3 cl  
8,3 cm | 14,9 cm  
pack: 36



37.15458  
beverage, 36 cl  
7,7 cm | 13,6 cm  
pack: 36



37.15451  
χυμίου, 20 cl  
6,4 cm | 11 cm  
pack: 36



37.15455  
rocks, 35 cl  
8,9 cm | 9,6 cm  
pack: 12



37.15457  
rocks, 29,6 cl  
8,4 cm | 9 cm  
pack: 36



37.15454  
rocks, 23,7 cl  
8 cm | 8,6 cm  
pack: 36



91.15465  
goblet, 31,1 cl  
8,3 cm | 15 cm  
pack: 36



37.15464  
wine, 25,1 cl  
7,6 cm | 14,1 cm  
pack: 36



## Modern America



40.15403  
hi-ball, 35 cl  
8,2 cm | 12,9 cm  
pack: 12



40.15400  
colins, 26 cl  
7,1 cm | 13,3 cm  
pack: 12



40.15402  
d.o.f., 34 cl  
9 cm | 10 cm  
pack: 12



40.15401  
rocks, 28 cl  
8,6 cm | 9,2 cm  
pack: 12

## Aether



37.26593  
hi-ball, 41 cl  
8,3 cm | 13,6 cm  
pack: 12



37.26586  
d.o.f., 35 cl  
9,4 cm | 9,2 cm  
pack: 12



37.26999  
hi-ball wood, 41 cl  
8,3 cm | 13,6 cm  
pack: 12



## Modern America



37.11607 411607  
coupe, 28 cl  
11,1 cm | 14,3 cm  
pack: 6



37.10556 410556  
cocktail, 22 cl  
8,1 cm | 16,6 cm  
pack: 6



37.11300 411300  
Nick & Nora, 14 cl  
6,5 cm | 17,2 cm  
pack: 6



37.11409 411409  
martini, 19 cl  
8,3 cm | 17,6 cm  
pack: 6



37.12406 412406  
gin Tonic, 59 cl  
11,1 cm | 18,9 cm  
pack: 6

## 1924



37.03005  
wine, 26,4 cl  
9 cm | 19,8 cm  
pack: 12



37.05054  
cocktail, 14 cl  
9,5 cm | 18,3 cm  
pack: 12



37.01407  
coupe, 24,5 cl  
11,3 cm | 16,1 cm  
pack: 12



37.01308  
coupe, 14 cl  
7,5 cm | 15,2 cm  
pack: 12



37.02008  
gin & tonik, 62 cl  
10,7 cm | 20,7 cm  
pack: 12



## Belém



37.25784  
wine, 18 cl  
7,4 cm | 14,4 cm  
pack: 6



37.25777  
water, 24 cl  
8,2 cm | 15,9 cm  
pack: 6



37.21734  
flute, 12 cl  
6 cm | 15,8 cm  
pack: 6



## Speak easy



37.20037  
gin & tonic  
58,5 cl  
10,3 cm | 20,3 cm  
pack: 12



37.20033  
cocktail / wine  
24 cl  
7,8 cm | 19,4 cm  
pack: 12



37.01329  
Nick & Nora  
15 cl  
7,9 cm | 16 cm  
pack: 12



37.20034  
champagne coupe  
20 cl  
9,2 cm | 15,2 cm  
pack: 12



37.20035  
martini  
19 cl  
9,9 cm | 16,4 cm  
pack: 12



\*37.17006  
champagne  
17,4 cl  
6,3 cm | 21 cm  
pack: 12



40.00015  
fizz  
25 cl  
9 cm | 16 cm  
pack: 12



37.60605 460605  
coupe, 28 cl  
11,1 cm | 16,7 cm  
pack: 6



37.97086 46103  
coupe, 12 cl  
9 cm | 15,5 cm  
pack: 6



37.30301 430301  
Nick & Nora, 15,5 cl  
8,3 cm | 17,9 cm  
pack: 6



37.40409 440409  
martini, 19 cl  
9,4 cm | 19,6 cm  
pack: 6



## Levitas



37.53134  
hi-ball, 34 cl  
5,7 cm | 17,9 cm  
pack: 12



37.53301  
d.o.f., 36 cl  
7,5 cm | 12,2 cm  
pack: 12

## cocktail



40.00066  
gin «Arôme»  
67 cl  
10,7 cm | 21,7 cm  
pack: 6



40.00062  
mixed spirits  
gin & tonic  
«Copacabana»  
60 cl  
8,9 cm | 19,5 cm  
pack: 6



37.03616  
Squall, 44 cl  
7,9 cm | 20,9 cm  
pack: 12



37.10104  
champagne  
«Happy hour», 24 cl  
9 cm | 15 cm  
pack: 6



93.08430  
margarita gourmet  
43,6 cl  
12,6 cm | 17,8 cm  
pack: 12

## cocktail



93.01619  
Napoli grande  
45,8 cl  
7,8 cm | 21,6 cm  
pack: 12



93.32802  
cooler «Bamboo»  
47,3 cl  
7,8 cm | 21,6 cm  
pack: 36

## tiki coupe



37.24704  
tiki coupe, 25 cl  
10,8 cm | 14,6 cm  
pack: 12



37.24711  
tiki mai tai, 20 cl  
9 cm | 16,3 cm  
pack: 12

## Tulip



37.43146  
bowl, 4 lt  
18 cm | 24,4 cm  
pack: 1/2



37.24476  
tumbler, 25 cl  
7,3 cm | 9,9 cm  
pack: 12

## Hedone



40.04866  
wine, 35 cl  
9,1 cm | 15,3 cm  
pack: 6



40.04827  
beverage, 34 cl  
9,2 cm | 11 cm  
pack: 12





## Perception



66.03060  
wine grande, 59,2 cl  
9,9 cm | 22,6 cm  
pack: 12



66.03011  
tall goblet, 41,4 cl  
8,6 cm | 20,8 cm  
pack: 12



66.03057  
wine, 32,5 cl  
7,9 cm | 19,8 cm  
pack: 12



66.03065  
wine, 23,7 cl  
7,5 cm | 18,3 cm  
pack: 12



66.03795  
flute, 17,8 cl  
7 cm | 19,6 cm  
pack: 12

## Beer



37.01611  
Giant beer, 68 cl  
9,2 cm | 22,4 cm  
pack: 12



37.01647  
Craft beer, 47,5 cl  
7,8 cm | 19,4 cm  
pack: 12

## Principe



40.00224  
beer / freddo, 25 cl  
6,3 cm | 17,2 cm  
pack: 24

## Gran service



37.21465  
beer, 60 cl  
11 cm | 16,1 cm  
pack: 12



37.21472  
beer, 41,5 cl  
9,8 cm | 15 cm  
pack: 12

## Profile



37.24728  
beer, 25 cl  
7,5 cm | 17 cm  
pack: 12



37.25503  
beer, 57 cl  
8,4 cm | 19 cm  
pack: 12





## Arome



37.40102  
beer tasting, 25 cl  
8 cm | 14,1 cm  
pack: 6



37.27139  
arome brandy, 29 cl  
9,2 cm | 8,8 cm  
pack: 6



37.29157  
arome tasting, 18 cl  
7,3 cm | 10,5 cm  
pack: 6



**YEO**  
37.97087 841930  
spirits balloon, 36 cl  
6 cm | 12 cm  
pack: 6



**YEO**  
37.97088 841947  
spirits balloon, 51 cl  
6,5 cm | 13 cm  
pack: 6



**YEO**  
37.97089 183139  
tall snifter, 18 cl  
4 cm | 20 cm  
pack: 6



**YEO**  
37.97090 183139  
short snifter, 18 cl  
4 cm | 14 cm  
pack: 6

## Catavinos



40.60011  
sherry «Catavinos»,  
17 cl  
4 cm | 15 cm  
pack: 24

## shots



66.05127  
shot, 4,4 cl  
5,7 cm | 7,3 cm  
pack: 48



40.00004  
«Iates», 4 cl  
3,7 cm | 6,5 cm  
pack: 12

## Esperanto



37.33227  
cocktail, 65 cl  
10,3 cm | 15,1 cm  
pack: 12



37.33340  
cocktail, 44 cl  
8,6 cm | 13,5 cm  
pack: 12





## *Super strong premier*



70.10110  
long drink, 38 cl  
6,8 cm | 14,5 cm  
pack: 6



70.10109  
hi-ball, 28 cl  
6,4 cm | 12,4 cm  
pack: 6



## *Tiara footed*



70.10103  
beverage, 40 cl  
7,4 cm | 18,5 cm  
pack: 6/48

## *Plaza*



70.10030  
tumbler, 41 cl  
7,5 cm | 15 cm  
pack: 6/48



70.10031  
tumbler, 32 cl  
7,1 cm | 14 cm  
pack: 6/72



70.10032  
d.o.f., 29,5 cl  
8,6 cm | 9 cm  
pack: 6/72



70.10033  
shot, 5,5 cl  
5,5 cm | 6 cm  
pack: 12/72

## *special*



70.10101  
«Salsa», 35,5 cl  
7,6 cm | 16,9 cm  
pack: 6/48



70.10102  
«Cuba Hurrigan»,  
45 cl  
7,3 cm | 18,8 cm  
pack: 6/24

## *Metropolitan*



70.10107  
beer, 21 cl  
6,8 cm | 13,3 cm  
pack: 6/48



70.10108  
beer, 36 cl  
7,1 cm | 16 cm  
pack: 6/48

## *beers*



70.10002  
«Pilsner», 34 cl  
7,8 cm | 16,2 cm  
pack: 6/48



70.10027  
«Hansa», 38 cl  
7 cm | 16 cm  
pack: 6/48



70.10024  
«Bavaria», 45,5 cl  
8,5 cm | 13,1 cm  
pack: 6/36

## *Tango*



70.10051  
cooler, 42,5 cl  
7,2 cm | 16,5 cm  
pack: 6/48



70.10050  
hi-ball, 31,5 cl  
6,7 cm | 14,5 cm  
pack: 6/48



70.10052  
rocks, 25,5 cl  
8,1 cm | 8,5 cm  
pack: 6/48

## *Stack*



70.10106  
«Stack», 26 cl  
6,7 cm | 9,5 cm  
pack: 6/72

## *Haiku*



70.10104  
sake «Haiku», 6 cl  
5,4 cm | 6,5 cm  
pack: 6/48





**Borgonovo®**  
made in Italy















Ο Ιταλικός όμιλος επιχειρήσεων Vetreria di Borgonovo ιδρύθηκε το 1950. Η πείρα και η φηφία των προϊόντων που παράγει στοχεύουν την επαγγελματική αγορά χρησιμοποιώντας ειδικές τεχνολογικές μεθόδους έχοντας περισσότερη αντίσταση στα σύνθετα επαθή σημεία: χείλος, πόδι και βάση, μειώνοντας έτσι κατά 30% τις απώλειες σε σπασίματα.



Italian business group Vetreria di Borgonovo was founded in 1950. The majority of products that produce targets the professional market using specific technological methods having the most resistance to the usual vulnerable points: rim, leg and base thus reducing the loss by 30% in breaks.





## Ducale

	<b>01.10693</b> wine ballon, 47 cl 7,8 cm   21,5 cm pack: 6/24		<b>01.10705</b> flute, 17 cl 4,7 cm   22 cm pack: 6/36
	<b>01.10692</b> wine, 47 cl 7,4 cm   21,5 cm pack: 6/24		<b>01.10699</b> flute, 17 cl 4,7 cm   19,8 cm pack: 6/36
	<b>01.10694</b> wine, 38 cl 6,8 cm   20,5 cm pack: 6/24		<b>01.10706</b> water, 38 cl 6,8 cm   16 cm pack: 6
	<b>01.10695</b> wine, 31 cl 6,4 cm   19,5 cm pack: 6/24		<b>01.10702</b> water, 31 cl 6,4 cm   15,4 cm pack: 6
	<b>01.10696</b> wine, 27 cl 6,2 cm   18,5 cm pack: 6/36		<b>01.10708</b> water, 27 cl 6,2 cm   14,8 cm pack: 6
	<b>01.10697</b> wine, 21 cl 5,2 cm   16,5 cm pack: 6/36		<b>01.10707</b> stemless, 52 cl 7,9 cm   10 cm pack: 6/36
			<b>01.10713</b> stemless, 38 cl 6,4 cm   10,5 cm pack: 3/36
			<b>01.10704</b> stemless, 49 cl 7 cm   11,5 cm pack: 6/36









## London

	<b>01.12234</b> wine, 19 cl 7,4 cm   11 cm pack: 12
	<b>01.12235</b> water, 25 cl 8 cm   11,9 cm pack: 6

## Mughetto



	<b>01.12322</b> wine, 17,5 cl 7 cm   11 cm pack: 12
	<b>01.12321</b> water, 24,5 cl 7,6 cm   12 cm pack: 12

## Contea

	<b>01.10906</b> wine, 49 cl 6,9 cm   22,5 cm pack: 6/24
	<b>01.10904</b> wine, 38 cl 8,7 cm   20,5 cm pack: 6/24
	<b>01.10903</b> wine, 32 cl 8,2 cm   20,2 cm pack: 6/24
	<b>01.10902</b> wine, 27 cl 7,7 cm   19 cm pack: 6/24
	<b>01.10901</b> wine, 21 cl 7,2 cm   17,8 cm pack: 6/24
	<b>01.10907</b> flute, 19 cl 4,5 cm   22 cm pack: 6/24
	<b>01.10905</b> stemless, 49 cl 6,7 cm   10,8 cm pack: 6/36
	<b>01.10908</b> stemless, 38 cl 8,5 cm   10,2 cm pack: 6/36





## Venere

	<b>01.10843</b> wine, 32 cl 8,9 cm   19,5 cm pack: 6
	<b>01.10842</b> wine, 27 cl 8,5 cm   18,5 cm pack: 6
	<b>01.10841</b> flute, 17 cl 6 cm   22 cm pack: 6

## Giglio

	<b>01.10882</b> wine, 32 cl 9,4 cm   22,3 cm pack: 6
	<b>01.10881</b> wine, 27 cl 8,6 cm   18,6 cm pack: 6
	<b>01.10880</b> flute, 17 cl 6,7 cm   23,3 cm pack: 6



## Elba

	<b>01.10870</b> water, 32 cl 9,3 cm   14,1 cm pack: 6
	<b>01.10871</b> wine, 27 cl 8,5 cm   13 cm pack: 6









## San Marco



	<b>01.13511</b> hi-ball, 40 cl 8,8 cm   13 cm pack: 6
	<b>01.13509</b> hi-ball, 30 cl 8,1 cm   12 cm pack: 6
	<b>01.13508</b> whisky, 27 cl 8,5 cm   9,2 cm pack: 6

## shots







	<b>01.14076</b> «V» 5,5 cl 6 cm   7 cm pack: 12
	<b>01.13098</b> «Palladio quadro» 6 cl 5x5 cm   6 cm pack: 48
	<b>01.10451</b> Amaro 13,5 cl 7,3 cm   7,3 cm pack: 12
	<b>01.11605</b> «Indro» vodka 6 cl 3,8 cm   10,5 cm pack: 6/72
	<b>01.10816</b> «Indro» baby 4,2 cl 4,2 cm   7 cm pack: 24
	<b>01.10832</b> «Frosty» 7 cl 5 cm   6,5 cm pack: 6

## Palladio quadro imp

	<b>01.13093</b> hi-ball, 42 cl 7,5x7,5 cm   15,4 cm pack: 6
	<b>01.13095</b> hi-ball, 32 cl 7x7cm   14 cm pack: 6
	<b>01.13094</b> d.o.f., 35 cl 8,6x8,6 cm   9,8 cm pack: 6
	<b>01.13096</b> old fashioned, 28 cl 8x8 cm   9,3 cm pack: 6



## Brera





	<b>01.10506</b> hi-ball, 62 cl 9,2 cm   14,8 cm pack: 6
	<b>01.10504</b> hi-ball, 42 cl 8,1 cm   13,7 cm pack: 6
	<b>01.10503</b> hi-ball, 35,5 cl 7,7 cm   13 cm pack: 6
	<b>01.10502</b> d.o.f., 35 cl 8,2 cm   9 cm pack: 6
	<b>01.10501</b> old fashion, 28,5 cl 7,7 cm   8,4 cm pack: 6
	<b>01.10505</b> rocks, 22 cl 8,3 cm   6,2 cm pack: 6

## Palladio quadro

	<b>01.13102</b> hi-ball, 42 cl 7,7x7,7 cm   15,4 cm pack: 6
	<b>01.13097</b> hi-ball, 32 cl 7x7cm   14 cm pack: 6
	<b>01.13101</b> d.o.f., 35 cl 8,6x8,6 cm   9,8 cm pack: 6
	<b>01.13099</b> old fashioned, 28 cl 8x8 cm   9,3 cm pack: 6



## Conic impilabile

	<b>01.10450</b> hi-ball, 42 cl 8,5 cm   15,4 cm pack: 12
	<b>01.10449</b> hi-ball, 35,5 cl 8 cm   14,3 cm pack: 6
	<b>01.10447</b> d.o.f., 35 cl 9,4 cm   9,8 cm pack: 6
	<b>01.10446</b> old fashion, 24 cl 8,5 cm   8,8 cm pack: 12



## Palladio

	<b>01.13103</b> hi-ball, 42 cl 8,7 cm   15,4 cm pack: 6
	<b>01.13104</b> d.o.f., 35 cl 9,4 cm   9,8 cm pack: 6



## Alpi

	<b>01.00008</b> (Alpi 355) hi-ball, 35,5 cl 7,9 cm   13,8 cm pack: 6/36
	<b>01.00007</b> (Alpi 355) d.o.f., 35,5 cl 8,8 cm   11 cm pack: 6/36
	<b>01.00006</b> (Alpi DOF 290) water, 29 cl 8,2 cm   10,5 cm pack: 6/36
	<b>01.00011</b> (Alpi HB 200) wine, 20 cl σε 3 τμχ. 7,5 cm   9 cm pack: 6/36

## Stelvio

	<b>01.10465</b> χυμού, 16 cl 5,9 cm   10,4 cm συσκ.: 6
---	---

## Conic

	<b>01.10430</b> bibita, 33 cl 8 cm   13,2 cm pack: 12
	<b>01.10431</b> water, 27 cl 8,5 cm   8,8 cm pack: 12

## Oval

	<b>01.10837</b> amuse bouche, 9 cl 6,5 cm   6,5 cm pack: 6
---	---

## Country

	<b>01.38049</b> drinking jar, 48 cl 6,7 cm   14,3 cm pack: 6/24
---	--





## brandy Ducale

	<b>01.00009</b> brandy, 36 cl 5,8 cm   13 cm pack: 6/24
---	--







## Frosty

	<b>01.10836</b> longdrink, 47 cl 7,3 cm   16 cm pack: 6
	<b>01.10835</b> longdrink, 30 cl 5,8 cm   15,6 cm pack: 6
	<b>01.10834</b> rocks, 33 cl 8,2 cm   10,3 cm pack: 6
	<b>01.10833</b> rocks, 25 cl 7,5 cm   9,5 cm pack: 6
	<b>01.10832</b> shot, 7 cl 5 cm   6,5 cm pack: 6



## Rococo

	<b>01.10311</b> Gin tonic, 62 cl 8,6 cm   20 cm pack: 6
	<b>01.10310</b> hi-ball, 33 cl 7 cm   11,5 cm pack: 6







## Agrippa

	<b>01.10831</b> wine, 54 cl 7,5 cm   14,5 cm pack: 6
	<b>01.10830</b> wine, 30 cl 6,5 cm   13 cm pack: 6
	<b>01.10829</b> shot, 6 cl 4,3 cm   6,8 cm pack: 6

## Excalibur

	<b>01.10320</b> hi-ball, 33 cl 7,3 cm   13,9 cm pack: 12
	<b>01.10321</b> d.o.f., 30 cl 8,3 cm   9,2 cm pack: 12

## Cocktail

	<b>01.14568</b> margarita «Ducale» 27 cl 11,2 cm   14,8 cm pack: 6/36
	<b>01.14570</b> martini, 25 cl 11,8 cm   16,8 cm pack: 6
	<b>01.14572</b> martini, 15 cl 9,5 cm   13,8 cm pack: 6
	<b>01.14571</b> martini, 10 cl 8,5 cm   13 cm pack: 6
	<b>01.10740</b> (420) cocktail «St. Tropez» 42 cl 8,2 cm   19 cm pack: 6
	<b>01.10741</b> (340) cocktail «St. Tropez» 34 cl 8 cm   16 cm pack: 6





## Sommelier



	<p><b>01.10824</b> beer, 40 cl 6,5 cm   21,5 cm pack: 6</p>
	<p><b>01.10825</b> beer, 40 cl 8,5 cm   18 cm pack: 6</p>



## Volterra

	<p><b>01.14088</b> (0,4) beer, 51,5 cl 7,2 cm   20,3 cm pack: 6</p>
	<p><b>01.14093</b> (0,3) beer, 39 cl 6,8 cm   18,3 cm pack: 6</p>
	<p><b>01.14092</b> (0,25) beer, 33 cl 6,4 cm   17,3 cm pack: 6</p>



## Monaco

	<p><b>01.10806</b> (0,3) beer, 38,5 cl 6,8 cm   21,2 cm pack: 6</p>
	<p><b>01.10803</b> (0,25) beer, 32 cl 6,5 cm   19 cm pack: 6</p>
	<p><b>01.10801</b> (0,2) beer, 27 cl 6,3 cm   17,4 cm pack: 6</p>



## Brema

	<p><b>01.11220</b> beer, 40 cl 8,1 cm   14,5 cm pack: 6</p>
	<p><b>01.11221</b> beer, 25 cl 7,1 cm   12,3 cm pack: 6</p>

## Reno

	<p><b>01.10823</b> (0,4) beer, 49,5 cl 7,3 cm   17,5 cm pack: 6</p>
	<p><b>01.10822</b> beer, 37,5 cl 6,7 cm   16,2 cm pack: 6</p>

## Icon

	<p><b>01.10809</b> (1 PINTA) beer, 58 cl 8,3 cm   16 cm pack: 6</p>
	<p><b>01.10807</b> (1/2 PINTA) beer, 29,5 cl 6,7 cm   13 cm pack: 6</p>











### Delight

	
	70.10150 9,8 cm   8,9 cm pack: 6/24
	70.10151 9,8 cm   14,8 cm pack: 6/24
	70.10152 banana split, 24x10,9 cm pack: 6/24

### Alaska



	
	00.10044 26 cl 10,4 cm   9,4 cm pack: 6

### Diamond junior

	
	00.10192 36 cl σετ 2 τμχ. 11,1 cm   9,9 cm pack: 5
	00.10183 22 cl 10,2 cm   8,6 cm pack: 12
	
	00.14121 37,5 cl 13 cm   9 cm pack: 12

### Ypsilon

### Mini Truffle



	
	90.80625 23 cl 9,5 cm   10,8 cm pack: 12

### Beach

	
	01.44064 55 cl 10,5 cm   15,4 cm pack: 6
	
	01.44065 75 cl 11,1 cm   16,9 cm pack: 6

### Florida

### Palm

	
	01.44063 35 cl 9,2 cm   12 cm pack: 6



### Acapulco



00.10004  
«Acapulco»  
30 cl  
11,6 cm | 12,5 cm  
pack: 6



00.10006  
«Acapulco junior»  
17,5 cl  
9,4 cm | 10,5 cm  
pack: 6

### Primavera



00.13104  
24 cl  
13,5 cm | 13,7 cm  
pack: 6



### Capri

οπίς



40.00065  
25 cl  
12,2 cm | 14,2 cm  
pack: 6

### London



01.12232  
milkshake, 40 cl  
8 cm | 18 cm  
pack: 6



### Fortuna



00.11064  
32 cl  
12,5 cm | 18 cm  
pack: 6



### Vicenza Mangiabevi



01.44067  
23 cl  
8,5 cm | 11,2 cm  
pack: 12



01.44058 (150)  
15 cl  
9,5 cm | 7,4 cm  
pack: 12



01.44057  
10 cl  
8,5 cm | 6,6 cm  
pack: 12

### Rock bar



00.13334  
38 cl  
8,5 cm | 18,2 cm  
pack: 6



<i>HEPP</i> .....	182-195
<i>Pintinox</i> .....	196-201
<i>Fine Dine</i> .....	202
<i>PKS</i> .....	203-205
<i>steak knives</i> .....	207-209



# *μαχαιροπίρουνα - cutlery*





Για περισσότερα από 150 χρόνια η HEPP είναι διάσημη για το «The art of service».

Η φιλοδοξία μας είναι να συνδυάζουμε το διαχρονικό με το σύγχρονο και είμαστε διάσημοι για τις εξαιρετικά εξειληγμένες σειρές προϊόντων, σχεδιασμένες από κορυφαίους σχεδιαστές.

Η νέα ταυτότητα της μάρκας δίνει έμφαση στην εξαιρετική ποιότητα των προϊόντων HEPP που παρουσιάζονται σαν έργα τέχνης. Χάρη στην αξιοπιστία, την ποιότητα και την όμορφη παρουσία των προϊόντων της, η HEPP είναι μία από τις δίγες εταιρείες που διαθέτουν πλήρη γκάμα επιτραπέζιων και ειδών μπουφέ. Η προτεραιότητά μας είναι να διασφαλίσουμε την λειτουργικότητα, την μεγάλη διάρκεια ζωής και την άμεση διαθεσιμότητα των προϊόντων μας.

For over 150 years, HEPP is known for «The art of service».

The ambition is to combine tradition and modernity, the timeless and the contemporary. The inventor of hotel silver is renowned for his exceptionally sophisticated product ranges and for outstanding pieces in collaboration with renowned product designers. Thanks to its inimitable table settings and sophisticated ambience, the HEPP brand is one of the world's leading names in refined tableware.

The new brand identity emphasizes the exceptional quality of the HEPP product world: The products are displayed as art works in order to underline the global premium quality.

Rather than an interchangeable look, this creates a new world of experiences that fascinates, touches the emotions and highlights what is already there: the natural elegance and breathtaking beauty of the HEPP world. Art as an integral component of corporate communication serves both as an experience and a hallmark. This allows the continuous implementation of the brand and recognition values to be achieved a unique character – like in the hotel industry.

Thanks to its reliable, long-lasting and high-quality products, HEPP is one of the few large global brands worldwide to offer a complete range of table- and buffetware.

Design, functionality, long service life and ensuring the availability of replacements are always the first priority.



pack:12

18/10 • 9 mm *Aves*

*30.10354	κουτάλι φαγητού   <i>table spoon</i>	21,8 cm
*30.10355	πιρούνι φαγητού   <i>table fork</i>	22 cm
*30.10356	μαχαίρι φαγητού   <i>table knife</i>	24,2 cm
*30.10357	κουτάλι φρούτου   <i>dessert spoon</i>	20,1 cm
*30.10358	πιρούνι φρούτου   <i>dessert fork</i>	19,8 cm
*30.10359	μαχαίρι φρούτου   <i>dessert knife</i>	22 cm
*30.10360	κουτάλι καφέ   <i>tea/coffee spoon</i>	13,6 cm
*30.10361	κουτάλι espresso   <i>espresso spoon</i>	10,9 cm
*30.10364	πιρούνι ψαριού   <i>fish fork</i>	19 cm
*30.10365	μαχαίρι ψαριού   <i>fish knife</i>	21 cm
*30.10366	πιρούνι κέικ   <i>cake fork</i>	16 cm
*30.10367	μαχαίρι βουτύρου   <i>butter knife</i>	17 cm
*30.10370	μαχαίρι steak   <i>steak knife</i>	24,5 cm
*30.10371	κουτάλι κονσομέ   <i>round soup spoon</i>	17,5 cm



μαχαίροπίρουνα

183

pack:12

18/10 • 5 mm *Trilogie*

30.11130	κουτάλι φαγητού   <i>table spoon</i>	21,3 cm
30.11131	πιρούνι φαγητού   <i>table fork</i>	21,1 cm
30.11132	μαχαίρι φαγητού   <i>table knife</i>	23,5 cm
30.11133	κουτάλι φρούτου   <i>dessert spoon</i>	19,5 cm
30.11134	πιρούνι φρούτου   <i>dessert fork</i>	19,3 cm
30.11135	μαχαίρι φρούτου   <i>dessert knife</i>	21,3 cm
30.11136	κουτάλι καφέ   <i>tea/coffee spoon</i>	14,2 cm
30.11137	κουτάλι espresso   <i>espresso spoon</i>	11 cm
*30.11138	πιρούνι ψαριού   <i>fish fork</i>	19 cm
*30.11139	μαχαίρι ψαριού   <i>fish knife</i>	21 cm
*30.11140	πιρουνάκι κέικ   <i>cake fork</i>	15,9 cm
*30.11141	μαχαίρι βουτύρου   <i>butter knife</i>	17,5 cm
*30.11142	μαχαίρι steak   <i>steak knife</i>	23,8 cm
*30.11143	κουτάλι κονσομέ   <i>round soup spoon</i>	17 cm



HEPP

## Accent 18/10 • 5,5 mm

pack:12



30.10000	κουτάλι φαγητού   <i>table spoon</i>	20,3 cm
30.10001	πιρούνι φαγητού   <i>table fork</i>	20,2 cm
30.10002	μαχαίρι φαγητού   <i>table knife Solid</i>	23 cm
30.10003	κουτάλι φρούτου   <i>dessert spoon</i>	18 cm
30.10004	πιρούνι φρούτου   <i>dessert fork</i>	17,9 cm
30.10005	μαχαίρι φρούτου   <i>dessert knife solid</i>	22 cm
30.10006	κουτάλι καφέ   <i>tea/coffee spoon</i>	13,2 cm
30.10007	μαχαίρι βουτύρου   <i>butter knife Solid</i>	17 cm
*30.10082	μαχαίρι φαγητού φαρδύ   <i>wide table knife Solid</i>	23 cm
*30.10083	μαχαίρι φρούτου φαρδύ   <i>wide dessert knife Solid</i>	22 cm
*30.10080	κουτάλι κονσομέ   <i>round soup spoon</i>	17,6 cm
*30.10081	πιρουνάκι κέικ   <i>cake fork</i>	15,1 cm
*30.10077	κουταλάκι espresso   <i>espresso spoon</i>	11 cm

184

## Profile 18/10 • 5 mm

pack:12



30.10048	κουτάλι φαγητού   <i>table spoon</i>	20,6 cm
30.10049	πιρούνι φαγητού   <i>table fork</i>	20,8 cm
30.10050	μαχαίρι φαγητού   <i>table knife Solid</i>	23 cm
30.10051	κουτάλι φρούτου   <i>dessert spoon</i>	18,3 cm
30.10052	πιρούνι φρούτου   <i>dessert fork</i>	18,5 cm
30.10053	μαχαίρι φρούτου   <i>dessert knife solid</i>	20,2 cm
30.10054	κουτάλι καφέ   <i>tea/coffee spoon</i>	14 cm
30.10055	μαχαίρι βουτύρου   <i>butter knife Solid</i>	17 cm
*30.10126	μαχ. φαγητού "S"   <i>table knife</i>	23 cm
*30.10127	μαχ. φρούτου "S"   <i>dessert knife</i>	20,2 cm
*30.10122	κουτάλι κονσομέ   <i>round soup spoon</i>	18,2 cm
*30.10123	πιρουνάκι κέικ   <i>cake fork</i>	15,5 cm
*30.10119	κουταλάκι espresso   <i>espresso spoon</i>	11 cm
*30.10120	μαχαίρι ψαριού   <i>fish knife Solid</i>	20,5 cm
*30.10121	πιρούνι ψαριού   <i>fish fork</i>	18,5 cm
*30.10125	μαχαίρι βουτύρου "S"   <i>butter knife</i>	16,5 cm

30.10208	κουτάλι φαγητού   <i>table spoon</i>	23 cm
30.10207	πιρούνι φαγητού   <i>table fork</i>	22,8 cm
30.10206	μαχαίρι φαγητού   <i>table knife</i>	24,6 cm
30.10309	κουτάλι φρούτου   <i>dessert spoon</i>	20,6 cm
30.10310	πιρούνι φρούτου   <i>dessert fork</i>	20,4 cm
30.10311	μαχαίρι φρούτου   <i>dessert knife</i>	22 cm
30.10209	κουτάλι καφέ   <i>tea/coffee spoon</i>	15,7 cm
30.10217	κουτάλι espresso   <i>espresso spoon</i>	11 cm
*30.10313	πιρούνι ψαριού   <i>fish fork</i>	21,4 cm
*30.10314	μαχαίρι ψαριού   <i>fish knife</i>	23,1 cm
30.10315	μαχαίρι βουτύρου   <i>butter knife</i>	18,5 cm
30.10210	πιρουνάκι κέικ   <i>cake fork</i>	17,2 cm
*30.10317	μαχαίρι steak   <i>steak knife</i>	24,9 cm
*30.10318	κουτάλι κονσομέ   <i>round soup spoon</i>	19 cm
*30.10312	κουτάλι dressing   <i>dressing spoon</i>	20,9 cm
*30.10316	κουτάλι γρανίτας   <i>iced tea spoon</i>	22 cm



*30.10319	κουτάλι φαγητού   <i>table spoon</i>	21,7 cm
*30.10320	πιρούνι φαγητού   <i>table fork</i>	21,5 cm
*30.10321	μαχαίρι φαγητού   <i>table knife</i>	23,6 cm
*30.10322	κουτάλι φρούτου   <i>dessert spoon</i>	19,9 cm
*30.10323	πιρούνι φρούτου   <i>dessert fork</i>	19,7 cm
*30.10324	μαχαίρι φρούτου   <i>dessert knife</i>	22,1 cm
*30.10325	κουτάλι καφέ   <i>tea/coffee spoon</i>	13,7 cm
*30.10326	κουτάλι espresso   <i>espresso spoon</i>	11 cm
*30.10328	πιρούνι ψαριού   <i>fish fork</i>	19,5 cm
*30.10329	μαχαίρι ψαριού   <i>fish knife</i>	21,5 cm
*30.10330	πιρούνι κέικ   <i>cake fork</i>	15,8 cm
*30.10331	μαχαίρι βουτύρου   <i>butter knife</i>	17 cm
*30.10335	κουτάλι κονσομέ   <i>round soup spoon</i>	17 cm





## Aura 18/10 • 5 mm

pack:12



30.10212	κουτάλι φαγητού   <i>table spoon</i>	21,1 cm
30.10211	προύνι φαγητού   <i>table fork</i>	21 cm
30.10213	μαχαίρι φαγητού   <i>table knife</i>	23,9 cm
30.10218	κουτάλι φρούτου   <i>dessert spoon</i>	18,6 cm
30.10247	προύνι φρούτου   <i>dessert fork</i>	18,3 cm
30.10288	μαχαίρι φρούτου   <i>dessert knife</i>	20,1 cm
30.10215	κουτάλι καφέ   <i>tea/coffee spoon</i>	14,2 cm
*30.10216	κουτάλι espresso   <i>espresso spoon</i>	11,4 cm
30.10292	προυνάκι κέικ   <i>cake fork</i>	15,1 cm
*30.10293	μαχαίρι ψαριού   <i>fish knife</i>	20,4 cm
*30.10294	προύνι ψαριού   <i>fish fork</i>	18 cm
30.10295	μαχαίρι βουτύρου   <i>butter knife</i>	17 cm
*30.10296	κουτάλι κονσομέ   <i>round soup spoon</i>	18 cm
*30.10298	μαχαίρι steak   <i>steak knife</i>	22,3 cm

186

## Ecco 18/10 • 3 mm

pack:12



30.10032	κουτάλι φαγητού   <i>table spoon</i>	21,7 cm
30.10033	προύνι φαγητού   <i>table fork</i>	21,5 cm
30.10034	μαχαίρι φαγητού   <i>table knife Solid</i>	23,6 cm
30.10035	κουτάλι φρούτου   <i>dessert spoon</i>	19,9 cm
30.10036	προύνι φρούτου   <i>dessert fork</i>	19,7 cm
30.10037	μαχαίρι φρούτου   <i>dessert knife solid</i>	22,1 cm
30.10038	κουτάλι καφέ   <i>tea/coffee spoon</i>	13,2 cm
30.10039	μαχαίρι βουτύρου   <i>butter knife Solid</i>	17 cm
*30.10108	κουτάλι κονσομέ   <i>round soup spoon</i>	16,6 cm
*30.10106	προυνάκι κέικ   <i>cake fork</i>	15,7 cm
*30.10103	κουταλάκι espresso   <i>espresso spoon</i>	10,8 cm
*30.10105	μαχαίρι ψαριού   <i>fish knife Solid</i>	18,4 cm
*30.10104	προύνι ψαριού   <i>fish fork</i>	20,6 cm
*30.10107	κουτάλι παγωτού   <i>iced tea spoon</i>	22 cm
*30.10102	μαχαίρι steak   <i>steak knife Solid</i>	23,6 cm

pack:12

18/10 • 5 mm *Royal*

*30.10236	κουτάλι φαγητού   <i>table spoon</i>	20,7 cm
*30.10235	πιρούνι φαγητού   <i>table fork</i>	20,8 cm
*30.10234	μαχαίρι φαγητού   <i>table knife</i>	23,7 cm
*30.10204	κουτάλι φρούτου   <i>dessert spoon</i>	18,2 cm
*30.10203	πιρούνι φρούτου   <i>dessert fork</i>	18 cm
*30.10202	μαχαίρι φρούτου   <i>dessert knife</i>	20,6 cm
*30.10205	κουτάλι καφέ   <i>tea/coffee spoon</i>	14,8 cm
*30.10302	κουτάλι espresso   <i>espresso spoon</i>	11,5 cm
*30.10289	πιρούνι κέικ   <i>cake fork</i>	15,3 cm
*30.10303	μαχαίρι ψαριού   <i>fish knife</i>	20,3 cm
*30.10304	πιρούνι ψαριού   <i>fish fork</i>	17,8 cm
*30.10306	μαχαίρι βουτύρου   <i>butter knife</i>	17 cm
*30.10308	κουτάλι κονσομέ   <i>round soup spoon</i>	17,8 cm
*30.10290	μαχαίρι steak   <i>steak knife</i>	23,4 cm



μαχαίροπίρουνα

187

pack:12

18/10 • 4 mm *Medan*

*30.10372	κουτάλι φαγητού   <i>table spoon</i>	21,4 cm
*30.10373	πιρούνι φαγητού   <i>table fork</i>	21,2 cm
*30.10375	μαχαίρι φαγητού   <i>table knife</i>	23,7 cm
*30.10376	κουτάλι φρούτου   <i>dessert spoon</i>	19,6 cm
*30.10377	πιρούνι φρούτου   <i>dessert fork</i>	19,4 cm
*30.10379	μαχαίρι φρούτου   <i>dessert knife</i>	21,7 cm
*30.10380	κουτάλι καφέ   <i>tea/coffee spoon</i>	13,6 cm
*30.10381	κουτάλι espresso   <i>espresso spoon</i>	10,8 cm
*30.10384	πιρούνι ψαριού   <i>fish fork</i>	19 cm
*30.10385	μαχαίρι ψαριού   <i>fish knife</i>	21,2 cm
*30.10386	μαχαίρι βουτύρου   <i>butter knife</i>	17 cm
*30.10388	πιρούνι κέικ   <i>cake fork</i>	15,9 cm
*30.10390	κουτάλι κονσομέ   <i>round soup spoon</i>	17 cm
*30.10389	μαχαίρι steak   <i>steak knife</i>	23,9 cm



HEPP

## Mescana 18/10 • 4 mm

pack:12



*30.10248	κουτάλι φαγητού   <i>table spoon</i>	21,4 cm
*30.10249	προύνι φαγητού   <i>table fork</i>	21,1 cm
*30.10251	μαχαίρι φαγητού   <i>table knife</i>	23,7 cm
*30.10252	κουτάλι φρούτου   <i>dessert spoon</i>	19,5 cm
*30.10253	προύνι φρούτου   <i>dessert fork</i>	19,3 cm
*30.10255	μαχαίρι φρούτου   <i>dessert knife</i>	21,3 cm
*30.10256	κουτάλι καφέ   <i>tea/coffee spoon</i>	13,5 cm
*30.10238	κουτάλι espresso   <i>espresso spoon</i>	11 cm
*30.10264	προυνάκι κέικ   <i>cake fork</i>	16 cm
*30.10259	προύνι ψαριού   <i>fish fork</i>	19 cm
*30.10260	μαχαίρι ψαριού   <i>fish knife</i>	21 cm
*30.10262	μαχαίρι βουτύρου   <i>butter knife</i>	17 cm
*30.10267	κουτάλι κονσομέ   <i>round soup spoon</i>	17 cm
*30.10266	μαχαίρι steak   <i>steak knife</i>	23,8 cm

188

## Baguette 18/10 • 3 mm

pack:12



30.10008	κουτάλι φαγητού   <i>table spoon</i>	20,5 cm
30.10009	προύνι φαγητού   <i>table fork</i>	20,6 cm
30.10010	μαχαίρι φαγητού   <i>table knife Solid</i>	24 cm
30.10011	κουτάλι φρούτου   <i>dessert spoon</i>	19 cm
30.10012	προύνι φρούτου   <i>dessert fork</i>	18,2 cm
30.10013	μαχαίρι φρούτου   <i>dessert knife Solid</i>	21,2 cm
30.10014	κουτάλι καφέ   <i>tea/coffee spoon</i>	13,5 cm
30.10015	μαχαίρι βουτύρου   <i>butter knife Solid</i>	17 cm
*30.10094	μαχ. φαγητού   <i>table knife Hollow</i>	24,5 cm
*30.10095	μαχ. φρούτου   <i>dessert knife Hollow</i>	21,1 cm
*30.10101	κουτάλι κονσομέ   <i>round soup spoon</i>	18 cm
*30.10097	προυνάκι κέικ   <i>cake fork</i>	15,5 cm
*30.10096	κουταλάκι espresso   <i>espresso spoon</i>	11,1 cm
*30.10098	μαχαίρι ψαριού   <i>fish knife Solid</i>	19,8 cm
*30.10099	προύνι ψαριού   <i>fish fork</i>	17,9 cm
*30.10100	μαχαίρι steak   <i>steak knife Hollow</i>	23 cm

HEPP

pack:12

18/10 • 3,2 mm *Carlton*

30.10016	κουτάλι φαγητού   <i>table spoon</i>	20,5 cm
30.10017	πιρούνι φαγητού   <i>table fork</i>	20,1 cm
30.10018	μαχαίρι φαγητού   <i>table knife Solid</i>	23,7 cm
30.10019	κουτάλι φρούτου   <i>dessert spoon</i>	18 cm
30.10020	πιρούνι φρούτου   <i>dessert fork</i>	18 cm
30.10021	μαχαίρι φρούτου   <i>dessert knife Solid</i>	21,5 cm
30.10022	κουτάλι καφέ   <i>tea/coffee spoon</i>	14 cm
30.10023	μαχαίρι βουτύρου   <i>butter knife Solid</i>	17 cm
*30.10085	μαχ. φαγητού   <i>table knife Hollow</i>	23,7 cm
*30.10086	μαχ. φρούτου   <i>dessert knife Hollow</i>	21 cm
*30.10092	κουτάλι κονσομέ   <i>round soup spoon</i>	17,5 cm
*30.10088	πιρουνάκι κέικ   <i>cake fork</i>	15,5 cm
*30.10087	κουταλάκι espresso   <i>espresso spoon</i>	11 cm
*30.10089	μαχαίρι ψαριού   <i>fish knife Solid</i>	20 cm
*30.10090	πιρούνι ψαριού   <i>fish fork</i>	17,5 cm
*30.10091	μαχαίρι steak   <i>steak knife Hollow</i>	23 cm
*30.10093	μαχαίρι steak   <i>steak knife Solid</i>	23 cm



μαχαίροπίρουνα

189

pack:12

18/10 • 3,5 mm *Chippendale*

30.10024	κουτάλι φαγητού   <i>table spoon</i>	20,5 cm
30.10025	πιρούνι φαγητού   <i>table fork</i>	20,8 cm
30.10026	μαχαίρι φαγητού   <i>table knife Solid</i>	23,7 cm
30.10027	κουτάλι φρούτου   <i>dessert spoon</i>	18,2 cm
30.10028	πιρούνι φρούτου   <i>dessert fork</i>	18,4 cm
30.10029	μαχαίρι φρούτου   <i>dessert knife solid</i>	21,1 cm
30.10030	κουτάλι καφέ   <i>tea/coffee spoon</i>	14 cm
30.10031	μαχαίρι βουτύρου   <i>butter knife Solid</i>	17,1 cm
*30.10109	μαχ. φαγητού   <i>table knife Hollow</i>	23,7 cm
*30.10110	μαχ. φρούτου   <i>dessert knife Hollow</i>	21,1 cm
*30.10116	κουτάλι κονσομέ   <i>round soup spoon</i>	17,7 cm
*30.10112	πιρουνάκι κέικ   <i>cake fork</i>	15,5 cm
*30.10111	κουταλάκι espresso   <i>espresso spoon</i>	10,9 cm
*30.10113	μαχαίρι ψαριού   <i>fish knife Solid</i>	20,4 cm
*30.10114	πιρούνι ψαριού   <i>fish fork</i>	18,2 cm
*30.10115	μαχαίρι βουτύρου   <i>butter knife Hollow</i>	17,1 cm
*30.10117	μαχαίρι steak   <i>steak knife Hollow</i>	23,1 cm
*30.10118	μαχαίρι steak   <i>steak knife Solid</i>	23,1 cm



HEPP

## Contour 18/10 • 3 mm

pack:12



30.10040	κουτάλι φαγητού   <i>table spoon</i>	20,2 cm
30.10041	προύνι φαγητού   <i>table fork</i>	20,5 cm
30.10042	μαχαίρι φαγητού   <i>table knife Solid</i>	22,6 cm
30.10043	κουτάλι φρούτου   <i>dessert spoon</i>	17,7 cm
30.10044	προύνι φρούτου   <i>dessert fork</i>	17,8 cm
30.10045	μαχαίρι φρούτου   <i>dessert knife solid</i>	20,6 cm
30.10046	κουτάλι καφέ   <i>tea/coffee spoon</i>	13,8 cm
30.10047	μαχαίρι βουτύρου   <i>butter knife Solid</i>	17 cm
*30.10128	μαχ. φαγητού   <i>table knife Hollow</i>	22,6 cm
*30.10129	μαχ. φρούτου   <i>dessert knife Hollow</i>	20,6 cm
*30.10135	κουτάλι κονσομέ   <i>round soup spoon</i>	17,2 cm
*30.10131	προυνάκι κέικ   <i>cake fork</i>	15,3 cm
*30.10130	κουταλάκι espresso   <i>espresso spoon</i>	11,8 cm
*30.10132	μαχαίρι ψαριού   <i>fish knife Solid</i>	21,4 cm
*30.10133	προύνι ψαριού   <i>fish fork</i>	17,5 cm
*30.10136	μαχ. βουτύρου ίσιο   <i>butter knife Solid</i>	16,5 cm
*30.10134	μαχαίρι steak   <i>steak knife Hollow</i>	23 cm

190

## Exclusiv 18/10 • 3,5 mm

pack:12



*30.10425	κουτάλι φαγητού   <i>table spoon</i>	20,3 cm
*30.10426	προύνι φαγητού   <i>table fork</i>	20,3 cm
*30.10429	μαχαίρι φαγητού   <i>table knife</i>	23,8 cm
*30.10412	κουτάλι φρούτου   <i>dessert spoon</i>	18 cm
*30.10413	προύνι φρούτου   <i>dessert fork</i>	18 cm
*30.10430	μαχαίρι φρούτου   <i>dessert knife</i>	20,9 cm
*30.10415	κουτάλι καφέ   <i>tea/coffee spoon</i>	13,3 cm
*30.10416	κουτάλι espresso   <i>espresso spoon</i>	11,5 cm
*30.10428	προυνάκι κέικ   <i>cake fork</i>	15 cm
*30.10418	προύνι ψαριού   <i>fish fork</i>	17,3 cm
*30.10417	μαχαίρι ψαριού   <i>fish knife</i>	20,3 cm
*30.10421	μαχαίρι βουτύρου   <i>butter knife</i>	16,3 cm
*30.10424	κουτάλι κονσομέ   <i>round soup spoon</i>	15 cm
*30.10422	μαχαίρι steak   <i>steak knife Hollow</i>	22,4 cm

pack:12

18/10 • 2,8 mm *Lenista*

*30.11015	κουτάλι φαγητού   <i>table spoon</i>	21,7 cm
*30.11014	πιρούνι φαγητού   <i>table fork</i>	21,5 cm
*30.11016	μαχαίρι φαγητού   <i>table knife</i>	23,6 cm
*30.11019	κουτάλι επιδορπίου   <i>dessert spoon</i>	19,9 cm
*30.11018	πιρούνι επιδορπίου   <i>dessert fork</i>	19,7 cm
*30.11020	μαχαίρι επιδορπίου   <i>dessert knife</i>	22,1 cm
*30.11022	πιρούνι φρούτου   <i>dessert fork</i>	15,8 cm
*30.11029	μαχαίρι φρούτου   <i>dessert knife</i>	18 cm
*30.11030	κουτάλι γλυκού   <i>cake spoon</i>	15,9 cm
*30.11027	πιρουνάκι κέικ   <i>cake fork</i>	15,8 cm
*30.11026	κουτάλι καφέ   <i>coffee spoon</i>	13,7 cm
*30.11023	κουτάλι espresso   <i>espresso spoon</i>	11 cm
*30.11025	μαχαίρι ψαριού   <i>fish knife</i>	20,3 cm
*30.11024	πιρούνι ψαριού   <i>fish fork</i>	19,5 cm
*30.11021	μαχαίρι βουτύρου   <i>butter knife</i>	17 cm
*30.11017	κουτάλι κονσομέ   <i>round soup spoon</i>	17 cm
*30.11028	κουτάλι παγωτού   <i>ice cream spoon</i>	22 cm



μαχαίροπίρουνα

191

pack:12

18/10 • 3,5 mm *Kreuzband*

*30.10391	κουτάλι φαγητού   <i>table spoon</i>	20,9 cm
*30.10392	πιρούνι φαγητού   <i>table fork</i>	20,9 cm
*30.10410	μαχαίρι φαγητού   <i>table knife</i>	24,8 cm
*30.10393	κουτάλι φρούτου   <i>dessert spoon</i>	17,8 cm
*30.10394	πιρούνι φρούτου   <i>dessert fork</i>	18 cm
*30.10411	μαχαίρι φρούτου   <i>dessert knife</i>	21,3 cm
*30.10395	κουτάλι καφέ   <i>tea/coffee spoon</i>	14,2 cm
*30.10396	κουτάλι espresso   <i>espresso spoon</i>	10,9 cm
*30.10397	πιρουνάκι κέικ   <i>cake fork</i>	15,9 cm
*30.10398	μαχαίρι ψαριού   <i>fish knife</i>	20,3 cm
*30.10399	πιρούνι ψαριού   <i>fish fork</i>	18 cm
*30.10403	μαχαίρι βουτύρου   <i>butter knife</i>	17 cm
*30.10408	κουτάλι κονσομέ   <i>round soup spoon</i>	18 cm
*30.10404	μαχαίρι steak   <i>steak knife</i>	23,4 cm



HEPP

## Diamond 18/10 • 3,2 mm

pack:12



*30.10434	κουτάλι φαγητού   <i>table spoon</i>	20,5 cm
*30.10435	προύνι φαγητού   <i>table fork</i>	20,5 cm
*30.10449	μαχαίρι φαγητού   <i>table knife</i>	22,8 cm
*30.10437	κουτάλι φρούτου   <i>dessert spoon</i>	18 cm
*30.10438	προύνι φρούτου   <i>dessert fork</i>	18 cm
*30.10450	μαχαίρι φρούτου   <i>dessert knife</i>	20,6 cm
*30.10440	κουτάλι καφέ   <i>tea/coffee spoon</i>	14 cm
*30.10441	κουτάλι espresso   <i>espresso spoon</i>	12 cm
*30.10442	προύνι κέικ   <i>cake fork</i>	15,5 cm
*30.10443	μαχαίρι ψαριού   <i>fish knife</i>	20,8 cm
*30.10444	προύνι ψαριού   <i>fish fork</i>	19,1 cm
*30.10446	μαχαίρι βουτύρου   <i>butter knife</i>	17 cm
*30.10448	κουτάλι κονσομέ   <i>round soup spoon</i>	17,5 cm
*30.10479	μαχαίρι steak   <i>steak knife</i>	23,6 cm

192

## Trend 18/10 • 2,5 mm

pack:12



*30.10473	κουτάλι φαγητού   <i>table spoon</i>	19,7 cm
*30.10474	προύνι φαγητού   <i>table fork</i>	19,3 cm
*30.10477	μαχαίρι φαγητού   <i>table knife</i>	21,7 cm
*30.10466	κουτάλι φρούτου   <i>dessert spoon</i>	18 cm
*30.10467	προύνι φρούτου   <i>dessert fork</i>	17,5 cm
*30.10478	μαχαίρι φρούτου   <i>dessert knife</i>	20,1 cm
*30.10468	κουτάλι καφέ   <i>tea/coffee spoon</i>	13,9 cm
*30.10469	κουτάλι espresso   <i>espresso spoon</i>	11,8 cm
*30.10475	μαχαίρι ψαριού   <i>fish knife</i>	20,3 cm
*30.10470	προύνι ψαριού   <i>fish fork</i>	18 cm
*30.10472	κουτάλι κονσομέ   <i>round soup spoon</i>	17,8 cm
*30.10476	προύνι κέικ   <i>cake fork</i>	14,2 cm

*30.10463	κουτάλι φαγητού   <i>table spoon</i>	19,3 cm
*30.10464	πιρούνι φαγητού   <i>table fork</i>	19,4 cm
*30.10453	μαχαίρι φαγητού   <i>table knife</i>	20,7 cm
*30.10457	κουτάλι φρούτου   <i>dessert spoon</i>	17,9 cm
*30.10458	πιρούνι φρούτου   <i>dessert fork</i>	18 cm
*30.10454	μαχαίρι φρούτου   <i>dessert knife</i>	19,6 cm
*30.10459	κουτάλι καφέ   <i>tea/coffee spoon</i>	13,5 cm
*30.10460	κουτάλι espresso   <i>espresso spoon</i>	11 cm
*30.10461	παγωτού   <i>iced tea spoon</i>	20,9 cm
*30.10462	κουτάλι κονσομέ   <i>round soup spoon</i>	17,9 cm
*30.10480	μαχαίρι ψαριού   <i>fish knife</i>	20,3 cm
*30.10465	πιρούνι κέικ   <i>cake fork</i>	14 cm
*30.10455	μαχαίρι βουτύρου   <i>butter knife</i>	17 cm
*30.10456	μαχαίρι steak   <i>steak knife</i>	22 cm





## Ειδικές εκδόσεις μαχαιροπίρουνων

Μπορείτε να προσαρμόσετε τα μαχαιροπίρουνά σας στις ιδιαίτερες αισθητικές απαιτήσεις σας, επιλέγοντας το χρωματισμό και την υφή που αυτά θέλετε να έχουν:

επιλογές χρωματισμών:

- Gold (χρυσό)
- Pale gold (ανοικτό χρυσό)
- Gunmetal (ανθρακί)
- Bronze (χαλκός)

επιλογές υφής:

- Matt (σατινέ)
- Stone-washed (πειροπιδυμένη)
- Brushed (βουρτσοποιημένη)



## Profile stonewashed 18/10 • 5 mm pack:12



30.11072	κουτάλι φαγητού   <i>table spoon</i>	20,6 cm
30.11073	προύνι φαγητού   <i>table fork</i>	20,8 cm
30.11074	μαχαίρι φαγητού   <i>table knife Solid</i>	23 cm
30.11075	κουτάλι φρούτου   <i>dessert spoon</i>	18,3 cm
30.11076	προύνι φρούτου   <i>dessert fork</i>	18,5 cm
30.11077	μαχαίρι φρούτου   <i>dessert knife solid</i>	20,2 cm
30.11078	κουτάλι καφέ   <i>tea/coffee spoon</i>	14 cm

30.10959	κουτάλι φαγητού   <i>table spoon</i>	21,7 cm
30.10960	πιρούνι φαγητού   <i>table fork</i>	21,5 cm
30.10961	μαχαίρι φαγητού   <i>table knife Solid</i>	23,6 cm
30.10962	κουτάλι φρούτου   <i>dessert spoon</i>	19,9 cm
30.10963	πιρούνι φρούτου   <i>dessert fork</i>	19,7 cm
30.10964	μαχαίρι φρούτου   <i>dessert knife solid</i>	22,1 cm
30.10965	κουτάλι καφέ   <i>tea/coffee spoon</i>	13,2 cm
*30.10970	μαχαίρι βουτύρου   <i>butter knife Solid</i>	17 cm
*30.10974	κουτάλι κονσομέ   <i>round soup spoon</i>	16,6 cm
*30.10972	πιρουνάκι κέικ   <i>cake fork</i>	15,7 cm
*30.10966	κουταλάκι espresso   <i>espresso spoon</i>	10,8 cm
*30.10969	μαχαίρι ψαριού   <i>fish knife Solid</i>	18,4 cm
*30.10968	πιρούνι ψαριού   <i>fish fork</i>	20,6 cm
*30.10967	κουτάλι dressing   <i>dressing spoon</i>	20,9 cm
*30.10971	κουτάλι παγωτού   <i>iced tea spoon</i>	22 cm
*30.10973	μαχαίρι steak   <i>steak knife Solid</i>	23,6 cm



30.10975	κουτάλι φαγητού   <i>table spoon</i>	21,7 cm
30.10976	πιρούνι φαγητού   <i>table fork</i>	21,5 cm
30.10977	μαχαίρι φαγητού   <i>table knife Solid</i>	23,6 cm
30.10978	κουτάλι φρούτου   <i>dessert spoon</i>	19,9 cm
30.10979	πιρούνι φρούτου   <i>dessert fork</i>	19,7 cm
30.10980	μαχαίρι φρούτου   <i>dessert knife solid</i>	22,1 cm
30.10981	κουτάλι καφέ   <i>tea/coffee spoon</i>	13,2 cm
*30.10986	μαχαίρι βουτύρου   <i>butter knife Solid</i>	17 cm
*30.10990	κουτάλι κονσομέ   <i>round soup spoon</i>	16,6 cm
*30.10988	πιρουνάκι κέικ   <i>cake fork</i>	15,7 cm
*30.10982	κουταλάκι espresso   <i>espresso spoon</i>	10,8 cm
*30.10985	μαχαίρι ψαριού   <i>fish knife Solid</i>	18,4 cm
*30.10984	πιρούνι ψαριού   <i>fish fork</i>	20,6 cm
*30.10983	κουτάλι dressing   <i>dressing spoon</i>	20,9 cm
*30.10987	κουτάλι παγωτού   <i>iced tea spoon</i>	22 cm
*30.10989	μαχαίρι steak   <i>steak knife Solid</i>	23,6 cm



# PINTINOX

Η εταιρία ξεκίνησε τις δραστηριότητες της το 1929, και παραμένει έως σήμερα ο μεγαλύτερος παράγωγος μαχαιροπήρουνων στην Ιταλία.

Επίσης, παράγει ποιοτικά ανοξείδωτα σκευή και καινοτόμα ειδη μπουφέ.

*The company started its activities in 1929 and still is the first producer of cutlery in Italy.*

*It also produces quality cooking utensils and innovative buffet items.*

## Synthesis 18/10 • 3 mm

pack:12/120



19.24330	μαχαίρι φαγητού   table knife	22,5 cm
19.24331	πιρούνι φαγητού   table fork	21,2 cm
19.24332	κουτάλι φαγητού   table spoon	21 cm
19.24341	μαχαίρι φρούτου   dessert knife	20,1 cm
19.24334	πιρούνι φρούτου   dessert fork	18,2 cm
19.24340	κουτάλι φρούτου   dessert spoon	18,3 cm
19.24337	πιρούνι γλυκού   cake fork	16,1 cm
19.24336	κουτάλι γλυκού   tea/coffee spoon	14,8 cm
19.24339	κουτάλι μόκας   moca spoon	10,9 cm

## Tecna 18/10 • 3 mm

pack:12/120



19.24240	μαχαίρι φαγητού   table knife	24 cm
19.24241	πιρούνι φαγητού   table fork	23 cm
19.24242	κουτάλι φαγητού   table spoon	23 cm
19.24243	μαχαίρι φρούτου   dessert knife	21 cm
19.24244	πιρούνι φρούτου   dessert fork	19,9 cm
19.24245	κουτάλι φρούτου   dessert spoon	20 cm
19.24247	πιρούνι γλυκού   cake fork	17 cm
19.24246	κουτάλι γλυκού   tea/coffee spoon	17 cm
19.24248	κουτάλι μόκας   moca spoon	10,9 cm
*19.24249	μαχαίρι ψαριού   fish knife	21,8 cm
*19.24250	πιρούνι ψαριού   fish fork	19,9 cm
*19.24251	πιρούνι σερβιρίσματος   serving fork	26 cm
*19.24252	κουτάλι σερβιρίσματος   serving spoon	26 cm





pack: 12/120 18/10 • 3 mm *Palace*



19.24166	μαχαίρι φαγητού   <i>table knife</i>	23,4 cm
19.24167	πιρούνι φαγητού   <i>table fork</i>	21 cm
19.24168	κουτάλι φαγητού   <i>table spoon</i>	21 cm
19.24146	μαχαίρι φρούτου   <i>dessert knife</i>	21 cm
19.24154	πιρούνι φρούτου   <i>dessert fork</i>	18,2 cm
19.24147	κουτάλι φρούτου   <i>dessert spoon</i>	18,2 cm
19.24149	πιρούνι γλυκού   <i>cake fork</i>	14,6 cm
19.24169	κουτάλι γλυκού   <i>tea/coffee spoon</i>	14,7 cm
19.24148	κουτάλι μόκας   <i>moca spoon</i>	10,8 cm
*19.24159	μαχαίρι ψαριού   <i>fish knife</i>	20,3 cm
*19.24160	πιρούνι ψαριού   <i>fish fork</i>	18,2 cm

pack: 12/120

18/10 • 2,5 mm *America*



19.24370	μαχαίρι φαγητού   <i>table knife</i>	21,5 cm
19.24371	πιρούνι φαγητού   <i>table fork</i>	19,5 cm
19.24372	κουτάλι φαγητού   <i>table spoon</i>	19,5 cm
19.24377	μαχαίρι φρούτου   <i>dessert knife</i>	18,9 cm
19.24378	πιρούνι φρούτου   <i>dessert fork</i>	17,1 cm
19.24375	κουτάλι φρούτου   <i>dessert spoon</i>	17,8 cm
19.24376	πιρούνι γλυκού   <i>cake fork</i>	15,9 cm
19.24373	κουτάλι γλυκού   <i>tea/coffee spoon</i>	13,3 cm
19.24374	κουτάλι μόκας   <i>moca spoon</i>	11,6 cm

pack: 12/120

18/10 • 3 mm *Swing*



19.24130	μαχαίρι φαγητού   <i>table knife</i>	22,5 cm
19.24131	πιρούνι φαγητού   <i>table fork</i>	20,9 cm
19.24132	κουτάλι φαγητού   <i>table spoon</i>	20,8 cm
19.24133	μαχαίρι φρούτου   <i>dessert knife</i>	20,5 cm
19.24134	πιρούνι φρούτου   <i>dessert fork</i>	18,7 cm
19.24135	κουτάλι φρούτου   <i>dessert spoon</i>	18,7 cm
19.24137	πιρούνι γλυκού   <i>cake fork</i>	15,4 cm
19.24136	κουτάλι γλυκού   <i>tea/coffee spoon</i>	14,6 cm
19.24138	κουτάλι μόκας   <i>moca spoon</i>	11,8 cm
*19.24139	μαχαίρι ψαριού   <i>fish knife</i>	18,1 cm
*19.24140	πιρούνι ψαριού   <i>fish fork</i>	19,8 cm

## Olivia 18/10 • 3 mm

pack:12/120



19.24170	μαχαίρι φαγητού   <i>table knife</i>	24,5 cm
19.24171	πιρούνι φαγητού   <i>table fork</i>	23 cm
19.24172	κουτάλι φαγητού   <i>table spoon</i>	23 cm
19.24173	μαχαίρι φρούτου   <i>dessert knife</i>	21,4 cm
19.24174	πιρούνι φρούτου   <i>dessert fork</i>	19,7 cm
19.24175	κουτάλι φρούτου   <i>dessert spoon</i>	19,8 cm
19.24177	πιρούνι γλυκού   <i>cake fork</i>	17 cm
19.24176	κουτάλι γλυκού   <i>tea/coffee spoon</i>	16,5 cm
19.24178	κουτάλι μόκας   <i>moca spoon</i>	11 cm
*19.24179	μαχαίρι ψαριού   <i>fish knife</i>	21,8 cm
*19.24180	πιρούνι ψαριού   <i>fish fork</i>	19,7 cm



## Superga 18/10 • 2 mm

pack:12/120



19.24412	μαχαίρι φαγητού   <i>table knife</i>	22 cm
19.24419	μαχαίρι φαγητού   <i>table knife Forged</i>	22,4 cm
19.24411	πιρούνι φαγητού   <i>table fork</i>	19,6 cm
19.24410	κουτάλι φαγητού   <i>table spoon</i>	19,6 cm
19.24417	μαχαίρι φρούτου   <i>dessert knife</i>	19,4 cm
19.24418	πιρούνι φρούτου   <i>dessert fork</i>	17,7 cm
19.24415	κουτάλι φρούτου   <i>dessert spoon</i>	17,8 cm
19.24416	πιρούνι γλυκού   <i>cake fork</i>	15,1 cm
19.24413	κουτάλι γλυκού   <i>tea/coffee spoon</i>	14,1 cm
19.24414	κουτάλι μόκας   <i>moca spoon</i>	11,5 cm





**“Ston  
Wash&Sa**  
vintage collection

## Settecento

18/10 • 3 mm, pack:12

19.26123	μαχαίρι φαγητού   <i>table knife</i>	24 cm
19.26122	πιρούνι φαγητού   <i>table fork</i>	20,9 cm
19.26121	κουτάλι φαγητού   <i>table spoon</i>	20,9 cm
19.26126	μαχαίρι φρούτου   <i>dessert knife</i>	21,5 cm
19.26125	πιρούνι φρούτου   <i>dessert fork</i>	18,6 cm
19.26124	κουτάλι φρούτου   <i>dessert spoon</i>	18,8 cm
19.26127	κουτάλι τσαγιού   <i>tea spoon</i>	14,5 cm

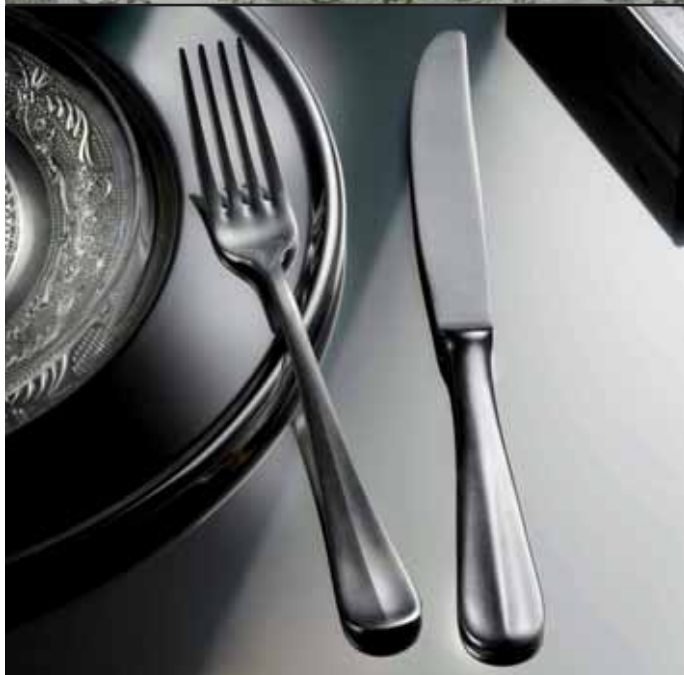

## Baguette

18/10 • 3mm, pack:12

19.26143	μαχαίρι φαγητού   <i>table knife</i>	24,1 cm
19.26142	πιρούνι φαγητού   <i>table fork</i>	20,6 cm
19.26141	κουτάλι φαγητού   <i>table spoon</i>	20,6 cm
19.26146	μαχαίρι φρούτου   <i>dessert knife</i>	22 cm
19.26145	πιρούνι φρούτου   <i>dessert fork</i>	18,5 cm
19.26144	κουτάλι φρούτου   <i>dessert spoon</i>	17,8 cm
19.26147	κουτάλι τσαγιού   <i>tea spoon</i>	14,6 cm



## Stresa

18/10 • 2 mm, pack:12

19.80050	μαχαίρι φαγητού   <i>table knife</i>	22,2 cm
19.80049	πιρούνι φαγητού   <i>table fork</i>	19,6 cm
19.80048	κουτάλι φαγητού   <i>table spoon</i>	19,6 cm
19.80053	μαχαίρι φρούτου   <i>dessert knife</i>	19,5 cm
19.80052	πιρούνι φρούτου   <i>dessert fork</i>	17,7 cm
19.80051	κουτάλι φρούτου   <i>dessert spoon</i>	17,8 cm
19.80054	κουτάλι τσαγιού   <i>tea spoon</i>	14,1 cm

## Sky copper satin 18/10 • 4 mm

pack:12



19.80158	μαχαίρι φαγητού   <i>table knife</i>	22,8 cm
19.80157	πιρούνι φαγητού   <i>table fork</i>	20,2 cm
19.80156	κουτάλι φαγητού   <i>table spoon</i>	20 cm
19.80161	μαχαίρι φρούτου   <i>dessert knife</i>	21 cm
19.80160	πιρούνι φρούτου   <i>dessert fork</i>	18 cm
19.80159	κουτάλι φρούτου   <i>dessert spoon</i>	18 cm
19.80162	κουτάλι καφέ   <i>tea/coffee spoon</i>	14 cm
19.80163	κουτάλι μόκας   <i>moca spoon</i>	11,4 cm

## Sky total black satin 18/10 • 4 mm

pack:12



19.80149	μαχαίρι φαγητού   <i>table knife</i>	22,8 cm
19.80148	πιρούνι φαγητού   <i>table fork</i>	20,2 cm
19.80147	κουτάλι φαγητού   <i>table spoon</i>	20 cm
19.80152	μαχαίρι φρούτου   <i>dessert knife</i>	21 cm
19.80151	πιρούνι φρούτου   <i>dessert fork</i>	18 cm
19.80150	κουτάλι φρούτου   <i>dessert spoon</i>	18 cm
19.80153	κουτάλι καφέ   <i>tea/coffee spoon</i>	14 cm
19.80154	κουτάλι μόκας   <i>moca spoon</i>	11,4 cm

## Sky 18/10 • 4 mm

pack:12



19.80136	μαχαίρι φαγητού   <i>table knife</i>	22,8 cm
19.80135	πιρούνι φαγητού   <i>table fork</i>	20,2 cm
19.80134	κουτάλι φαγητού   <i>table spoon</i>	20 cm
19.80139	μαχαίρι φρούτου   <i>dessert knife</i>	21 cm
19.80138	πιρούνι φρούτου   <i>dessert fork</i>	18 cm
19.80137	κουτάλι φρούτου   <i>dessert spoon</i>	18 cm
19.80140	κουτάλι καφέ   <i>tea/coffee spoon</i>	14 cm
19.80141	κουτάλι μόκας   <i>moca spoon</i>	11,4 cm



pack:12 18/10 • forged *Audrey mystique*



*19.80123	μαχαίρι φαγητού   <i>table knife</i>	23,5 cm
*19.80122	προύνι φαγητού   <i>table fork</i>	21,1 cm
*19.80121	κουτάλι φαγητού   <i>table spoon</i>	21,5 cm
*19.80126	μαχαίρι φρούτου   <i>dessert knife</i>	20 cm
*19.80125	προύνι φρούτου   <i>dessert fork</i>	18 cm
*19.80124	κουτάλι φρούτου   <i>dessert spoon</i>	18 cm
*19.80127	κουτάλι καφέ   <i>tea/coffee spoon</i>	14,6 cm
*19.80128	κουτάλι μόκας   <i>moca spoon</i>	11 cm

pack:12 18/10 • forged *Audrey*



*19.80107	μαχαίρι φαγητού   <i>table knife</i>	23,4 cm
*19.80106	προύνι φαγητού   <i>table fork</i>	21,1 cm
*19.80105	κουτάλι φαγητού   <i>table spoon</i>	21,5 cm
*19.80110	μαχαίρι φρούτου   <i>dessert knife</i>	20 cm
*19.80109	προύνι φρούτου   <i>dessert fork</i>	18 cm
*19.80108	κουτάλι φρούτου   <i>dessert spoon</i>	18 cm
*19.80111	κουτάλι καφέ   <i>tea/coffee spoon</i>	14,6 cm
*19.80112	κουτάλι μόκας   <i>moca spoon</i>	11 cm

pack:12  18/10 • forged *Audrey black*



*19.80184	μαχαίρι φαγητού   <i>table knife</i>	23,5 cm
*19.80183	προύνι φαγητού   <i>table fork</i>	21,1 cm
*19.80182	κουτάλι φαγητού   <i>table spoon</i>	21,5 cm
*19.80187	μαχαίρι φρούτου   <i>dessert knife</i>	20 cm
*19.80186	προύνι φρούτου   <i>dessert fork</i>	18 cm
*19.80185	κουτάλι φρούτου   <i>dessert spoon</i>	18 cm
*19.80188	κουτάλι καφέ   <i>tea/coffee spoon</i>	14,6 cm
*19.80189	κουτάλι μόκας   <i>moca spoon</i>	11 cm

*Audrey oriental set* 18/10



\*19.80119  
chopsticks | *chopsticks*  
24 cm



\*19.80120  
στανι για chopsticks | *chopsticks rest*  
8,4x3,3 | 1,2 cm



Το «Fine Dine» είναι ένα νέο διεθνές brand που αξίζει της προσοχής σας. Η αποστολή του «Fine Dine» είναι να προσφέρει προϊοντικές προτάσεις, ιδέες που να ικανοποιούν με τον καλύτερο δυνατό τρόπο τις καθημερινές αλλά και τις αυριανές απαιτήσεις των χυριών μαζικής εστίασης. Ασχολείται κυρίως με τον τομέα που αφορά γενικά το σερβίρισμα, επιτραπέζιο, μπουφέ, μπαρ κ.λπ. Οι προτάσεις του χαρακτηρίζονται από το δημιουργικό αλλά από ύψος, την συνέπεια στην ποιότητα αλλά και την προσυή τιμή.



«Fine Dine» is a new international brand that deserves your attention. The mission of «Fine Dine» is to offer product propositions, concepts that will satisfy in the best possible way the daily but also the tomorrow's requirements of the food service market. It mainly deals with the food service and food presentation areas, such as table, buffet, bar etc. Its proposals are characterized by the creative but simple style, the consistency in quality and the affordability.



*Garda* 18/10 • 3 mm pack: 12



30.50010	μαχαίρι φαγητού   table knife	23 cm
30.50023	πιρούνι φαγητού   table fork	20,7 cm
30.50022	κουτάλι φαγητού   table spoon	20,4 cm
30.50019	μαχαίρι φρούτου   dessert knife	20 cm
30.50021	πιρούνι φρούτου   dessert fork	18,3 cm
30.50020	κουτάλι φρούτου   dessert spoon	18,2 cm
30.50026	πιρούνι γλυκού   cake fork	15,2 cm
30.50024	κουτάλι τσαγιού   tea/coffee spoon	14,5 cm
30.50025	κουτάλι μόκας   moca spoon	12,1 cm

*Amarone* 18/10 • 4mm pack: 12



30.50001	μαχαίρι φαγητού   table knife	23,7 cm
30.50003	πιρούνι φαγητού   table fork	21,3 cm
30.50002	κουτάλι φαγητού   table spoon	21,1 cm
30.50004	μαχαίρι φρούτου   dessert knife	19 cm
30.50006	πιρούνι φρούτου   dessert fork	18,7 cm
30.50005	κουτάλι φρούτου   dessert spoon	18,4 cm
30.50009	πιρούνι γλυκού   cake fork	15,3 cm
30.50007	κουτάλι τσαγιού   tea/coffee spoon	14,6 cm
30.50008	κουτάλι μόκας   moca spoon	11,9 cm

## - PKS -

Με γνώμονα τη διαχρονικότητα της σχέσης μας με τον πελάτη, αναπτύσσουμε επιτυχείς και μακροχρόνιες συνεργασίες με προμηθευτές του εξωτερικού ώστε να παρέχουμε ολοκληρωμένες και αξιόπιστες σειρές προϊόντων προσαρμοσμένες στις απαιτήσεις τους. Η επιλογή των προϊόντων γίνεται μετά από έρευνα των τάσεων της αγοράς και ενδελεχή έλεγχο με στόχο την προμήθεια προϊόντων στην καλύτερη σχέση ποιότητας/τιμής με διάρκεια και συνέπεια.



Depending on the timelessness of our relationship with the customer, we develop successful and long-term partnerships with suppliers from abroad to provide complete and reliable product ranges tailored to their requirements. Products are selected following market research and continuous control with a view to supplying products in the best relationship quality / price with duration and consistency.



pack: 1/12

18/0 • 5 mm *Cube*



60.39250	μαχαίρι φαγητού   table knife	23,4 cm
60.39251	πιρούνι φαγητού   table fork	21,2 cm
60.39252	κουτάλι φαγητού   table spoon	20,6 cm
60.39253	μαχαίρι φρούτου   dessert knife	20,5 cm
60.39254	πιρούνι φρούτου   dessert fork	18,9 cm
60.39255	κουτάλι φρούτου   dessert spoon	18,4 cm
60.39256	κουτάλι γλυκού   tea/coffee spoon	14,3 cm
60.39257	πιρούνι γλυκού   cake fork	15,6 cm
60.39258	κουταλάκι καφέ   coffee spoon	11,2 cm

pack: 1/12

18/0 • 3 mm *Duke*



60.39410	μαχαίρι φαγητού   table knife	24 cm
60.39412	πιρούνι φαγητού   table fork	20 cm
60.39411	κουτάλι φαγητού   table spoon	20,5 cm
60.39413	μαχαίρι φρούτου   dessert knife	20,7 cm
60.39415	πιρούνι φρούτου   dessert fork	18 cm
60.39414	κουτάλι φρούτου   dessert spoon	18,2 cm
60.39416	κουτάλι τσαγιού   tea/coffee spoon	14,1 cm
60.39417	πιρούνι γλυκού   cake fork	14,3 cm
60.39418	κουτάλι μόκας   moca spoon	11,7 cm

## Harmony 18/0 • 3 mm pack:1/12



60.39380	μαχαίρι φαγητού   <i>table knife</i>	22,9 cm
60.39381	πιρούνι φαγητού   <i>table fork</i>	21 cm
60.39382	κουτάλι φαγητού   <i>table spoon</i>	21 cm
60.39385	μαχαίρι φρούτου   <i>dessert knife</i>	20,2 cm
60.39386	πιρούνι φρούτου   <i>dessert fork</i>	18,7 cm
60.39387	κουτάλι φρούτου   <i>dessert spoon</i>	18,6 cm
60.39383	κουτάλι γλυκού   <i>tea/coffee spoon</i>	13,7 cm
60.39384	πιρούνι γλυκού   <i>cake fork</i>	13,7 cm
60.39388	κουτάλι μόκας   <i>moca spoon</i>	11,7 cm



## Harmony 18/10 • 3 mm pack:1/12

60.39380	μαχαίρι φαγητού   <i>table knife</i>	22,9 cm
60.39390	πιρούνι φαγητού   <i>table fork</i>	21 cm
60.39391	κουτάλι φαγητού   <i>table spoon</i>	21 cm
60.39385	μαχαίρι φρούτου   <i>dessert knife</i>	20,2 cm
60.39392	πιρούνι φρούτου   <i>dessert fork</i>	18,7 cm
60.39393	κουτάλι φρούτου   <i>dessert spoon</i>	18,6 cm
60.39394	κουτάλι γλυκού   <i>tea/coffee spoon</i>	13,7 cm
60.39395	κουτάλι μόκας   <i>moca spoon</i>	11,7 cm

## K-Ψ 18/0 • 2,5 mm pack:1/12



60.39221	μαχαίρι φαγητού   <i>table knife</i>	22,2 cm
60.39222	πιρούνι φαγητού   <i>table fork</i>	19,6 cm
60.39223	κουτάλι φαγητού   <i>table spoon</i>	19,7 cm
60.39225	πιρούνι γλυκού   <i>cake fork</i>	14,5 cm
60.39224	κουτάλι γλυκού   <i>tea/coffee spoon</i>	14,2 cm
60.39226	κουτάλι μόκας   <i>moca spoon</i>	10,1 cm

## K-Φ 18/10 • 2,5 mm pack:1/12



60.39231	μαχαίρι φαγητού   <i>table knife</i>	23,2 cm
60.39232	πιρούνι φαγητού   <i>table fork</i>	20,4 cm
60.39233	κουτάλι φαγητού   <i>table spoon</i>	20,2 cm
60.39235	πιρούνι γλυκού   <i>cake fork</i>	15,7 cm
60.39234	κουτάλι γλυκού   <i>tea/coffee spoon</i>	15,2 cm



pack: 1/12

18/0 • 4 mm *Elegant*



60.39300	μαχαίρι φαγητού   <i>table knife</i>	23,3 cm
60.39301	πιρούνι φαγητού   <i>table fork</i>	20,6 cm
60.39302	κουτάλι φαγητού   <i>table spoon</i>	20,5 cm
60.39303	μαχαίρι φρούτου   <i>dessert knife</i>	20,1 cm
60.39304	πιρούνι φρούτου   <i>dessert fork</i>	17,4 cm
60.39305	κουτάλι φρούτου   <i>dessert spoon</i>	17,4 cm
60.39306	μαχαίρι γλυκού   <i>cake knife</i>	17 cm
60.39307	πιρούνι γλυκού   <i>cake fork</i>	15,5 cm
60.39308	κουτάλι γλυκού   <i>tea/coffee spoon</i>	13,7 cm
60.39309	κουτάλι μόκας   <i>moca spoon</i>	10,3 cm
60.39310	μαχαίρι ψαριού   <i>fish knife</i>	19,8 cm
60.39311	πιρούνι ψαριού   <i>fish fork</i>	18,4 cm
60.39312	μαχαίρι steak   <i>steak knife</i>	22,3 cm
60.39313	κουτάλι γρανίτας   <i>iced tea spoon</i>	22,2 cm

pack: 1/12

18/0 • 2 mm *K-Σ*



60.50003	μαχαίρι φαγητού   <i>table knife</i>	21,3 cm
60.55003	πιρούνι φαγητού   <i>table fork</i>	18,7 cm
60.38003	κουτάλι φαγητού   <i>table spoon</i>	18,6 cm
60.50023	μαχαίρι γλυκού   <i>cake knife</i>	17,4 cm
60.55023	πιρούνι γλυκού   <i>cake fork</i>	15,2 cm
60.38023	κουτάλι γλυκού   <i>tea/coffee spoon</i>	13,6 cm
60.38053	κουτάλι μόκας   <i>moca spoon</i>	11,1 cm
60.38033	κουτάλι γρανίτας   <i>iced tea spoon</i>	20,9 cm

pack: 1/12

18/10 • 4 mm *Elegant*

60.39300	μαχαίρι φαγητού   <i>table knife</i>	23,3 cm
60.39370	πιρούνι φαγητού   <i>table fork</i>	20,6 cm
60.39371	κουτάλι φαγητού   <i>table spoon</i>	20,5 cm
60.39303	μαχαίρι φρούτου   <i>dessert knife</i>	20,1 cm
60.39372	πιρούνι φρούτου   <i>dessert fork</i>	17,4 cm
60.39373	κουτάλι φρούτου   <i>dessert spoon</i>	17,4 cm
60.39306	μαχαίρι γλυκού   <i>cake knife</i>	17 cm
60.39374	πιρούνι γλυκού   <i>cake fork</i>	15,5 cm
60.39375	κουτάλι γλυκού   <i>tea/coffee spoon</i>	13,7 cm

*K-Y* 18/10 • 2,5 mm

pack:1/12



60.39170	μαχαίρι φαγητού   <i>table knife</i>	23 cm
60.39171	πιρούνι φαγητού   <i>table fork</i>	19,4 cm
60.39172	κουτάλι φαγητού   <i>table spoon</i>	19,4 cm
60.39174	πιρούνι γλυκού   <i>cake fork</i>	14,7 cm
60.39173	κουτάλι γλυκού   <i>tea/coffee spoon</i>	13,8 cm

*K-A* 18/0 • 2,5 mm

pack:1/12



60.50011	μαχαίρι φαγητού   <i>table knife</i>	22,7 cm
60.55085	πιρούνι φαγητού   <i>table fork</i>	19,3 cm
60.55086	κουτάλι φαγητού   <i>table spoon</i>	20,3 cm
60.55087	πιρούνι γλυκού   <i>cake fork</i>	11,4 cm
60.55088	κουτάλι γλυκού   <i>tea/coffee spoon</i>	13,6 cm
60.55089	κουτάλι μόκας   <i>moca spoon</i>	10,7 cm

*Easy* 18/0 • 2 mm

pack:1/12



60.39400	μαχαίρι φαγητού   <i>table knife</i>	21,9 cm
60.39401	πιρούνι φαγητού   <i>table fork</i>	18,7 cm
60.39402	κουτάλι φαγητού   <i>table spoon</i>	18,8 cm
60.39403	κουτάλι γλυκού   <i>tea/coffee spoon</i>	14 cm
60.39404	πιρούνι γλυκού   <i>cake fork</i>	14,9 cm
60.39405	κουτάλι καφέ   <i>coffee spoon</i>	11,1 cm



## steak knives

30.10194 μαχαίρι steak «Taurus» με ξύλινη λαβή,  
13 cm / 25,2 cm  
pack: 6

30.10195 πιρούνι steak «Taurus» με ξύλινη λαβή,  
13 cm / 25,2 cm  
pack: 6

HEPP



47.30401 μαχαίρι steak «Αντίμα»,  
10,2 cm / 24,2 cm  
pack: 1/6

ICFL



47.30405 μαχαίρι steak με ξύλινη λαβή, οδοντωτό,  
11 cm / 23 cm  
pack: 1/6

ICFL



47.30406 μαχαίρι steak με ξύλινη λαβή, ίσια λάμα  
11 cm / 23,3 cm  
pack: 1/6

ICFL



47.30404 μαχαίρι steak με ξύλινη λαβή, οδοντωτό,  
Vintage λάμα, 12 cm / 23,2 cm  
pack: 1/6

ICFL



47.30400 μαχαίρι steak «Premium» με ξύλινη λαβή,  
13 cm / 25,5 cm  
pack: 6

ICFL



19.39017 μαχαίρι steak «P. Wood»,  
12,3 cm / 24,2 cm  
pack: 1

PINTEX



19.39016 μαχαίρι steak «P. Wood»,  
11,1 cm / 21,4 cm  
pack: 1

PINTEX



34.60117 μαχαίρι steak «Premium» οδοντωτό,  
11,5 cm / 22,5 cm  
pack: 12

GenWare



30.50027 μαχαίρι steak | *steak knife*, 24,5 cm  
pack: 12

FineDine



30.50029 πιρούνι steak | *steak fork*, 21 cm  
pack: 12

FineDine



30.50028 μαχαίρι steak | *steak knife*, 26 cm  
pack: 12

FineDine



30.40358 σετ 6 μαχαίρια steak,  
25 cm  
pack: 1

HENDI



30.40251 σετ 6 μαχαίρια steak,  
21,5 cm  
pack: 1

HENDI



30.40250 σετ 6 πιρούνια steak,  
20 cm  
pack: 1

HENDI



34.60275 mini μπαλτάς steak, 19,2x7,5 cm  
pack: 12

GenWare





**96.33002** μαχαίρι steak μυτερό, οδοντωτό  
21199/764 με ξύλινη λαβή rosewood  
12,7 cm / 20,3 cm  
**POLYWOOD** pack: 12



**96.33003** μαχαίρι steak μυτερό, λείο  
21137/475 με ξύλινη λαβή rosewood  
11,4 cm / 20,9 cm  
**POLYWOOD** pack: 12



**96.33001** μαχαίρι steak στρογγυλό, μισό οδοντωτό - μισό λείο  
21101/474 με ξύλινη λαβή rosewood  
10,5 cm / 20,3 cm  
**POLYWOOD** pack: 12



**96.33028** μαχαίρι steak οδοντωτό, με μαύρη λαβή  
23854/105 11,5 cm / 22 cm  
pack: 12



**96.33029** μαχαίρι steak οδοντωτό, με μαύρη fiberglass λαβή  
24004/005 11,6 cm / 22,3 cm  
pack: 12



**96.33005** πιρούνι φαγητού, με ξύλινη λαβή rosewood  
21198/718 9,6 cm / 19,4 cm  
pack: 12



**96.33006** κουτάλι φαγητού, με ξύλινη λαβή rosewood  
21103/470 9,6 cm / 19,4 cm  
pack: 12



**96.33007** πιρούνι επιδορπίου, με ξύλινη λαβή rosewood  
21105/470 8,7 cm / 17,2 cm  
pack: 12



**96.33008** κουτάλι επιδορπίου, με ξύλινη λαβή rosewood  
21106/470 8,5 cm / 17 cm  
pack: 12



**96.33004** μαχαίρι λαχανικών, λείο  
21121/173 με ξύλινη λαβή rosewood,  
9,1 cm / 19,6 cm  
pack: 12





96.33032 μαχαίρι steak «Jumbo», οδοντωτό  
29810/143 με ξύλινη καφέ-μπεζ λαβή  
11,8 cm / 23,8 cm

**CHURRASCO** pack: 12



96.33010 μαχαίρι steak «Jumbo», οδοντωτό  
21116/075 με ξύλινη λαβή rosewood  
12 cm / 25 cm

**CHURRASCO** pack: 12



96.33022 μαχαίρι steak, οδοντωτό  
21416/075 με ξύλινη καφέ λαβή  
12,7 cm / 24,6 cm

**CHURRASCO** pack: 12



96.33020 μαχαίρι steak, λείο,  
21414/075 με ξύλινη λαβή rosewood  
11,7 cm / 23,6 cm

**CHURRASCO** pack: 12



96.33021 μαχαίρι steak, λείο  
21414/095 με ξύλινη καφέ λαβή  
11,7 cm / 23,6 cm

**CHURRASCO** pack: 12



96.33024 μαχαίρι steak, με ξύλινη καφέ λαβή,  
29810/023 10,2 cm / 22,6 cm

**CHURRASCO** pack: 12



96.33023 πιρούνι steak, με ξύλινη καφέ λαβή,  
29810/159 22,1 cm

**CHURRASCO** pack: 12



96.33009 μαχαίρι steak στρογγυλό οδοντωτό,  
29810/198 με ξύλινη καφέ λαβή  
11,5 cm / 22,4 cm

**POLYWOOD** pack: 12





<i>HEPP buffet-service</i> .....	212-217
<i>ζεστός μπουφές: chafing dish, σουπιέρες, εστίες θερμότητας, μπεν μαρί, σκεύη μπουφέ, carving stations, δοχεία σάβιτσας</i> .....	218-223
<i>FRILICH buffet</i> .....	224-231
<i>buffet protection</i> .....	232-233
<i>κρύος μπουφές: single portioning, βιρίνες/stand κρύων διανεμητές χυμών / γάδακτος / musli / μαρμελάδας, ποτήρια χυμού</i> .....	234-239
<i>σκεύη παρουσίασης inox: δίσκοι, παιτέδες</i> .....	240
<i>παρουσίαση ψωμιού</i> .....	241-245
<i>service stands</i> .....	246-249
<i>σκεύη μεδαμίνης: μπουδάκια, μπού, δίσκοι, παιτέδες, δοχεία GN, amuse-bouche,</i> .....	250-269
<i>amuse-bouche: μεδαμίνης, γνάθινα, κουτάδια</i> .....	270-273
<i>δίσκοι μεδαμίνης GN</i> .....	274-275
<i>παιτέδες με πόδι: γνάθινες, μεδαμίνης, καπάκια «καμπάνα»</i> .....	276-277
<i>σιανι για μπού-παιτέδες-πιάτα</i> .....	278-279
<i>γνάθινα σκεύη: σαδαπιέρες, μπουδάκια, σουπιά, καμπάνες πιάτων, ποτήρια παρουσίασης, δοχεία αποθήκευσης</i> .....	280-282
<i>σκεύη πορσελάνης- stoneware: παιτέδες, δίσκοι, σαδαπιέρες, μπού, δοχεία GN</i> .....	283-285
<i>πιρούνες, κουτάδες, σπάτουδες, λαβίδες</i> .....	286-289
<i>πλάσι φυσικής πέτρας</i> .....	290-291
<i>ξύθινα πλάσι</i> .....	292-296
<i>σκεύη σερβιρίσματος inox - γαλβανίζε - copper - μαντεμένα - πυρίμαχα, εμαγιέ, λαδόκοδες</i> .....	297-309
<i>μύθι</i> .....	310-311
<i>λαδόξυδα - φιάδες λαδιού</i> .....	312-313
<i>οργάνωση τραπεζιού σαδισιέρες, τριέρες, stand αριθμών, ανθοδοχεία, χαριτοπεποιηθήκες, κηροπήγια</i> .....	314-316
<i>σουπιά</i> .....	317
<i>ψωμιέρες</i> .....	318-321
<i>δίσκοι σερβιρίσματος</i> .....	322-325
<i>τρόδει σερβιρίσματος</i> .....	326-329



# *buffet - service*





# «Induction Plus»

Η ποιοτικότερη, μοντέρνα εκδοχή των chafing dish από την HEPP! 3 διαφορετικά μεγέθη (GN 1/1, GN 2/3 και στρογγυλό) και 2 διαφορετικά σχέδια χερουλιών (Excellent & Arte) για να επιλέξετε αυτά που ταιριάζουν απόλυτα με το χώρο σας. Κατάλληλα για επαγωγικές και απλές ηλεκτρικές εστίες, ή ακόμα και χρήση με καύσιμη ύλη (εφόσον τοποθετηθούν στις αντίστοιχες βάσεις τους). Τα καπάκια είναι αφαιρούμενα για εύκολο πλύσιμο, ενώ οι μηχανισμοί φρένων αντικαθίστανται όταν φθαρούν, διατηρώντας τα σκεύη σας σαν καινούργια!

Indulge the senses at all levels. CD INDUCTION PLUS EXCELLENT, GN 1/1 inductive, for inserts up to depth 10 cm/4 in., glass lid with break removable, electrically and sterno heating possible, bow handle, stainless steel polished, glass.

**30.10069** 57.0002.6040  
chafing dish GN 2/3  
37x45 cm | 19 cm  
pack: 1



**30.10068** 57.0001.6040  
chafing dish στρογγυλό  
39 cm | 19 cm  
pack: 1



**30.10070** 57.0003.6040  
chafing dish GN 1/1  
58x47 cm | 19 cm  
pack: 1

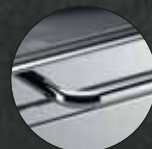

«Excellent»

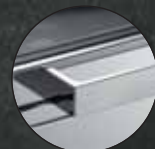

«Arte»

**30.10073** 57.0016.6040  
βάση GN 1/1  
54x37 cm | 17 cm  
pack: 1



**30.10072** 57.0006.6040  
βάση GN 2/3  
37x40 cm | 17 cm  
pack: 1

**30.10071** 57.0005.6040  
βάση στρογγυλή  
39 cm | 17 cm  
pack: 1

## δοχεία πορσελάνης porcelain inserts

**\*30.10908** GN 1/2  
50.8366.0120 26,5x32,5 cm | 6,5 cm  
3,3 ltr  
pack: 1



**\*30.10910** GN 2/3  
50.8366.0230 35,4x32,5 cm | 6,5 cm  
4,65 ltr  
pack: 1



**\*30.10907** GN 1/1  
50.8366.0110 53x32,5 cm | 6,5 cm  
7,3 ltr  
pack: 1



**\*30.10239** στρογγυλό round  
60.8874.3000 30 cm | 7 cm  
3 ltr  
pack: 1



**\*30.10240** στρογγυλό με κόρισμα  
60.8879.3000 2-part round  
30 cm | 7 cm  
2,6 ltr  
pack: 1



## αξεσουάρ chafing dishes

**\*30.10074** ράφι για τοποθέτηση  
57.0033.6040 λαβίδας ή κουτάλας,  
inox 18/10  
rack for utensils  
28x12 cm | 7 cm  
pack: 1



**\*30.10075** μπόλακι πορσελάνης  
57.0034.9800 με εγκοπές για λαβίδες  
σερβιρίσματος  
porcelain bowl for rack  
for utensils  
21x9 cm | 3 cm  
pack: 1



## ηλεκτρικές αντιστάσεις | heating elements

**\*30.10163** για GN 1/1  
57.0067.9990 for GN 1/1  
25x20 cm  
pack: 1

**\*30.10076** για GN 2/3 και στρογγυλό  
57.0024.9990 for GN 2/3 and round  
25x20 cm  
pack: 1



# «Excellent»

διανεμητές χυμού  
juice dispensers



διανεμητής γάλακτος με ρυθμιζόμενο ύψος, βρυσάκι non-drip και ψύξη με στήλη πάγου (προαιρετικά)  
milk dispenser individually height adjustable, clear labelling, non dripping hygienic spout, cooling with ice tube (accessory)

\*30.10144 6,5 lt, (5,5 lt με την στήλη)  
57.0118.6040 (5,5 lt with the ice tube)  
30,5 cm | 52 cm  
pack: 1



διανεμητής χυμού με ρυθμιζόμενο ύψος, βρυσάκι non-drip και ψύξη με στήλη πάγου (προαιρετικά)  
juice dispenser individually height adjustable, clear labelling, non dripping hygienic spout, cooling with ice tube (accessory)

\*30.10059 6,5 lt, (5,5 lt με την στήλη)  
57.0116.6040 (5,5 lt with the ice tube)  
30,5 cm | 52 cm  
pack: 1

\*30.10061 στήλη πάγου | ice tube  
57.0120.6040 1 lt, (27 cm)  
pack: 1



διανεμητές δημητριακών  
cereal dispensers



διανεμητής δημητριακών, τριπλός με δοχεία 3,6 lt  
cereal dispenser in-line with 3 containers 3,6 lt

\*30.10164 3x3,6 lt  
57.0123.6040 39x25 cm | 59,7 cm  
pack: 1



διανεμητής δημητριακών, τριπλός περιστρεφόμενος, με δοχεία 3,5 lt  
cereal dispenser turnable, with 3 containers 3,6 lt

\*30.10062 3x3,5 lt  
57.0122.6040 35,7 cm | 59 cm  
pack: 1



# «Sequence»



Εξοπδίζονται με ταψί πορσελάνης και με επιφάνειες μελαμίνης με υφή ξύδου και corian.

Platters in melamine and corian, as well as porcelain bowls available in various sizes and volumes. Frames slot seamlessly into stainless steel frames from size XS to GN 1/1.



5 σχήματα και σε 3 διαφορετικά ύψη. Όλα σε inox.  
Stainless steel frames are available in many sizes and heights for various applications.

Τα ίδια inox 18/10 πλαίσια διαμορφώνουν 4 stands, 2 ή 3 επίπεδων.

The four new stars among stands in different sizes and shapes.



Λεκάνες πάγου ή ψυκτικών στοιχείων.

Ice bath. Cooled using ice cubes or cooling packs.

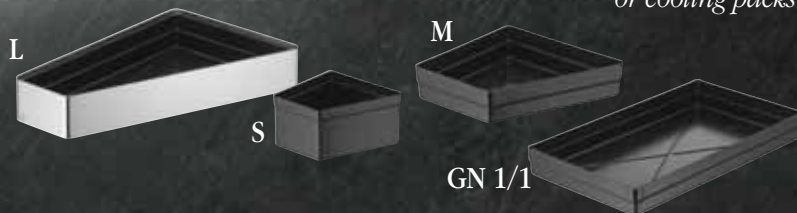

Μποθ πορσελάνης σε διάφορα μεγέθη.  
Porcelain bowls in various sizes

XS

S

M

L

GN 1/1





# a joy for the eyes «Sequence»

The tasteful art of service has a new name: Sequence – the innovative buffet concept with unusual lines that is beautifully simple to use. With this new about 45-piece collection, HEPP is setting new standards in culinary presentation. The system is available in various dimensions, asymmetric forms, and material combinations, such as wood, porcelain, stainless steel, fabric, corian and plastic – this array of harmoniously matched pieces means your creativity knows no bounds. An exquisite highlight for your guests' Boredom is a thing of the past – today belongs to Sequence.

Ένα πρωτοποριακό concept μπουφέ με ασυνήθιστες γραμμές, όμορφο και εύκολο στην χρήση. Διαθέτει 45 νεοσχεδιασμένα κομμάτια θέιονιας νέα σιάνταρνι στην παρουσίαση του μπουφέ. Υδρικά όπως μεδαμίνη, ποροεδάνη, ύφασμα, corian, πλάστικό και inox 18/10, σε ασύμμετρες φόρμες και αιέδειωτους συνδυασμούς, βρίσκονται δίπλα-δίπλα που σημαίνει ότι δεν υπάρχουν όρια στις δημιουργίες σας.



Stands σε 2 μεγέθη με επιφάνεια μεδαμίνης ή corian.

Melamine or corian platforms available in two sizes to show off your culinary delights.



Πάνινες ψυμιέρες για τα τριγωνικά inox πλαίσια.

Fabric inserts (bread baskets) for the inox frames.

M

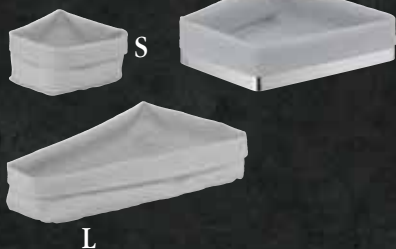

XS

S

M

L

GN 1/1



Επιφάνειες μεδαμίνης και corian.

Platters in melamine and corian.



Εύδινος δίσκος κοπής για το πλάισιο GN 1/1

Oak cutting board GN 1/1



Τριγωνικά πλαίσια inox με ύψος 4 ή 7 ή 10 cm

Frames inox available in 4 ή 7 ή 10 cm height



**\*30.10156** σετ λαδόξυδο st.steel  
12.4141.0000  
*vinegar and oil stand, st.steel*  
21 cm  
pack: 1



**\*30.10169** αλατιέρα st.steel  
60.5655.0900  
*salt shaker st.steel, 9 cm*  
pack: 1

**\*30.10168** πιπεριέρα st.steel  
60.5656.0900  
*pepper shaker st.steel, 9 cm*  
pack: 1

**\*30.10153** τυριέρα, st.steel  
12.2280.0000  
*με γυάλινο μπολ  
cheese bowl, st.steel*  
8,1 cm  
pack: 1



**\*30.10155** σετ αλατοπίππερο st.steel  
12.4130.0000  
*salt and pepper stand st.steel*  
14,2 cm  
pack: 1



**\*30.10167** βουτυριέρα 4 τμημάτων  
60.5426.0000  
*butter dish, 4-part, st.steel*  
6,9 cm | 14,6 cm  
pack: 1

**30.10173** ανπνεμικό κηροπήγιο  
57.0097.6040  
*για ρεσό, inox/γυαλί  
wind light, metal/ glass*  
9,9 cm | 10,1 cm  
pack: 1



**\*30.10487** 60.9194.0000  
*μαχαίρι χαβιαριού από φίλντισι  
caviar knife, nacre*  
13,7 cm  
pack: 1



**\*30.10488** 60.9195.0000  
*κουτάλι χαβιαριού από φίλντισι  
caviar spoon, nacre*  
12,7 cm  
pack: 1



*σκεύος για χαβιάρι inox  
με γυάλινο μπολ 3 cl  
chillcup for caviar inox,  
with glass bowl 3 cl*

**\*30.10170** 12,7 cm | 7,9 cm  
12.2292.0000 pack: 1



*σκεύος για γαρίδες inox  
με γυάλινο μπολ 15 cl  
chillcup for scampis inox,  
with glass bowl 15 cl*

**\*30.10911** 12,9 cm | 11,3 cm  
12.2294.0000 pack: 1

«Fleur» stands μεταλλικά αντιολισθητικά στάντ για δίσκους και μπολ  
*metal buffet stand with black anti-slide coating*



**30.10063** ύψος | height: 9,8 cm  
57.0035.6040 pack: 1



**30.10064** ύψος | height: 13,6 cm  
57.0036.6040 pack: 1



**30.10065** ύψος | height: 21 cm  
57.0037.6040 pack: 1

\*30.10160 12.4868.1600  
stand γλυκών | *pastry stand*  
16,2 cm | 9 cm  
pack: 1



\*30.10149 12.2243.4230  
εταζέρα 3 επιπέδων  
*3-part etagere*  
43 cm | 62,2 cm  
pack: 1



stand γλυκών 2 επιπέδων  
*2-part pastry stand*

\*30.10151 16 cm | 22,3 cm  
12.2269.1620 pack: 1

\*30.10152 21,5 cm | 22,4 cm  
12.2269.2120 pack: 1

δίσκος inox 18/10  
*serving tray inox 18/10*

\*30.10158 42,5 cm  
12.4860.4200 pack: 1

\*30.10159 50 cm  
12.4860.5000 pack: 1

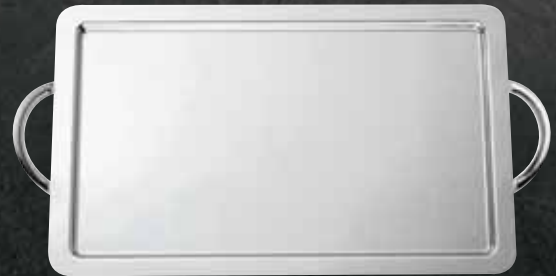

\*30.10157 12.4858.6500  
δίσκος inox 18/10  
*serving tray inox 18/10*  
65x53 cm  
pack: 1





## «CBS Advantage» chafing dish

Spring

διατίθονται και με βάση για χρήση με ατομικό induction ή καύσιμη ύλη  
also available with inox base for round induction unit



\*30.20073 chafing dish, induction, με γυάλινο καπάκι with glass lid inox, GN 1/1 57,5x47,5 cm | 16 cm pack: 1



\*30.20074 chafing dish, induction, με γυάλινο καπάκι with glass lid inox, GN 2/3 48x40 cm | 16 cm pack: 1



\*30.20059 chafing dish, induction, με γυάλινο καπάκι with glass lid inox, για ταψιά 30 cm 38,5 cm | 16 cm pack: 1

## «Rondo» roll-top built-in chafing dish

Spring

διατίθονται και με επίχρυσες λαβές optional gold pated handles



\*30.20017 built-in chafing dish, inox, GN 1/1, 9,5/14 lt 66x48 cm | 23 cm pack: 1



\*30.20003 built-in chafing dish inox, 4,6 lt 46 cm pack: 1

\*30.20020 built-in chafing dish inox, 8 lt 56 cm pack: 1

## ταψιά για chafing dish | insert for chafing dishes

Spring

ταψιά πορσελάνης για chafing dish insert for chafing dishes



\*30.20008 30 cm | 2,2 lt pack: 1

\*30.20032 40 cm | 5,5 lt pack: 1

Spring

με χώρισμα | with divider



\*30.20062 30 cm - 2 lt pack: 1

\*30.20007 40 cm - 6 lt pack: 1

## «ECO» chafing dish



chafing dish GN 1/1, inox σιλιπνό με δοχείο inox 6,5 cm, βάσεις για καυστικά και στήριγμα για το καπάκι high-gloss polished lid and lid stand, including fuel holders and stainless steel food pan 65 mm deep



30.41135 chafing dish, GN 1/1, 9 lt 60x38,8 cm | 29,5 cm pack: 1



30.40541 chafing dish GN 1/2, inox σιλιπνό με δοχείο inox 6,5 cm, βάσεις για καυστικά και στήριγμα για το καπάκι high-gloss polished lid and lid stand, including fuel holders and stainless steel food pan 65 mm deep 4,5 lt - 38,5x29,5 cm | 31 cm pack: 1

## αξεσουάρ | accessories



\*30.40326 καύσιμη ύλη, αιθανόλη fuel gel ethanol, 200 gr (+/-3 h) pack: 1/72



53.40000 καύσιμη ύλη, μεθανόλη fuel gel, methanol 200 gr (+/-3 h) pack: 1



53.40001 καύσιμη ύλη μεθανόλη fuel gel, methanol 4 Kgr pack: 4

## διανεμητές καφέ | coffee dispensers

APS



«Happy Hour», mirror polished διανεμητής καφέ, με 1 καμινέτο, (δέχεται ηλεκτρ. αντίσταση) coffee dispenser, with 1 burner (optional instalation for electric heating element)

\*27.11672 10,5 lt 31x33,5 cm | 54,5 cm pack: 1

\*27.12287 ηλεκτρική αντίσταση heating element 21x20 cm (220 V / 500 W) pack: 1

## soup station



\*30.20052 soup station, 10 lt με καύσιμη ύλη ή ηλεκτρική αντίσταση works with fuel or electric heating element (30.2005) 37 cm | 39 cm pack: 1

## «Globe»

APS

«Globe» για ιδανική κατανομή θερμότητας  
Με αποσπώμενο υδραυλικό καπάκι και πάτο οάντουιτς.  
Για εστίες induction ή καύσιμη ύλη.  
Παραδίδονται με τη βάση τους.

«Globe». Optimum heat distribution.

For induction units or burn gel fuel. Available with their stands.

Supporting frame, removable hydraulic cover and sandwich base.



- \*27.12394 chafing dish, GN 1/1  
inox καπάκι | inox cover  
59x43,5 cm | 34 cm  
pack: 1
- \*27.12404 chafing dish, GN 1/1  
γυάλινο καπάκι | glass cover  
59x43,5 cm | 34 cm  
pack: 1
- 27.12296 πλαίσιο στήριξης  
induction |  
frame for induction plate  
pack: 1



- \*27.12483 chafing dish, GN 2/3  
inox καπάκι | inox cover  
4x41 cm | 34 cm  
pack: 1
- \*27.12484 chafing dish, GN 2/3  
γυάλινο καπάκι | glass cover  
4x41 cm | 34 cm  
pack: 1
- 27.12291 πλαίσιο στήριξης  
induction |  
frame for induction plate  
pack: 1



- \*27.12393 chafing dish, 6 lt  
inox καπάκι | inox cover  
35,5 cm  
pack: 1
- \*27.12403 chafing dish, 6 lt  
γυάλινο καπάκι | glass cover  
35,5 cm  
pack: 1
- \*27.12291 πλαίσιο στήριξης  
induction |  
frame for induction plate  
pack: 1



- σουπιέρα με inox καπάκι, 10 lt  
soup bowl with inox cover, 10 lt
- 27.12398 με βάση | with stand  
48 cm | 45 cm  
pack: 1
- 27.12399 χωρίς βάση | without stand  
48 cm | 32 cm  
pack: 1
- \*27.12291 πλαίσιο στήριξης  
induction |  
frame for induction plate  
pack: 1
- \*27.12396 βάση στήριξης με  
υποδοχή καμινέτων  
support frame for burners  
pack: 1

## chafing dish «Easy Induction»

APS



«Easy Induction» γυάλινο παράθυρο  
και πάτο οάντουιτς.  
Για εστίες induction

«Easy Induction» with glass lid and  
sandwich base. For induction units.

- \*27.12322 chafing dish, 9 lt  
GN 1/1 - 6,5 cm  
60x42 cm | 30 cm  
pack: 1

- \*27.12323 chafing dish, 5,5 lt  
GN 2/3 - 6,5 cm  
42x41 cm | 30 cm  
pack: 1

- \*27.12324 chafing dish, 6 lt  
46x50 cm | 30 cm  
pack: 1

- \*27.12325 chafing dish /σουπιέρα  
chafing dish - soup bowl  
11 lt  
48x42 cm | 39 cm  
pack: 1

## «Elite» chafing dish

chafing dish με roll-top καπάκι με άνοιγμα 180°,  
δοχείο GN 1/1 - 6,5 cm και 2 βάσεις καυστικών  
για καύσιμη ύλη ή ηλεκτρική αντίσταση  
polished, rolltop cover adjustable at 90° and 180°,  
foodpan GN 1/1 6,5 cm deep, waterpan and 2 burner holders



- \*27.12350 chafing dish, inox  
GN 1/1 - 6,5 cm  
67x47 cm | 45 cm  
pack: 1

APS

## ταψιά για chafing dish | insert for chafing dishes

APS



ταψιά πορσελάνης για chafing dish  
insert for chafing dishes

- \*27.82210 39 cm | 6 cm (4,3 lt)  
pack: 1



με χώρισμα | with divider

- \*27.82215 39 cm | 6 cm (2x2 lt)  
pack: 1

εστίες θερμότητας | electric courses



\*30.20046  
induction, built-in  
36x36 cm | 8,5 cm  
230 V – 2.500W  
pack: 1



\*30.20025  
induction, built-in  
touch or remote control  
36x36 cm | 8,5 cm  
230 V – 2.500W  
pack: 1



30.42105  
induction built-in  
35x35 cm | 8 cm  
60–240°C – 1.000W  
pack: 1



30.41327  
induction built-in  
for chafing dishes  
24,5 cm, 800W  
pack: 1



\*30.20060  
induction built-in διατήρησης  
induction built-in hot plate  
80x38 cm | 11 cm, 3.500W  
pack: 1



\*30.20051 θερμαινόμενο ηλεκτρικό σουπλά  
electric keep warm plate  
53,5x33x5 cm | 3,5 cm, 350W  
pack: 1



30.41752 εστία θέρμανσης  
239384  
induction «black line»  
induction hot plate  
45,5x33,3 cm | 6,2 cm  
1.000W (40–100°C)  
pack: 1

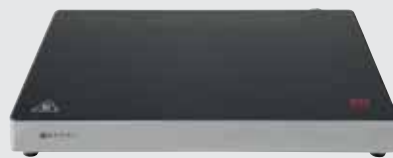

30.41136 εστία θέρμανσης  
209523  
induction «display line»  
induction hot plate  
45,5x33,3 cm | 6,2 cm  
1.000W (40–100°C)  
pack: 1



ρυθμιζόμενες ηλεκτρικές αντιστάσεις  
adjustable electric heating elements

30.20004 chafing dish GN 1/1  
& 56 cm, 800W  
pack: 1

30.20005 chafing dish 46 cm  
500W  
pack: 1



\*30.20077  
σετ φοντού «Culinox»  
set fondue  
inox copper, 18 cm  
pack: 1

\*30.20078  
σετ φοντού inox  
set fondue inox  
2 lt, 18 cm  
pack: 1

\*30.20079  
σετ 6 πιρουνάκια  
set 6 fondue forks,  
26 cm  
pack: 1



\*30.20064 χύτρα με καπάκι  
1554.06.24 deep pot with lid, 24 cm  
pack: 1

\*30.20095 δοχείο πορσελ., 1,5 lt  
5495466024 porcelain insert, 24 cm  
pack: 1

«Culinox» chafing dish copper



\*30.20088  
στάντ για καπάκια  
stand for lids  
pack: 1



\*30.20067 χύτρα με καπάκι  
1554.06.20 deep pot with lid, 20 cm  
pack: 1

\*30.20094 δοχείο πορσελ., 1 lt  
5495466020 porcelain insert, 20 cm  
pack: 1





## βάσεις επαγωγικών εστιών

δεν περιλαμβάνονται οι επαγωγικές εστίες

63.94009  
ξύλινη βάση φυσικό  
36x36 cm | 13,5 cm  
pack: 1



63.94011  
ξύλινη βάση wenge  
36x36 cm | 13,5 cm  
pack: 1



63.94010  
ξύλινη βάση φυσικό  
36x36 cm | 9,5 cm  
pack: 1



63.94012  
ξύλινη βάση wenge  
36x36 cm | 9,5 cm  
pack: 1

## «Hot Buffet»

27.12270 σταθμός induction,  
σετ 4 τεμαχίων:

1 επαγωγική εστία ρυθμιζόμενη  
(24 cm, 900 W)

1 μεταλλική βάση, μαύρη,  
1 πλαίσιο από ξύλο καρυδιάς και  
1 πλαίσιο από ανοξείδωτο ατσάλι,  
induction station, 4 pieces set  
4 piece set:

1 induction hotplate with regulator  
(24 cm, 900 W),

1 stand metal black,

1 element made of walnut wood and  
1 stainless steel frame,

37x35,5 cm | 19 cm

pack: 1

για το σταντ  
«Flexible»  
ανατρέξτε...

σελίδα 233  
BUFFET  
- SERVICE



## μπεν μαρί ανοξείδωτα | inox bain mari induction



27.12335

μπεν μαρί χάλκινο/copper, 4 lt  
30,5 cm | 17,5 cm

pack: 1

APS



\*30.50030

832974

μπεν μαρί κόκκινο | red  
4,5 lt

42x36,5 cm | 18,5 cm

pack: 1

FineDine



27.12338

μπεν μαρί μαύρο, 4 lt  
30,5 cm | 17,5 cm

pack: 1

APS



\*30.50032

832998

μπεν μαρί μπλε | blue,  
4,5 lt

42x36,5 cm | 18,5 cm

pack: 1



27.12329

ανταλλακτικό ταψί  
replacement foodpan, 4 lt

30,5 cm | 8 cm

pack: 1



\*30.50031

832981

μπεν μαρί κίτρινο | yellow  
4,5 lt

42x36,5 cm | 18,5 cm

pack: 1



μαντεμένα σκεύη *induction* | *cast iron dishes*

μπλε πετρόλ | *blue petrol*

νέο προϊόν

Silver



κασσαρόλα μαντεμένα μπλε-πετρόλ  
*cast iron cooking pots*

53.10044 24 cm (4 lt)  
pack: 1

53.10043 28 cm (6 lt)  
pack: 1

Silver



κασσαρόλα μαντεμένα ρηχή  
*cast iron cooking pots shallow*

53.10041 24 cm (2,5 lt)  
pack: 1

53.10040 28 cm (3,4 lt)  
pack: 1

Silver



κασσαρόλα μαντεμένα οβάλ  
*cast iron cooking pots oval*

53.10042 23x30 cm (5 lt)  
pack: 1



53.10045 μαντεμένο ταψί  
*cast iron pan*  
26x40,2 cm  
pack: 1

γκρι | *grey*

νέο προϊόν

Silver



κασσαρόλα μαντεμένα γκρι  
*cast iron cooking pots*

53.10037 24 cm (4 lt)  
pack: 1

53.10038 28 cm (6 lt)  
pack: 1

Silver



κασσαρόλα μαντεμένα ρηχή γκρι  
*cast iron cooking pots shallow*

53.10035 24 cm (2,5 lt)  
pack: 1

53.10034 28 cm (3,4 lt)  
pack: 1

Silver



κασσαρόλα μαντεμένα οβάλ γκρι  
*cast iron cooking pots oval*

53.10036 23x30 cm (5 lt)  
pack: 1

Silver



53.10039 μαντεμένο ταψί γκρι  
*cast iron pan*  
26x40,2 cm  
pack: 1

ξύλινες λαβές-βάσεις για καπάκι μαντεμένων σκευών

63.94013

φυσικό  
pack: 1



νέο προϊόν

63.94014

wenge  
pack: 1



νέο προϊόν



σκεύη αλουμινίου | *forged aluminium utensils*  
«Serie Pro induction»



χύτρα ρηχή με γυάλινο καπάκι  
*low casserole with glass lid*

19.70353 24 cm | 6,8 cm  
pack: 1

19.70354 28 cm | 7,3 cm  
pack: 1

19.70355 32 cm | 7,6 cm  
pack: 1

19.70356 36 cm | 8,5 cm  
pack: 1

19.70357 40 cm | 8,8 cm  
pack: 1



χύτρα βαθιά με γυάλινο καπάκι  
*deep casserole with glass lid*

19.70350 20 cm | 9,8 cm  
pack: 1

19.70351 24 cm | 10,8 cm  
pack: 1

19.70352 28 cm | 12,2 cm  
pack: 1



σκεύη χυτού αλουμινίου | *die-cast aluminium*

PINTEINOX

«Tradition pro induction»



χύτρα βαθιά με καπάκι  
*deep casserole with lid*

19.80165 20 cm | 9,8 cm  
pack: 1

19.80166 24 cm | 10,8 cm  
pack: 1

19.80167 28 cm | 12,2 cm  
pack: 1



Το μαντέμι είναι γνωστό για το καταπληκτικό του μαγείρεμα και για την ικανότητά του να διατηρεί την θερμοκρασία στο σύμμα του περισσότερο από αδιά σκευή. Αυτά τα προσόντα χρειάζεται ένα σκεύος για να χρησιμοποιηθεί στον μπουφέ και στην κουζίνα με την ίδια επιτυχία.

Cast iron cookware are known for their amazing cooking and the ability to maintain temperature. These skills are required from cookware in order to be used in the buffet and in the kitchen with the same success.

**Silver**

buffet – service

223

ΖΕΣΤΟΣ ΜΠΟΥΦΕΣ

 <i>Silver</i>	53.10021 μαντεμένο ταψί <i>cast iron pan</i> 22x30,2 cm pack: 1
 <i>Silver</i>	53.10022 μαντεμένο ταψί <i>cast iron pan</i> 26x40,2 cm pack: 1
	μαντεμένιοι δίσκοι GN <i>cast iron GN trays</i> 53.10023 GN 2/3   6,5 cm pack: 1
	53.10024 GN 1/1   2 cm pack: 1
<i>Silver</i>	53.10025 GN 1/2   6,5 cm pack: 1

 <i>Silver</i>	κασταρόλα μαντεμένα <i>cast iron cooking pots</i> 53.10000 10 cm pack: 1
	53.10001 14 cm pack: 1
	53.10002 20 cm (2,5 lt) pack: 1
	53.10003 24 cm (4 lt) pack: 1
	53.10004 28 cm (6 lt) pack: 1

 <i>Silver</i>	κασταρόλα μαντεμένα ρηχή <i>cast iron cooking pots shallow</i> 53.10005 24 cm (2,5 lt) pack: 1
	53.10006 28 cm (3,4 lt) pack: 1

 <i>Silver</i>	κασταρόλα μαντεμένα οβάλ <i>cast iron cooking pots oval</i> 53.10007 15x33 cm (4 lt) pack: 1
	53.10008 23x30 cm (5 lt) pack: 1



## carving set



96.33018 **barbeque οσετ μαχαίρι - μασάτι** TRAMONTINA  
*barbecue set,*  
*meat knife with sheath and sharpener*  
 20 cm  
 pack: 1



96.33011 **μαχαίρι ψητού με ξύλινη λαβή rosewood**  
*carving knife, rosewood handle* TRAMONTINA  
 15,4/27,8 cm  
 pack: 1



96.33012 **πιρούνα ψητού με ξύλινη λαβή rosewood**  
*carving fork, rosewood handle* TRAMONTINA  
 15,3/32,3 cm  
 pack: 1



96.35010 **μαχαίρι ψητού | carving knife**  
 20 cm VICTORINOX  
 pack: 1



96.35011 **πιρούνα ψητού | carving fork, 15 cm**  
 7.7233.15G



30.10233 **μαχαίρι ψητού | carving knife, 25 cm**  
 01.0032.1500 HEPP



30.11034 **πιρούνα ψητού | carving fork, 22,5 cm**  
 01.0032.1510 HEPP

**δοχεία σάλτσας μελαμίνης | dressing pots**  
 1,5 lt (13 cm | 19,5 cm)

27.84860 **μπεζ | beige**  
 «French dressing»  
 pack: 1

27.84861 **κόκκινο | red**  
 «Cocktail dressing»  
 pack: 1

27.84862 **πράσινο | green**  
 «Italian dressing»  
 pack: 1



**δοχεία σάλτσας μελαμίνης**  
*melamine dressing pots*  
 1 lt (12 cm | 21,5 cm)

27.83867 **λευκό | white**  
 pack: 1

27.83868 **μαύρο | black**  
 pack: 1



**δοχεία σάλτσας πορσελάνης**  
*porcelain dressing pots*

27.83309 **2,3 lt (18,5 cm | 17 cm)**  
 pack: 1

27.83310 **2 lt (17 cm | 15 cm)**  
 pack: 1

27.83311 **80 cl (13 cm | 13 cm)**  
 pack: 1





*contoured carving station*

carving station, ηλεκτρικό,  
με θερμαινόμενη βάση 100 W  
inox/μάρμαρο  
*carving station, electric with bottom heat*

\*30.20050 με 1 λάμπα | *with 1 lamp* (275 W)  
45x44 cm | 62 cm pack: 1

\*30.20044 με 2 λάμπες | *with 2 lamps* (275 W)  
63,5x46 cm | 62 cm pack: 1 **Spring**



*λάμπες θέρμανσης | heat shade*



λάμπες θέρμανσης ηλεκτρικές, inox  
για διατήρηση ζεστών φαγητών, κρέατος, κ.λπ.

\*30.20065 με 1 λάμπα | *with 1 lamp*  
27x18 cm | 61,5 cm pack: 1 **Spring**

\*30.20076 με 2 λάμπες | *with 2 lamps*  
27x18 cm | 61,5 cm pack: 1



96.33026 meat claw  
22846/100 st. st. λεπίδες  
και ξύλινη λαβή  
13,1x13/37 cm  
pack: 1

96.33027 meat claw ABS,  
22847/100 σετ 2 τμχ.  
13,1x13/37 cm  
pack: 1



\*27.83801 spoon rest, melamine  
26x10,5 cm | 5 cm  
pack: 1



27.83897 spoon rest, melamine  
26x13 cm  
pack: 1



\*27.83803 spoon rest, melamine  
22,5x11 cm | 6 cm  
pack: 1



*spoon rests*

30.40986 spoon rest, inox  
27x11,5 cm  
pack: 1

27.30060  
δοχείο σάλτσας διπλού τοιχώματος  
*double wall dressing pot*  
inox  
1,4 lt (13 cm | 19 cm)  
pack: 1

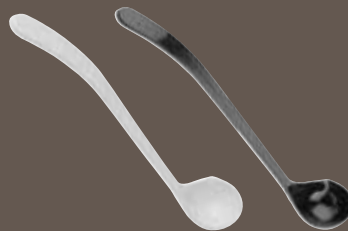

κουτάλες σάλτσας, SAN  
*dressing spoon, SAN*  
6 cm | 34 cm  
27.88636  
λευκή | *white*  
pack: 1  
27.88609  
μαύρη | *black*  
pack: 1

*δοχεία σάλτσας | dressing pots*



27.84863  
ξύλινη εταζέρα  
για 3 δοχεία σάλτσας  
*wooden station*  
for 3 dressing pots  
40x16 cm | 9 cm  
pack: 1





**FRILICH**  
THE ORIGINAL



### «Cup»

δοχείο μαρμελάδας ακρυλικό ημιδιάφανο με ανοξείδωτη βάση και καπάκι  
plastic pot for jam presentation, st. steel lip, incl. base model st. steel

\*28.10050 0,6 lt  
ECO006E100 17x15,4 cm | 17,5 cm  
pack: 1



### «Solo»

ισοθερμική st. steel βάση (με 3 ψυκτικά) με πλαστική καράφα και ανοξείδωτο καπάκι  
insulated base including 3 cooling packs and stainless steel shell, with plastic carafe

28.10055 1,2 lt  
ESC012E002 16,5 cm | 31 cm  
pack: 1

226

### «Connect»

διανεμητής δημητριακών με ανοξείδωτη 18/10 βάση και περιστρεφόμενο μηχανισμό με πτερύγια σιλικόνης  
rotary dispenser st. st. for muesli presentation, acrylic container; incl. st. steel base

\*28.10008 2,5 lt  
ETO250E100 17x19 cm | 72,5 cm  
pack: 1

\*28.10009 3,5 lt  
ETO350E100 17x19 cm | 82,5 cm  
pack: 1

\*28.10022 4,5 lt  
ETO450E100 17x19 cm | 96,5 cm  
pack: 1



### «Connect»

διανεμητής χυμών με 2 παγοκύστες (εσωτερικά στη βάση και στο καπάκι), ανοξείδωτη 18/10 βάση, βρύση non-drip και st. steel βάση ποτηριού  
juice dispenser st. steel, acrylic container; cooling pack in the base and in the small bowl below the lid, incl. steel base modul and drip tray

\*28.10002 3 lt  
ESC030E101 17x19 cm | 68,5 cm  
pack: 1

\*28.10005 4 lt  
ESC040E101 17x19 cm | 82,5 cm  
pack: 1



## «Quintet»



ισοθερμικές ανοξείδωτες βάσεις με 5 μπουκάλια με inox καπάκια και θέση για πάγο  
*beverage-set, double wall st. steel bowl 3 bottles with st. steel lids and st. steel crushed ice tube in center*  
 35 cm | 33 cm

\*28.10052 ESC060E001  
 λεία βάση με  
 5 ακρυλικά μπουκάλια  
*polished, 5 plastic carafes*  
 pack: 1

\*28.10051 ESC060E  
 λεία βάση με  
 5 γυάλινα μπουκάλια  
*polished, 5 glass carafes*  
 pack: 1

\*28.10054 ESC060E003  
 σφυρήλατη βάση με  
 5 ακρυλικά μπουκάλια  
*hammered, 5 plastic carafes*  
 pack: 1

\*28.10053 ESC060E002  
 σφυρήλατη βάση με  
 5 γυάλινα μπουκάλια  
*hammered, 5 glass carafes*  
 pack: 1

## «Triplet»



ισοθερμικές ανοξείδωτες βάσεις με 3 μπουκάλια με inox καπάκια και θέση για πάγο  
*beverage-set, double wall st. steel bowl 3 bottles with st. steel lids and st. steel crushed ice tube in center*  
 32 cm | 33 cm

\*28.10003 ESC036E001  
 λεία βάση με  
 3 ακρυλικά μπουκάλια  
*polished, 3 plastic carafes*  
 pack: 1

\*28.10023 ESC036E  
 λεία βάση με  
 3 γυάλινα μπουκάλια  
*polished, 3 glass carafes*  
 pack: 1

\*28.10024 ESC036E003  
 σφυρήλατη βάση με  
 3 ακρυλικά μπουκάλια  
*hammered, 3 plastic carafes*  
 pack: 1

\*28.10004 ESC036E002  
 σφυρήλατη βάση με  
 3 γυάλινα μπουκάλια  
*hammered, 3 glass carafes*  
 pack: 1

## «Goblet»



δοχείο δημητριακών  
 πορσελάνης με ανοξείδωτη βάση  
*muesli bar, china slide for muesli presentation, incl. base model st. steel*

\*28.10007 2 lt  
 ETO200E100 17x22 cm | 30,5 cm  
 pack: 1



καπάκι διάφανο με ανοξείδωτη βάση και ανοξείδωτο χερούλι  
*st. steel holding device, transparent plastic hood, with st. steel handle*



\*28.10011 40 cm | 31 cm  
 NB 001 E pack: 1



\*28.10078 30 cm | 33,5 cm  
 NB 004 E pack: 1



\*28.10084 30 cm | 26 cm  
 EB 543 E pack: 1



ανοξείδωτη βάση με ψυκτικό και δίσκο πορσελάνης  
*st. steel base with plastic insert and cooling cushions with circular china plate*

\*28.10083 30,5 cm | 4,5 cm  
 EFC000E018 pack: 1



βάση «ψάθα» (πλαστικό), ψυκτικό και πορσελάνινο δοχείο  
*base made of dishwasher proof wicker basket (plastic), insulated cooling inset, cooling cushion*

\*28.10012 μπεζ | beige  
 NFC000B402 41 cm | 7 cm  
 pack: 1

\*28.10076 μπεζ | beige  
 NFC030B302 31 cm | 14,5 cm  
 pack: 1

\*28.10013 γκρι | grey  
 NFC000B403 41 cm | 7 cm  
 pack: 1

\*28.10077 γκρι | grey  
 NFC030B303 31 cm | 14,5 cm  
 pack: 1



ψυκόμενο ακρυλικό μπολ με ανοξείδωτη βάση & καπάκι  
*plastic-ring, insert plate made of st. steel, cooling pack, lid incl. knob made of st. steel*

\*28.10001 1,5 lt (18,5 cm | 18,5 cm)  
 EFC015E002 pack: 1

\*28.10060 2,5 lt (18,5 cm | 22,5 cm)  
 EBC025E001 pack: 1



καπάκι roll top GN 1/1  
*roll top hood GN 1/1*

\*28.10082 55x35 cm | 24 cm  
 10078 pack: 1

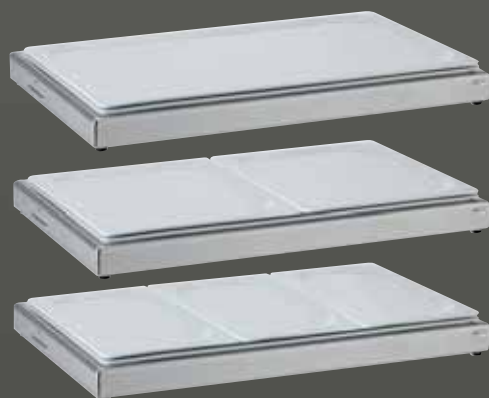

ανοξείδωτη βάση με ψυκτικό και πιατέλα πορσελάνης  
*GN st. steel base with plastic insert and cooling cushions, GN china plates*  
 55x34,5 cm | 5,5 cm

\*28.10079 με 1 πιατέλα GN 1/1  
 EFC000E019 with 1 china plate GN 1/1  
 pack: 1

\*28.10080 με 2 πιατέλες GN 1/2  
 EFC000E020 with 2 china plates GN 1/2  
 pack: 1

\*28.10081 με 3 πιατέλες GN 1/3  
 EFC000E021 with 3 china plates GN 1/3  
 pack: 1



διανεμητής γάλακτος ανοξείδωτος, με παγοκύστη στη βάση, εσωτερική στήλη για θρυμματισμένο πάγο και βρυσάκι  
milk dispenser st. steel, incl. crushed ice tube and st. steel faucet

\*28.10026 3 lt  
EMC030E 20,5x33,6 cm | 40 cm  
pack: 1

\*28.10027 5 lt  
EMC050E 23,5x37 cm | 44 cm  
pack: 1



## «Elegance»

διανεμητής χυμού με παγοκύστη στη βάση και εσωτερική στήλη για θρυμματισμένο πάγο, ανοξείδωτη βάση και βρυσάκι  
juice dispenser st. steel, incl. crushed ice tube and st. steel faucet

\*28.10014 2,5 lt, διάφανο δοχείο  
ESC025E transparent container  
20,5x33,6 cm | 43,5 cm  
pack: 1

\*28.10016 5 lt, διάφανο δοχείο  
ESC050E transparent container  
23,5x37 cm | 49 cm  
pack: 1

\*28.10015 2,5 lt, ημιδιάφανο δοχείο  
ESC025E900 translucent container  
20,5x33,6 cm | 43,5 cm  
pack: 1

\*28.10017 5 lt, ημιδιάφανο δοχείο  
ESC050E900 translucent container  
23,5x37 cm | 49 cm  
pack: 1



ψυχόμενο PC μπολ υψηλής ποιότητας λευκό PC και δαχτυλίδι, διαφανές πλαστικό καπάκι, inox μπολ και ψυκτικά)

freshness dish «Buffet bowl» high-grade plastic bowl and decoration ring (PC, white), transparent plastic lid, stainless steel insert bowl, cooling pack

28.10028 1,5 lt  
EFC015K 22,8 cm | 15,8 cm  
pack: 1



ανοξείδωτη βάση με 3 πλαστικά δοχεία για μαρμελάδα 0,6 lt  
steel lid base with 3 plastic jam pots 0,6 lt

28.10000 47x14 cm | 18 cm  
ECO018E pack: 1



ανοξείδωτη βάση με 4 πλαστικά δοχεία για μαρμελάδα 0,6 lt  
steel lid base with 4 plastic jam pots 0,6 lt

28.10061 60x14 cm | 18 cm  
ECO024E004 pack: 1



βάση με ακρυλικές κανάτες (1,5 lt) για δημητριακά (διαθέτουν ανοξείδωτα καπάκια καθώς και πλαστικά για φύλαξη)  
muesli bar with 3 plastic flute incl. st. steel press-on lid and 'good night lid'

\*28.10006 3 θέσεων | 3 flutes  
ETO045E002 47x14 cm | 29 cm  
pack: 1

**FRILICH**  
THE ORIGINAL



διανεμητής μελιού, 1 kg, ανοξείδωτος  
honey holder for 1 kg liquid honey container and dispensing valve are dishwasher-proof, stainless steel lid

\*28.10025 21x23,5 cm | 35 cm  
EHO010E pack: 1





διανεμητής χυμών, γυάλινος σε ξύλινο δρύινο πλέγμα με st. steel βάση ποτηριού  
*wooden oak stand, decore st. steel frame, cooling cushion, drip tray, glass barrel with universal adapter and st. steel faucet*

\*28.10062 5 ltr  
RSC050H008 25x33 cm | 47,8 cm  
pack: 1

\*28.10063 8 ltr  
RSC080H008 25,1x36 cm | 52,5 cm  
pack: 1



ξύλινο κιβώτιο με 3 ψυκτικά και 3 γυάλινα μπουκάλια  
*wooden crate, 3 plastic insets and cooling pack holder, 3 cooling packs, 3 glass bottles with milk motif (1,0 lt ea.)*

\*28.10065 φυσικό | *nature*  
LSC030H001 41x17 cm | 44,5 cm  
pack: 1

\*28.10010 λευκό vintage |  
LSC030H003 *vintage white*  
41x17 cm | 44,5 cm  
pack: 1

ξύλινη βάση οξιάς  
*natural beech cheese stand*

\*28.10070 22x22 cm | 16,5 cm  
3ST083 pack: 1

\*28.10069 22x22 cm | 21 cm  
3ST082 pack: 1



«S-Cube»

ξύλινη βάση οξιάς  
*natural beech cheese stand*

\*28.10071 32,5x22 cm | 12 cm  
3ST125 pack: 1

\*28.10072 32,5x22 cm | 16,5 cm  
3ST126 pack: 1

\*28.10073 32,5x22 cm | 21 cm  
3ST127 pack: 1



ξύλινη βάση οξιάς και 3 πορσελάνινα μπολ  
*condiment display, natural beech base and 3 china bowls*

\*28.10066 «Bowl Bar S»  
RCO015X002 3 x 0,5 lt  
45x12,5 cm | 21 cm  
pack: 1

\*28.10067 «Bowl Bar M»  
RCO045X002 3 x 1,5 lt  
60x19 cm | 28,5 cm  
pack: 1

\*28.10068 «Bowl Bar L»  
RCO105X002 3 x 3,5 lt  
75x25 cm | 37,5 cm  
pack: 1



δοχείο πορσελάνης 2 lt σε ξύλινη βάση οξιάς  
*freshness dish 2 lt, natural beech base*

\*28.10064 25x25 cm | 27 cm  
RFC020X pack: 1



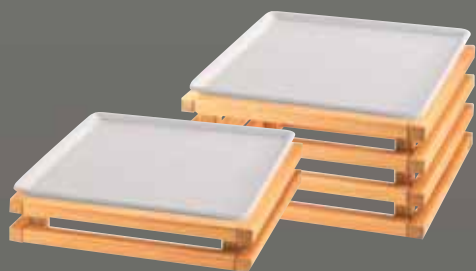

ξύλινη δρύινη βάση με ψυκτικό και δίσκος πορσελάνης 33x33 cm  
*china plate 33x33 cm with cooling cushioning system on oak base frame*

\*28.10074 35,1x35,1 cm | 8,9 cm

F01.401.0000 pack: 1

\*28.10075 35,1x35,1 cm | 18,4 cm

F01.400.0000 pack: 1



ξύλινη δρύινη βάση με ψυκτικό και δοχείο με καπάκι 23x23 cm  
*china dish 23x23 cm with lid, cooling cushioning system on oak base frame*

\*28.10089 25,2x25,2 cm | 22,3 cm

F06.401.0000 pack: 1

\*28.10090 25,2x25,2 cm | 31,8 cm

F06.400.0000 pack: 1

ξύλινη δρύινη βάση με inox δίσκο, ψυκτικά  
*stainless steel tray incl. three cooling fins, on oak base frame*

\*28.10102 με 9 γυάλινα μπουκάλια (0,2 lt)  
*with 9 swing top bottles (0,2 liters)*

25,2x25,2 cm | 36,5 cm

F10.400.0000 pack: 1

\*28.10103 με 20 γυάλινα μπουκάλια (0,2 lt)  
*20 swing top bottles (0,2 liters)*

35,2x35,5 cm | 36 cm

F09.400.0000 pack: 1



δοχείο πορσελάνης (1,5 lt)  
με καπάκι σε ξύλινο δρύινο πλέγμα  
με st. steel βάση  
*china bowl with lid (1,5 lt) on oak base  
frame, st. steel decor frame*

\*28.10085 25,1x25,1 cm | 27,4 cm

F08.401.0000 pack: 1

\*28.10086 25,1x25,1 cm | 36,7 cm

F08.400.0000 pack: 1

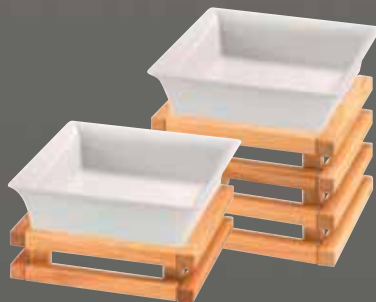

ξύλινη δρύινη βάση με ψυκτικό  
και δοχείο πορσελάνης 23x23 cm  
*china bowl 23x23 cm with cooling cushioning  
system on oak base frame*

\*28.10087 25,4x25,4 cm | 14 cm

F04.401.0000 pack: 1

\*28.10088 25,4x25,4 cm | 23,5 cm

F04.400.0000 pack: 1



ξύλινος κάδος με πλαστικό εσωτερικό  
και 7 γυάλινα μπουκάλια (1 lt) και  
σύστημα στήριξης μπουκαλιών  
*wooden bucket (black lucust wood),  
plastic inset (transparent), support frame  
for bottle setup, chromium-plated*

\*28.10091 φυσικό | *nature*

LSC070H001 40 cm | 36,3 cm

pack: 1

\*28.10092 λευκό vintage | *vintage white*

LSC070H002 40 cm | 36,3 cm

pack: 1

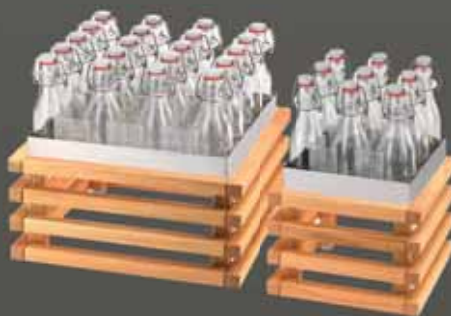

πέτρινες βάσεις για πινακιδάκια  
*natural stone label holder*

\*28.10056 μάρμαρο | *carrara*

3SH010 pack: 1

\*28.10057 γρανίτης | *granite*

3SH011 pack: 1

\*28.10058 βασάλτης | *basalt*

3SH012 pack: 1

ξύλινη βάση  
για πινακιδάκια  
*wood label holder*

\*28.10059 κερασιά | *cherry*

3SH013 pack: 1

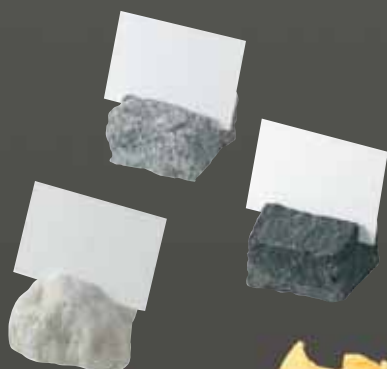

προσαρμογές για βρυσάκια APS

*APS hand contactless adapter*

εφαρμόζει στα βρυσάκια  
Top Fresh και Sunday

*fits all Top Fresh  
and Sunday dispensers*



27.10802

προσαρμογές για βρυσάκια  
*band contactless adapter,*  
*easy to install*  
12x4,5 cm | 5,5  
pack: 1

APS



BUFFET PROTECTION – BUFFET PROTECTION – BUFFET PROTECTION –

### καπάκια για δοχεία μεδαμίνης

Καπάκια για την προστασία του φαγητού. Ερμητικό κλείσιμο, ασφαλής μεταφορά, χωρίς βρα.

*Covers for bowls. Protection for your food, tightly closing, slosh-proof transport, bpa-free*

### καπάκια «Pure» PP



σετ 5 καπάκια PP | *cover PP, 5 pieces set*

τετράγωνα | *rectangular*

\*27.83603 13x13 cm  
(για μπολ/fits to bowls: 12,5x12,5)  
pack: 1

\*27.83604 19,5x19,5 cm  
(για μπολ/fits to bowls: 19x19)  
pack: 1



σετ 5 καπάκια PP | *cover PP, 5 pieces set*

στρογγυλά | *round*

\*27.83605 8 cm  
(για μπολ/fits to bowls: 8 cm)  
pack: 1

\*27.83606 14,5 cm  
(για μπολ/fits to bowls: 14 cm)  
pack: 1

\*27.83607 20,5 cm  
(για μπολ/fits to bowls: 20,5 cm)  
pack: 1



### καπάκια «Frida» SAN



καπάκια SAN | *cover SAN*

στρογγυλά | *round*

\*27.84962 9 cm | 2,5 cm  
(για μπολ/fits to bowls:  
84930, 84931 cm)  
pack: 1

\*27.84963 13 cm | 2,5 cm  
(για μπολ/fits to bowls:  
84605, 84606)  
pack: 1

\*27.84964 16 cm | 2,5 cm  
(για μπολ/fits to bowls:  
84607, 84608)  
pack: 1



τετράγωνα | *square*

\*27.84965 13x13 cm | 2,5 cm  
(για μπολ/fits to bowls:  
84937, 84936)  
pack: 1

\*27.84966 17x17 cm | 2,5 cm  
(για μπολ/fits to bowls:  
84558, 84559)  
pack: 1



παράλληλόγραμμα | *rectangular*

\*27.84967 18x16,5 cm | 2,5 cm  
(για μπολ/fits to bowls:  
84584, 84583)  
pack: 1

\*27.84968 18x11 cm | 2,5 cm  
(για μπολ/fits to bowls:  
84556, 84555)  
pack: 1

## «Flexible»

Για συγκράτηση του καλύμματος από τη λαβή του.  
Κατάλληλο για τα περισσότερα καλύμματα με λαβή.  
With this cover holder, the cover is inserted into the device by the handle.  
Suitable for many APS covers and covers with handle.



27.06521  
καπάκι καμπάνα PC  
PC cover  
36 cm | 27 cm  
pack: 1

\*27.11026  
καπάκι SAN GN 1/1  
SAN cover GN 1/1  
54x33 cm | 20 cm  
pack: 1

Ρυθμιζόμενη γωνία κλίσης.  
Inclination angle continuously adjustable.

27.33288  
στήριγμα καλυμμάτων  
cover holder  
32x30 cm | 38 cm  
pack: 1



## - BUFFET PROTECTION – BUFFET PROTECTION – BUFFET PROTECTION

μεταβλητό ύψος  
της ακρυλικής πλάκας  
σε 3 στάδια

variable height adjustment  
of the acrylic plate  
in 3 steps

διαμόρφωση  
της γωνίας κλίσης

change the angle  
of inclination  
by tightening  
the screws

αντιολισθητικά  
πόδια  
non-slip  
feet



## sneeze guard

Μεταλλικό προστατευτικό μπουφέ. Διαφανής, ρυθμιζόμενη καθ' ύψος ακρυλική πλάκα, με ρυθμιζόμενη γωνία κλίσης. Για την προστασία των φαγητών.

Sneeze guard transparent, height-adjustable acrylic plate, whose angle of inclination can be continuously adjusted, protects the food.

27.98120 αντιπερριστικό | sneeze guard  
93x53 cm | 50,5 cm  
pack: 1



σετ 7 τεμαχίων:

1 δοχείο (30x25 cm | 8 cm) + 1 καπάκι  
+ 1 μεγάλο μπολ (23x14 cm | 6 cm)  
+ 1 μεσαίο μπολ (14x11,5 cm | 6 cm)  
+ 2 μικρά μπολ (11,5x7 cm | 6 cm)  
+ 1 αντιολισθητικό ταπέτο



## «Serving Box»

7 pieces set:

1 box (30x25 cm | 8 cm), + 1 cover  
+ 1 bowl, large (23x14 cm | 6 cm)  
+ 1 bowl, medium (14 x 11,5 x 6 cm)  
+ 2 bowls, small (11,5 x 7 x 6 cm)  
+ 1 non-slip mat

\*27.85091 χρώμα μπεζ | beige  
30x25 cm | 8 cm  
pack: 1

\*27.85088 χρώμα μαύρο | black look  
30x25 cm | 8 cm  
pack: 1





βιτρίνες / stand κρύων | cool showcases



APS

βιτρίνα κρύων «Top Fresh», ακρυλική με ένα ανοξείδωτο δίσκο GN 1/1 και δύο ψυκτικά (χωρίς καπάκι)

*cooling box «Top Fresh», acrylic with 1 tray GN 1/1, 2 coolers (without cover)*

56,5x35 cm | 6,5 cm

\*27.11503 λευκή

pack: 1

\*27.11505 μαύρη

pack: 1



καπάκι roll-top, PC με λαβή χρωμίου

*roll top cover with chrome plated handle*

27.11010 53x32,5 cm | 17 cm

pack: 1



APS

\*27.11000 δίσκος | tray inox, GN 1/1,

pack: 1



APS

βιτρίνα κρύων «Top Fresh», inox, με ένα δίσκο GN 1/1 και δύο ψυκτικά (χωρίς καπάκι)

*cooling box «Top Fresh», inox with 1 tray GN 1/1, 2 coolers (without cover)*

\*27.11590 56,5x36 cm | 8,5 cm

pack: 1



APS

βιτρίνα κρύων «Focus», plastic, με δίσκο inox και 2 δύο ψυκτικά, (χωρίς καπάκι) | cooling box «Focus», plastic, 1 tray inox, 2 coolers (without cover)

43,5x32,5 cm | 6 cm

\*27.09000 λευκή | white

pack: 1

\*27.09001 μαύρη | black

pack: 1



καπάκι roll-top SAN με λαβή χρωμίου

*roll top cover SAN with chrome plated handle*

27.09013 44x33,5 cm | 17 cm

pack: 1



HENDI

ψυχόμενη βιτρίνα GN 1/1 ABS / PC, μαύρη, καπάκι PC, με δίσκο inox GN 1/1 και ψυκτικό

*cooled roll-top display, GN 1/1 ABS / PC with 1 GN 1/1 inox tray cover and cooler*

30.40987 55,5x35,7 cm | 17,5 cm

pack: 1



HENDI

ψυχόμενη βιτρίνα roll top ABS, μαύρη, καπάκι SAN, με δίσκο inox και 2 ψυκτικά

*cooled roll-top display ABS, with 1 inox tray, cover SAN and 2 coolers*

30.40385 44x32 cm | 20,5 cm

pack: 1



βιτρίνες / stand κρύων | cool showcases



APS

σετ roll-top (δίσκος inox και καπάκι roll-top SAN)

*set roll-top (inox tray and SAN roll-top cover)*

27.09080 38 cm | 24 cm

pack: 1

\*27.09099 50 cm | 28 cm

pack: 1



APS

thermo-set (δύο δίσκοι inox, καπάκι roll-top SAN και δύο ψυκτικά)

*thermo-set (2 inox trays, SAN roll-top cover and 2 coolers)*

27.09082 38 cm | 24 cm

pack: 1



APS

thermo-set (βάση inox με πόδι, δίσκος inox και δύο ψυκτικά - χωρίς καπάκι)

*thermo-set (1 deep inox tray with feet, 1 inox tray and 2 coolers, without cover)*

\*27.09083 38 cm | 14,5 cm

pack: 1



APS

βιτρίνα κρύων «Focus» στρογγυλή, με 1 δίσκο inox, 1 cooler, χωρίς καπάκι

*cool showcase «Focus» round 1 inox tray, 1 cooler (without cover)*

\*27.09002 λευκή | white, 38 cm

pack: 1

\*27.09003 μαύρη | black, 38 cm

pack: 1

\*27.09023 καπάκι / cover roll-top SAN 38 cm

pack: 1



καπάκι roll-top SAN - λαβή χρωμίου

*roll top cover with chrome plated handle*

27.18388 38 cm | 20 cm

pack: 1

\*27.83869 δίσκος μελαμίνης

*melamine tray*

38 cm

pack: 1

## «Top Fresh»

διανεμητές γιαουρτιού /μαρμελάδας



APS

«Top Fresh» set, inox  
γυάλινο μπολ, καπάκι και ψυκτικό  
*glass bowl, cover and cooler*

27.11845 2,5 lt (23 cm | 14 cm)  
pack: 1

27.11849 4 lt (22 cm | 18 cm)  
pack: 1



«Top Fresh» set, inox  
PC μπολ, καπάκι και ψυκτικό  
*PC bowl, cover and cooler*

\*27.11810 0,6 lt (14 cm | 9 cm)  
pack: 1

27.11815 1 lt (14 cm | 11,5 cm)  
pack: 1



«Top Fresh» set, wood  
ξύλινη βάση, PC μπολ, καπάκι  
και ψυκτικό  
*wooden base, PC bowl, cover and cooler*

27.11812 0,6 lt (14 cm | 9 cm)  
pack: 1

27.11813 1 lt (14 cm | 11,5 cm)  
pack: 1



καπάκι ακρυλικό με λαβή χρωμίου  
*acrylic lid, chrome plated handle*

27.11868 14,5 cm  
pack: 1

27.11878 23 cm  
pack: 1

## διανεμητές musli/μαρμελάδας | musli/jam dispensers



«Sunday»  
stand μπουφέ, χρωμίου,  
με 3 γυάλινα μπολ 23 cm (2,5 lt)  
και καπάκια PC

*buffet stand with 3 glass bowls 23 cm (2,5 lt)  
and PC covers*

27.11795 61x24 cm | 35 cm  
pack: 1

## βάση με μπουκάλια | tray with bottles



μεταλλική μαύρη βάση με  
ανοξείδωτο δίσκο, ψυκτικά και 20  
γυάλινα μπουκάλια (0,2 lt)  
*stainless steel tray incl. three cooling fins,  
with 20 swing top bottles (0,2 liters) on  
black steel base frame*

\*28.10104 33,5x33,5 cm | 35 cm  
F09.100.0000 pack: 1

μεταλλική μαύρη βάση με  
ανοξείδωτο δίσκο, ψυκτικά και 9  
γυάλινα μπουκάλια (0,2 lt)  
*stainless steel tray incl. three cooling fins,  
with 9 swing top bottles (0,2 liters) on  
black steel base frame*

\*28.10105 23,6x23,6 cm | 33,2 cm  
F10.100.0000 pack: 1

APS

## «Bridge»



διανεμητές χυμού | *juice dispensers*  
«Bridge», wood/inox/PC

\*27.10870 4 lt  
31x20 cm | 42 cm  
pack: 1

\*27.10871 6 lt  
35,5x22 cm | 50 cm  
pack: 1

διανεμητής χυμού | *juice dispenser*  
«Bridge», wenge/inox/PC

\*27.10872 4 lt  
31x20 cm | 42 cm  
pack: 1

\*27.10873 6 lt  
35,5x22 cm | 50 cm  
pack: 1



διανεμητές γάλακτος  
*milk dispensers*  
«Bridge» wood/inox/PC

\*27.10836 3 lt,  
31x20 cm | 39 cm  
pack: 1

\*27.10838 5 lt,  
39x22 cm | 45 cm  
pack: 1

διανεμητές γάλακτος  
*milk dispensers*  
«Bridge» wenge/inox/PC

\*27.10837 3 lt,  
31x20 cm | 39 cm  
pack: 1

\*27.10839 5 lt,  
39x22 cm | 45 cm  
pack: 1



διανεμητές δημητριακών  
*cereal dispensers*  
«Bridge» wood/inox/PC

\*27.13987 4,5 lt,  
21x20 cm | 55,5 cm  
pack: 1

διανεμητές δημητριακών  
*cereal dispensers*  
«Culture form» wenge/inox/PC

\*27.14987 4,5 lt  
21x20 cm | 55,5 cm  
pack: 1

διανεμητές δημητριακών | cereal dispensers



διανεμητής δημητριακών  
cereal dispenser  
«Fresh & Easy», PC/plastic

27.11805 4,5 lt  
22x17,5 cm | 52 cm  
pack: 1

διανεμητής δημητριακών  
cereal dispenser  
«Fresh & Easy», PC/plastic

27.11807 2x4,5 lt  
22x35 cm | 52 cm  
pack: 1



διανεμητής δημητριακών μαύρος  
cereal dispenser  
«Fresh & Easy», PC/plastic

\*27.11840 4,5 lt  
22x17,5 cm | 52 cm  
pack: 1

διανεμητής δημητριακών μαύρος  
cereal dispenser  
«Fresh & Easy», PC/plastic

\*27.11841 2x4,5 lt  
22x35 cm | 52 cm  
pack: 1



«Classic»  
διανεμητές  
δημητριακών  
cereal dispensers  
inox/PC

\*27.11833 8 lt  
35x26,5 cm | 68 cm  
pack: 1

\*27.11834 διπλός | double  
2x8 lt  
35x50 cm | 68 cm  
pack: 1

«Good morning»



ξύλινη βάση stand μπουφέ, με θέσεις για 3 βάζα  
wooden buffet stand for 3 glass jars

27.13964 φυσικό | natural, 43x17 cm  
pack: 1

27.14964 wenge, 43x17 cm  
pack: 1

00.30034 γυάλινο βάζο | jar, 2 lt  
pack: 1/6



service stands









σταντ inox, με πλαστικές θήκες  
multi-rack, inox stand with plastic bowls

27.11444 3 θήκες | 3-tier  
19x14 cm | 41 cm  
pack: 1

\*27.11446 4 θήκες | 4-tier  
19x31 cm | 53 cm  
pack: 1



διανεμητές χυμού | *juice dispensers*

	<p>*27.10409 «Old fashioned», 7 lt διανεμητής χυμού γαυλί/μέταλλο <i>juice dispenser glass/metall</i> 27 cm   50,5 cm pack: 1</p>		<p>*27.10420 «Fresh white», 4,5 lt διανεμητής χυμού γαυλίνος, ξύλινη λευκή βάση με φελλό <i>juice dispenser, container with stainless steel tab and wooden cover; solid glas, incl. white wooden base and cork coaster</i> <i>glass/wood</i> 23x23 cm   56,5 cm pack: 1</p>
	<p>*27.10403 «Asia», 7 lt διανεμητής χυμού γαυλί/μέταλλο <i>juice dispenser glass/wood</i> 24,5 cm   45,5 cm pack: 1</p>		<p>*27.10430 «Fresh white», 4,5 lt διανεμητής χυμού γαυλίνος, ξύλινη βάση με φελλό <i>juice dispenser container with stainless steel tab and cork cover; solid glas, incl. wooden base and cork coaster</i> <i>glass/wood</i> 23x23 cm   56,5 cm pack: 1</p>
	<p>*27.10400 «Element», 7 lt διανεμητής χυμού γαυλί/τοιμέντο <i>juice dispenser glass/concrete</i> 22 cm   45 cm pack: 1</p>		<p>*27.10415 «Element», 10,5 lt διανεμητής χυμού γαυλί/μέταλλο <i>juice dispenser glass/metall</i> 25 cm   58 cm pack: 1</p>
	<p>*27.10855 διανεμητής χυμού γαυλίνος με inox καπάκι <i>glass drink dispenser; inox lid</i> 7 lt 20 cm   30,5 cm pack: 1</p>		



## «Top Fresh»



APS

διανεμητές χυμού | *juice dispensers*  
«Top Fresh», inox/PC

27.10800 4 lt  
21x32 cm | 43 cm  
pack: 1

27.10700 6 lt  
23x35 cm | 52 cm  
pack: 1



APS

διανεμητής χυμού διπλός  
*double juice dispenser*  
«Top Fresh», inox/PC

\*27.10720 2x6 lt  
42x32 cm | 52 cm  
pack: 1



APS

διανεμητές γάλακτος | *milk dispensers*  
«Top Fresh», inox

\*27.10830 3 lt  
21x32 cm | 39 cm  
pack: 1

\*27.10750 5 lt  
23x35 cm | 45 cm  
pack: 1

## «Norma»

GARIBALDI



διανεμητής χυμού | *juice dispenser*  
«Norma black mat », inox/PC

96.50117 5 lt  
30x20 cm | 48 cm  
pack: 1



διανεμητής χυμού | *juice dispenser*  
«Norma black mat », inox/PC

96.50118 7 lt  
30x20 cm | 55 cm  
pack: 1



διανεμητής γάλακτος | *milk dispenser*  
«Norma black mat », inox/PC

96.50119 5 lt  
30x20 cm | 48 cm  
pack: 1

## προσαρμογές APS | *APS adapter*



APS



εφαρμόζουν στα βρυσάκια  
Top Fresh

*fits all Top Fresh dispensers*

27.10802 προσαρμογές για  
βρυσάκια για ανέπαφο  
σερβίρισμα  
*band contactless adapter;*  
*easy to install*  
12x4,5 cm | 5,5  
pack: 1

## ανταλλακτικά βρυσάκια APS | *APS non-drip tap*



εφαρμόζουν στους  
διανεμητές της APS

*for APS dispensers*

βρυσάκια για / *tap for:*

27.10707 6 lt χυμού & 5 lt γάλακτος  
*6 lt juice & 5 lt milk*  
pack: 1

27.10807 4 lt χυμού & 3 lt γάλακτος  
*4 lt juice & 3 lt milk*  
pack: 1

## «Top Fresh wood»

APS



διανεμητές γάλακτος «Top Fresh»  
(beech wood/porcelain)  
*milk dispenser*

\*27.10840 4 lt  
23x32 cm | 42 cm  
pack: 1

27.10757 10 lt  
27x38,5 cm | 45 cm  
pack: 1

διανεμητές χυμού | *juice dispensers*



30.40061 διανεμητής χυμού  
*juice dispenser*  
8 lt  
inox - PC  
36x26 cm | 56 cm  
pack: 1



30.41451 διανεμητής χυμού διπλός  
*double juice dispenser*  
2x8 lt  
inox - PC  
58x35 cm | 56 cm  
pack: 1

30.90173 ανταλλακτικό βρυσάκι  
*non-drip tap*  
(30.40061 - 30.41451)  
pack: 1



HENDI



30.41544 διανεμητής χυμού  
*juice dispenser*  
3 lt  
inox - PC  
21,5x31,5 cm | 49 cm  
pack: 1



30.41545 διανεμητής χυμού διπλός  
*double juice dispenser*  
2x3 lt  
inox - PC  
41,5x31,5 cm | 49 cm  
pack: 1

*ποιήτρια χυμού*

*Lyon*



00.10864  
juice, 20 cl  
7,1 cm | 8,6 cm  
pack: 6

*Lyon*



00.10863  
juice, 16 cl  
6,6 cm | 7,9 cm  
pack: 6

*Cibeles*



00.10201  
juice (set of 6), 14,6 cl  
6,3 cm | 7,5 cm  
pack: 1

*Rock bar*



00.13094  
juice, 20 cl  
7,6 cm | 8,4 cm  
pack: 6/48

*Stack*



70.10106  
«Stack», 26 cl  
6,7 cm | 9,5 cm  
pack: 6/72

*Stelvio*



01.10465  
χυμού, 16 cl  
5,9 cm | 10,4 cm  
συσκ.: 6







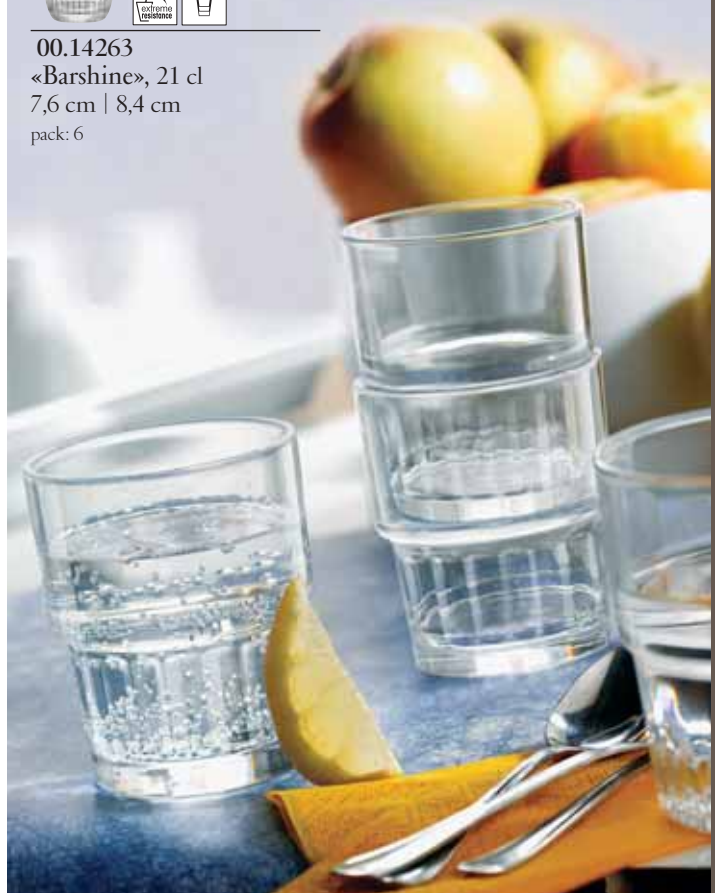

*Barshine*

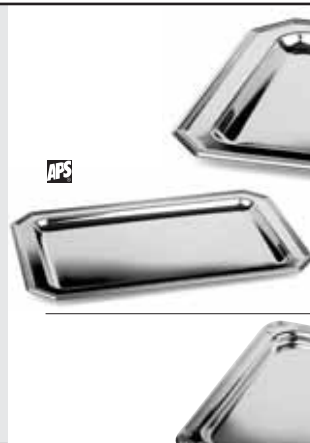

00.14263  
«Barshine», 21 cl  
7,6 cm | 8,4 cm  
pack: 6



σκεύη παρουσίασης inox | *inox display items*

	<p>«Sunday», δίσκοι inox   <i>inox trays</i>                      *27.11220 GN 1/1 (53x32,5 cm)                      pack: 1                      *27.11210 GN 1/2 (32,5x26,5 cm)                      pack: 1                      *27.11016 καπάκι roll-top GN 1/1                      cover GN 1/1, PC                      53x32,5 cm   19 cm                      pack: 1</p>		<p>«Elegance», δίσκοι inox   <i>inox trays</i>                      *27.02310 41x26 cm                      pack: 1                      *27.02311 48x30 cm                      pack: 1                      *27.02312 60x37 cm                      pack: 1</p>
	<p>«Tender» δίσκοι οβάλ, inox  <i>oval inox trays «Tender»</i>                      19.50410 26x19 cm                      pack: 10                      19.50411 31x21 cm                      pack: 10                      19.50412 36x25 cm                      pack: 10                      19.50413 42x29 cm                      pack: 10                      19.50414 47x34 cm                      pack: 10                      19.50415 53x35 cm                      pack: 10</p>		<p>«Profi Line», δίσκος inox   <i>inox tray</i>                      *27.11000 GN 1/1 (53x32,5 cm)                      pack: 1                      «Classic» δίσκος χρωμίου   <i>chrome tray</i>                      27.00395 GN 1/1 (53x32,5 cm)                      (να μην πλένεται στο πλυντήριο)                      pack: 1</p>
	<p>δίσκοι παραλλημοί, inox «Tender»  <i>rectangular inox trays «Tender»</i>                      19.50416 32x25 cm                      pack: 10                      19.50417 40x33 cm                      pack: 10                      19.50418 48x37 cm                      pack: 10                      19.50419 60x47 cm                      pack: 5</p>		<p>δίσκος χρωμίου οβάλ   <i>oval chrome tray</i>                      *27.00391 46x34 cm                      (να μην πλένεται στο πλυντήριο)                      pack: 1                      δίσκος χρωμίου   <i>chrome tray</i>                      *27.00394 GN 1/1                      (να μην πλένεται στο πλυντήριο)                      pack: 1</p>
	<p>δίσκοι οβάλ, inox                      30.40332 οβάλ, 40x26 cm                      pack: 1                      30.40333 οβάλ, 45x29 cm                      pack: 1                      30.40334 οβάλ, 50x35 cm                      pack: 1</p>		<p>«Swing», δίσκοι inox   <i>inox trays</i>                      *27.01416 32,5x32,5 cm                      pack: 1                      *27.01415 28,5x20 cm                      pack: 1                      *27.01420 GN 1/1 (53x32,5 cm)                      pack: 1</p>
	<p>καπάκια catering PC GN - <i>catering lids</i>                      καπάκια PC, στοιβαζόμενα  <i>catering lids, PC, stackable</i>                      *27.11041 GN 1/2                      32,5x26,5 cm   9,5 cm                      pack: 1                      *27.11042 GN 1/1                      53x32,5 cm   9,5 cm                      pack: 1</p>		<p>«Classic», inox                      δίσκος με χέρια, στοιβαζόμενος  <i>trays with handles, stackable</i>                      *27.11295 GN 1/1                      53x32,5 cm                      pack: 1                      *27.11305 καπάκι GN 1/1 cover                      53x32,5 cm                      pack: 1</p>

APS



27.30207 καλάθι μεταλλικό  
μαύρο με χάλκινο χέρι  
*basket, black metall  
with copper handle*  
21 cm | 16,5 cm  
pack: 1



27.30208 καλάθι μεταλλικό  
μαύρο με χάλκινο χέρι  
*basket, black metall  
with copper handle*  
30 cm | 19 cm  
pack: 1

APS



27.30206 φρουτιέρα, μαύρη  
*fruit basket, black*  
31 cm | 14 cm  
pack: 1



27.30205 φρουτιέρα, μεταλλική  
*fruit basket*  
31 cm | 14 cm  
pack: 1

Cosy  
&Trendy

30.80260 φρουτιέρα, χάλκινη  
*fruit basket, copper*  
23,5 cm | 15,5 cm  
pack: 1



30.80409 φρουτιέρα, χάλκινη  
*fruit basket, copper*  
30 cm | 15,5 cm  
pack: 1

Cosy  
&Trendy

30.80420 φρουτιέρα, bronze  
*fruit basket, bronze*  
33 cm | 11 cm  
pack: 1



30.41956 φρουτιέρα μεταλλική,  
μαύρη  
*fruit basket angled, black*  
28 cm | 13 cm  
pack: 1

HENDI



30.41953 φρουτιέρα, μεταλλική  
μαύρη  
*fruit basket angled, black*  
30 cm | 25 cm  
pack: 1

APS



\*27.30414 καλάθι GN 1/1  
*basket GN 1/1*  
53x32,5 cm | 7,5 cm  
pack: 1



\*27.30415 καλάθι GN 1/2  
*basket GN 1/2*  
32,5x26,5 cm | 7,5 cm  
pack: 1



\*27.30416 καλάθι GN 2/4  
*basket GN 2/4*  
53x16,2 cm | 7,5 cm  
pack: 1

καλάθια μεταλλικά | «Urban» *metall baskets*

στοιβάζονται και μπορούν να χρησιμοποιηθούν  
και σαν βάσεις για δίσκους ή τα ίδια τα καλάθια  
*stackable baskets, they can used as risser for trays or baskets*



\*27.30413 καλάθι οβάλ  
*oval basket*  
30x14 cm | 12 cm  
pack: 1





## drawer set

APS



διανεμητής ψωμιού, inox σκελετός μαύρος με ακρυλικό συρτάρι και ξύλινο δίσκο κοπής με δίσκο για ψίχουλα

*bread roll dispenser, stainless steel, black, with acrylic lid and crumb tray*

\*27.00910 35,4x32,5 cm | 42 cm  
pack: 1



\*27.11949 θήκη μαχαιροπίρουνων ξύλινη με καπάκι, 4 θέσεων (26x11,5 cm)  
*cutlery box with cover acacia wood nature, 4 compartments (26x11,5 cm) 51x28 cm | 14,5 cm*  
pack: 1

## «Bread Buffet»

APS



27.00953 δίσκος κοπής ξύλινος  
*cutting board*  
52x34 cm | 2 cm  
pack: 1



27.00959 καλάθι | *basket*  
34x26 cm | 12,5 cm  
pack: 1

27.00954 καλάθι | *basket*  
34x26 cm | 20 cm  
pack: 1

27.83615 δίσκος μελαμίνης αντιολισθητικός,  
*melamine tray (non-slip feet)*  
59,5x35,5 cm | 3,5 cm  
pack: 1

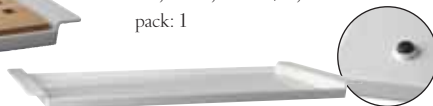

APS

δίσκος κοπής από ξύλο ακακίας με αποσπώμενη σχάρα και αντιολισθητικά πόδια  
*cutting board GN 1/1, acacia wood with bread crump shelf, anti slip-feet*

\*27.00883 47,5x32 cm | 2 cm  
pack: 1

\*27.00884 53x32,5 cm | 2 cm  
pack: 1

\*27.00885 60x40 cm | 2 cm  
pack: 1



APS

\*27.00886 ξύλινος δίσκος κοπής με αποσπώμενη σχάρα και αντιολισθητικά πόδια  
*wooden cutting board with bread crump shelf, 4 non-slip-feet*  
48x34 cm | 3,5 cm  
pack: 1



HENDI

30.41601 δίσκος κοπής με αποσπώμενη σχάρα  
*wooden cutting board with bread crump shelf*  
47,5x32,2 cm | 2 cm  
pack: 1



για ψωμιέρες επιτραπέζιες ανατρέξτε

σελίδα 318-321  
BUFFET - SERVICE

## σιρογγυλά καλάθια | round baskets

HENDI



καλάθι ψωμιού στρογγυλό polyrattan ενισχυμένο με inox πλαίσιο  
*bread basket, reinforced with a stainless-steel wire frame*

30.41853 ανοιχτόχρωμο | *natural*  
40 cm | 9 cm  
pack: 1



30.41862 μαύρο | *black*  
40 cm | 9 cm  
pack: 1



30.41863 καφέ | *brown*  
40 cm | 9 cm  
pack: 1



HENDI

## καλάθια GN | GN baskets polyrattan

30.41820	GN 1/1	(53x32,5 cm   6,5 cm)	pack: 1
30.41825	GN 1/2	(32,5x26,5 cm   6,5 cm)	pack: 1
30.41826	GN 1/3	(32,5x17,6 cm   6,5 cm)	pack: 1
30.41828	GN 1/4	(26,5x16,2 cm   6,5 cm)	pack: 1
30.41829	GN 1/6	(17,6x16,2 cm   6,5 cm)	pack: 1
30.41830	GN 2/3	(32,5x35,4 cm   6,5 cm)	pack: 1

## polyrattan καλάθια | baskets

HENDI



30.40994 καλάθι ψωμιού, οβάλ, PP  
*bread basket, oval*  
38x27 | 9 cm  
pack: 1

## polyrattan «GN line»

APS

καλάθι καφέ σκούρο | *basket dark brown*

\*27.40291 GN 1/1  
53x32,5 cm | 6,5 cm  
pack: 1

\*27.40293 GN 1/1  
53x32,5 cm | 10 cm  
pack: 1

\*27.40290 GN 1/2  
32,5x26,5 cm | 6,5 cm  
pack: 1

\*27.40292 GN 1/2  
32,5x26,5 cm | 10 cm  
pack: 1

\*27.40225 GN 1/4  
26,5x16,2 cm | 6,5 cm  
pack: 1

\*27.40245 GN 1/4  
26,5x16,2 cm | 10 cm  
pack: 1

\*27.40223 GN 1/3  
32,5x17,5 cm | 6,5 cm  
pack: 1

\*27.40243 GN 1/3  
32,5x17,5 cm | 10 cm  
pack: 1



APS

καλάθια μπεζ | *baskets beige, GN 1/1*  
\*27.40220 53x32,5 cm | 6,5 cm  
pack: 1

27.40240 53x32,5 cm | 10 cm  
pack: 1



καλάθια μπεζ | *baskets beige, GN 1/2*  
\*27.40222 32,5x26,5 cm | 6,5 cm  
pack: 1

\*27.40242 32,5x26,5 cm | 10 cm  
pack: 1

HENDI



30.40993 καλάθι ψωμιού GN 1/1  
*bread basket, GN 1/1*  
53x32 | 9 cm  
pack: 1

30.40992  
σετ παρουσίασης ψωμιού  
βάση χρωμίου και  
δύο καλάθια PP  
*bread basket display*  
(*rack + 2 PP baskets*)  
36x28 | 31,5 cm  
pack: 1

HENDI



παρουσίαση ψωμιού | *buffet bread baskets*



**27.50205** καλάθι ψωμιού, στρογγυλό επικλινές  
*bread basket, sloping round polyrattan*  
31/37 cm | 12 cm  
pack: 1



**27.50105** καλάθια ψωμιού, στρογγυλά επικλινή  
*bread basket, sloping round, polyrattan*  
42 cm | 18,5 cm  
pack: 1

**27.50110** 46 cm | 18,5 cm  
pack: 1



**27.50300** καλάθια ψωμιού, επικλινή  
*bread basket, sloping, polyrattan*  
30x40 cm | 16/27 cm  
pack: 1



**27.50305** 45x40 cm | 16/27 cm  
pack: 1

**\*27.50310** 60x40 cm | 16/27 cm  
pack: 1

καλάθια | *baskets*



**27.40137** καλάθια ψωμιού, οβάλ, PP  
διατίθενται σε μπεζ και καφέ  
*bread baskets, oval available in beige and brown*  
23x17 | 8 cm  
pack: 1

**\*27.40139** 28,5x17 | 8,5 cm  
pack: 1



**27.40140** καλάθι ψωμιού ορθογώνιο, PP  
διατίθενται σε μπεζ και καφέ  
*bread basket, rectangular available in beige and brown*  
23x17 | 8 cm  
pack: 1



σε 4 χρώματα

**\*27.50800** καλάθι ψωμιού, οβάλ  
*bread basket, oval polyrattan*  
25x19 cm | 6,5 cm  
pack: 1

καλάθι μπακετών | *baguette basket*



**27.40198** καλάθι μπακετών,  
*baguette basket, polyrattan*  
μπεζ | beige  
35 cm | 25/42 cm  
pack: 1



**30.41806** καλάθι μπακετών,  
*baguette basket, polyrattan*  
μπεζ | beige  
30,5x32 cm | 35 cm  
pack: 1



**\*27.50500** καλάθια για μπαγκέτες, στρογγυλά  
*baguette baskets, polyrattan*  
μπεζ | beige  
28/30 cm | 38 cm  
pack: 1

**\*27.50501** καφέ | brown  
28/30 cm | 38 cm  
pack: 1

καλάθια αυγών | *eggs baskets*



**27.30299** καλάθια αυγών, ξύλινα,  
με θερμομονωτική επένδυση  
*eggs baskets, willow, stable, for around 20 eggs, keeps eggs warm*  
φυσικό | natural  
26 cm | 17 cm  
pack: 1



**27.40299** σκούρο | dark wood  
26 cm | 17 cm  
pack: 1





\*27.40149 καλάθι ψωμιού, inox/PP στρογγυλό, ενισχυμένο  
bread basket with stainless steel wire frame  
40 | 12,5 cm  
pack: 1

27.18388 καπάκι roll-top | roll-top cover,  
38 | 20 cm  
pack: 1



βάση παρουσίασης, ξύλινη, πτυσσόμενη, για 3 καλάθια  
3-tier wood stand, foldable for baskets

για καλάθια 40144 (39 cm) & 40240 (GN 1/1)

27.33232 30,5 cm | 59 cm  
pack: 1



καλάθι ψωμιού στρογγυλό polyrattan  
ενισχυμένο με inox πλαίσιο  
bread basket,  
reinforced with a stainless-steel wire frame

30.41853 ανοιχτόχρωμο | natural  
40 cm | 9 cm  
pack: 1



30.41805 καπάκι roll-top  
roll-top cover,  
40,5 | 23 cm  
pack: 1



27.40144 καλάθι στρογγυλό rattan  
round rattan basket  
39 cm | 10 cm  
pack: 1



27.40240 καλάθι παραλλ/μο GN 1/1  
basket rectangle  
53x32,5 cm | 10 cm  
pack: 1

καλάθι ψωμιού με καπάκι roll-top, PP/PC, GN 2/3  
bread basket with roll-top cover

30.40991  
36,5x33,5 | 24,5 cm  
pack: 1

καπάκι roll-top, PC  
roll-top PC cover

30.42029  
36,5x33,5 | 17,5 cm  
pack: 1



polyrattan «Economy»

καλάθια ψωμιού ενισχυμένα με ανοξείδωτο σύρμα  
για μεγαλύτερη σταθερότητα, χρωμίου/polyrattan  
buffet baskets, very solid with st. steel wire frame chrome/polyrattan



καλάθι σκούρο, χωρίς καπάκι, GN 1/1  
basket dark brown, without cover, GN 1/1  
27.40295 40 cm | 10 cm  
pack: 1

καπάκι roll-top SAN - λαβή χρωμίου  
roll top cover with chrome plated handle  
27.18388 38 cm | 20 cm  
pack: 1



καλάθι σκούρο, χωρίς καπάκι, GN 1/1  
basket dark brown, without cover, GN 1/1  
27.40294 53x32,5 cm | 8 cm  
pack: 1

καπάκι roll-top, PC με λαβή χρωμίου  
roll top cover with chrome plated handle  
27.11010 53x32,5 cm | 17 cm  
pack: 1



## «Window» stand

στάντ παρουσίασης ξύλινο,  
δέχεται δίσκους GN 1/3  
oak wood oiled buffet stand  
for GN 1/3 trays

27.11740 35,5x19 cm | 37 cm  
pack: 1

δίσκος GN 1/3 πάχους 1,5 cm  
GN 1/3 tray; 1,5 cm thickness

27.84187 λευκός  
pack: 1

\*27.84197 μαύρος  
pack: 1



## γέφυρα μπουφέ | buffet bridge

γέφυρα μπουφέ από ξύλο ακακίας  
buffet bridge from acacia wood

\*27.33285 45x17 cm | 22 cm  
pack: 1

\*27.33286 70x17 cm | 22 cm  
pack: 1



## βάσεις ακακίας GN | acacia GN risers

βάσεις παρουσίασης GN  
από ξύλο ακακίας (δέχονται και καπάκια)  
acacia GN buffet risers (also receive lids)

34.60255 GN 1/4  
26,5x16,3 cm | 10 cm  
pack: 1

34.60254 GN 1/3  
32,5x17,6 cm | 12 cm  
pack: 1

34.60253 GN 1/2  
32,5x26,5 cm | 15 cm  
pack: 1



## «Birdcage»

27.33206 service stand μεταλλικό  
με 2 δίσκους  
από ξύλο ακακίας (25 cm)  
service metal stand  
with 2 acacia wood panels  
26 cm | 54 cm  
pack: 1



## service stands

- 27.30336 service σταντ μεταλλικό με 2 μεταλλικά καλάθια και 2 ξύλινους δίσκους  
*2-tier service metal stand with 2 removable baskets of black metal and 2 boards of oiled acacia wood*  
 31x17 cm | 37,5 cm  
 pack: 1



## service σταντ

- 27.30339 service σταντ μεταλλικό με 2 ξύλινους δίσκους ακακίας και 8 ταμπελάκια  
*2-tier service metal stand with 2 removable trays made of accacia wood and 8 labelling plates*  
 35,5x21 cm | 40 cm  
 pack: 1



## καλάθι μεταδιδικό

- 27.30335 διπλό μεταλλικό καλάθι με ξύλινο χέρι  
 κάτω καλάθι: 26 cm | 8 cm, επάνω καλάθι: 22 cm | 6 cm  
*2-tier metall basket tagère wooden handle, baskets made of metal, lower basket: 26 cm | 8 cm, upper basket: 22 cm | 6 cm*  
 26 cm | 48 cm  
 pack: 1



## service σταντ «Iron»

- 27.30334 service σταντ μεταλλικό με 2 ξύλινους δίσκους ακακίας και κρεμαστό ταμπελάκι  
*2-tier service metal stand with 2 removable trays made of accacia wood and inscription label*  
 47x30 cm | 44 cm  
 pack: 1





βάσεις από ξύλο ακακίας | acacia wood risers



APS

βάσεις παρουσίασης «Acacia Mini»  
από ξύλο ακακίας  
*mini acacia cake stands*

\*27.33291 13 cm | 9 cm  
pack: 1



APS

βάσεις παρουσίασης «Acacia»  
από ξύλο ακακίας  
*acacia cake stands*

\*27.33292 24 cm | 8 cm  
pack: 1

\*27.33293 24 cm | 16 cm  
pack: 1

βάσεις παρουσίασης «Acacia»  
από ξύλο ακακίας  
*acacia cake stands*

27.33294 33 cm | 8 cm  
pack: 1

27.33295 33 cm | 16 cm  
pack: 1

βάσεις παρουσίασης «Acacia»  
από ξύλο ακακίας  
*acacia cake stands*

\*27.33296 38,5 cm | 8 cm  
pack: 1

\*27.33297 38,5 cm | 16 cm  
pack: 1

«Acacia» stand

APS

27.15623  
σταντ από  
ξύλο ακακίας GN 2/4  
*acacia wood stand*  
53x16,2 cm | 20 cm  
pack: 1

27.11044  
καπάκι PC, GN 2/4  
*GN 2/4 cover, PC*  
53x16,2 cm | 10,5 cm  
pack: 1



καπάκια PC covers

APS



καπάκια PC | *PC covers*

27.06519 21 cm | 17 cm  
pack: 1

27.06520 30 cm | 22 cm  
pack: 1

27.06521 36 cm | 27 cm  
pack: 1



## «Superbox»



τελάρα 2 όψεων | reversible boxes GN

\*27.11620 GN 1/1, φυσικό χρώμα  
55,5x35 cm | 10,5 cm  
pack: 1



\*27.11626 GN 1/1, wenge  
55,5x35 cm | 10,5 cm  
pack: 1



\*27.11715 GN 1/1, vintage  
55,5x35 cm | 10,5 cm  
pack: 1



\*27.11623 GN 2/4, φυσικό χρώμα  
55,5x18,5 cm | 10,5 cm  
pack: 1



\*27.11629 GN 2/4, wenge  
55,5x18,5 cm | 10,5 cm  
pack: 1



\*27.11718 GN 2/4, vintage  
55,5x18,5 cm | 10,5 cm  
pack: 1



\*27.11621 GN 1/2, φυσικό χρώμα  
35x29 cm | 10,5 cm  
pack: 1



\*27.11627 GN 1/2, wenge  
35x29 cm | 10,5 cm  
pack: 1



\*27.11716 GN 1/2, vintage  
35x29 cm | 10,5 cm  
pack: 1



\*27.11622 GN 1/4, φυσικό χρώμα  
29x18,5 cm | 10,5 cm  
pack: 1



\*27.11628 GN 1/4, wenge  
29x18,5 cm | 10,5 cm  
pack: 1



\*27.11717 GN 1/4, vintage  
29x18,5 cm | 10,5 cm  
pack: 1

Νέα σειρά buffet «Superbox». Ξύλινα τελάρα σε 3 χρώματα και 4 μεγέθη GN. Στοιβάζονται χωρίς να γλιστρούν, χρησιμοποιούνται και από τις δύο πλευρές τους αλλά και κάθετα. Συνδυάστε τα με δίσκους μελαμίνης ή φυσικής πέτρας και δημιουργείτε πολλούς όμορφους και χρηστικούς σχηματισμούς στο μπουφέ σας.

*The stackable and non-slip reversible boxes can be connected to flat GN trays and can also be used individually. Different and individual buffet sceneries can be built up.*



Ξύλινα «τελάρα» από ξύλο ακακίας acacia «Holzbox»

\*27.11721 GN 1/1  
φυσικό χρώμα | natural  
55,5x35 cm | 20 cm  
pack: 1



\*27.11723 GN 1/1  
wenge  
55,5x35 cm | 20 cm  
pack: 1



\*27.11722 GN 1/2  
φυσικό χρώμα | natural  
35x29 cm | 20 cm  
pack: 1



\*27.11724 GN 1/2  
wenge  
35x29 cm | 20 cm  
pack: 1







«Emma»

APS



μπολ | *bowl*  
7,5 cm | 3,5 cm (6 cl)

27.85100 γκρι | *gray*  
pack: 1

27.85101 πράσινο | *green*  
pack: 1

27.85103 κόκκινο | *red*  
pack: 1



δίσκος | *tray* GN 1/4  
26,5x16,2 cm | 3 cm

27.85120 γκρι | *gray*  
pack: 1

27.85121 πράσινο | *green*  
pack: 1

27.85123 κόκκινο | *red*  
pack: 1



μπολ | *bowl*  
14 cm | 6,5 cm (50 cl)

27.85104 γκρι | *gray*  
pack: 1

27.85105 πράσινο | *green*  
pack: 1

27.85107 κόκκινο | *red*  
pack: 1



δίσκος | *tray* GN 1/2  
32,5x26,5 cm | 3 cm

27.85124 γκρι | *gray*  
pack: 1

27.85125 πράσινο | *green*  
pack: 1

27.85127 κόκκινο | *red*  
pack: 1



μπολ | *bowl*  
23 cm | 10,5 cm (2,3 lt)

27.85108 γκρι | *gray*  
pack: 1

27.85109 πράσινο | *green*  
pack: 1

27.85111 κόκκινο | *red*  
pack: 1



μπολ | *bowl* GN 1/4  
26,5x16,2 cm | 7,5 cm

27.85128 γκρι | *gray*  
pack: 1

27.85129 πράσινο | *green*  
pack: 1

27.85131 κόκκινο | *red*  
pack: 1



πίατο | *plate*  
32 cm | 3,5 cm

27.85112 γκρι | *gray*  
pack: 1

27.85113 πράσινο | *green*  
pack: 1

27.85115 κόκκινο | *red*  
pack: 1



μπολ | *bowl* GN 1/2  
32,5x26,5 cm | 7,5 cm

27.85132 γκρι | *gray*  
pack: 1

27.85133 πράσινο | *green*  
pack: 1

27.85135 κόκκινο | *red*  
pack: 1



πλατέλα | *platter*  
40,5 cm | 5,5 cm



27.85116 γκρι | *gray*  
pack: 1

27.85117 πράσινο | *green*  
pack: 1

27.85119 κόκκινο | *red*  
pack: 1



	<p>*27.85060 μπολ   <i>bowl</i> 22,5 cm   4,5 cm 0,8 lt pack: 1</p>		<p>*27.85063 πιάτο   <i>plate</i> 21 cm   3 cm pack: 1</p>
	<p>*27.85062 μπολ   <i>bowl</i> 30 cm   7 cm 2,2 lt pack: 1</p>		<p>*27.85064 πιάτο   <i>plate</i> 26 cm   3 cm pack: 1</p>
	<p>*27.85071 μπολ   <i>bowl</i> 19,5x19,5 cm   8 cm 1,5 lt pack: 1</p>		<p>*27.85065 πιάτο   <i>plate</i> 33 cm   3,5 cm pack: 1</p>
	<p>*27.85072 μπολ   <i>bowl</i> 25x25 cm   11 cm 3,5 lt pack: 1</p>		<p>*27.85067 δίσκος   <i>tray</i> GN 1/1 53x32,5 cm   2,5 cm pack: 1</p>
	<p>*27.85069 μπολ   <i>bowl</i> 16 cm   6 cm 0,5 lt pack: 1</p>		<p>*27.85068 δίσκος   <i>tray</i> GN 1/2 32,5x26,5 cm   2,5 cm pack: 1</p>
	<p>*27.85070 μπολ   <i>bowl</i> 19 cm   6 cm 0,9 lt pack: 1</p>		
	<p>*27.85061 μπολ   <i>bowl</i> 24 cm   9 cm 1,7 lt pack: 1</p>		

	<p>μπολ στρογγυλό   <i>round bowl</i> 27.84107 5 cl (8,5 cm   2,5 cm) pack: 1</p>		<p>πιατέλες «φύλλο»   <i>trays leaf</i> 27.84100 25,5x14 cm   5,5 cm pack: 1</p>
	<p>μπολ στρογγυλό   <i>round bowl</i> 27.84108 4 cl (11,5 cm   3 cm) pack: 1</p>		<p>27.84101 36x19 cm   8 cm pack: 1</p>
	<p>μπολ στρογγυλό   <i>round bowl</i> 27.84109 20 cl (11,5 cm   5,5 cm) pack: 1</p>		<p>δίσκος   <i>tray</i> *27.84104 22,5x15 cm   2 cm pack: 1</p>
	<p>μπολ στρογγυλό   <i>round bowl</i> *27.84110 30 cl (14 cm   6 cm) pack: 1</p>		<p>*27.84105 27,5x11 cm   3 cm pack: 1</p>
	<p>*27.84111 80 cl (19 cm   8 cm) pack: 1</p>		<p>*27.84106 δίσκος   <i>tray</i> 26,5x16,5 cm   4 cm pack: 1</p>
	<p>*27.84112 1 lt (21 cm   8,5 cm) pack: 1</p>		<p>*27.84119 δίσκος   <i>tray</i> 32,5x23,5 cm   4,5 cm pack: 1</p>
	<p>*27.84113 1,4 lt (24 cm   9,5 cm) pack: 1</p>		
	<p>μπολ στρογγυλό   <i>round bowl</i> 27.84174 2 lt (30,5 cm   8,5 cm) pack: 1</p>		
	<p>*27.84103 δίσκος   <i>tray</i> 14,5x14,5 cm   2 cm pack: 1</p>		





«Frida»



μπολ επικλινές | bowl, 1 lt  
21 cm | 7/8,5 cm  
\*27.84920 λευκό/ξύλο | white/wood  
pack: 1  
\*27.84921 μαύρο/ξύλο | black/wood  
pack: 1



μπολ επικλινές | bowl, 1,6 lt  
25 cm | 8/11 cm  
\*27.84922 λευκό/ξύλο | white/wood  
pack: 1  
\*27.84923 μαύρο/ξύλο | black/wood  
pack: 1



στάντ για μπολ και δίσκους  
stand for bowls and trays

\*27.84926 λευκό | white  
16,5 cm | 8 cm  
pack: 1  
\*27.84927 μαύρο | black  
16,5 cm | 8 cm  
pack: 1  
\*27.84928 λευκό | white  
16,5 cm | 12 cm  
pack: 1  
\*27.84929 μαύρο | black  
16,5 cm | 12 cm  
pack: 1



δίσκος επικλινής | tray  
22,5 cm | 1,5/2,5 cm  
\*27.84941 λευκό/ξύλο | white/wood  
pack: 1  
\*27.84942 μαύρο/ξύλο | black/wood  
pack: 1



δίσκος επικλινής | tray  
31,5 cm | 1,5/2,5 cm  
\*27.84943 λευκό/ξύλο | white/wood  
pack: 1  
\*27.84944 μαύρο/ξύλο | black/wood  
pack: 1



καπάκια PC | PC covers



27.06519 21 cm | 17 cm  
pack: 1  
27.06520 30 cm | 22 cm  
pack: 1  
27.06521 36 cm | 27 cm  
pack: 1



δίσκος επικλινής | tray  
38 cm | 1,5/2,5 cm  
\*27.84945 λευκό/ξύλο | white/wood  
pack: 1  
\*27.84946 μαύρο/ξύλο | black/wood  
pack: 1

	<p>μπολ   <i>bowl</i> 0,25 lt 12,5 cm   4,5 cm</p> <p>27.84605 λευκό/ξύλο   <i>white/wood</i> pack: 1</p> <p>27.84606 μαύρο/ξύλο   <i>black/wood</i> pack: 1</p>
	<p>μπολ   <i>bowl</i> 0,44 lt 15 cm   5,5 cm</p> <p>*27.84607 λευκό/ξύλο   <i>white/wood</i> pack: 1</p> <p>*27.84608 μαύρο/ξύλο   <i>black/wood</i> pack: 1</p>
	<p>μπολ   <i>bowl</i> 1,2 lt 20 cm   7,5 cm</p> <p>*27.84609 λευκό/ξύλο   <i>white/wood</i> pack: 1</p> <p>*27.84610 μαύρο/ξύλο   <i>black/wood</i> pack: 1</p>
	<p>μπολ   <i>bowl</i> 2,2 lt 22 cm   10,5 cm</p> <p>*27.84611 λευκό/ξύλο   <i>white/wood</i> pack: 1</p> <p>*27.84612 μαύρο/ξύλο   <i>black/wood</i> pack: 1</p>
	<p>μπολ   <i>bowl</i> 3,4 lt 26,5 cm   10,5 cm</p> <p>*27.84613 λευκό/ξύλο   <i>white/wood</i> pack: 1</p> <p>*27.84614 μαύρο/ξύλο   <i>black/wood</i> pack: 1</p>



	<p>μπολ   <i>bowl</i> 10 cl 8,5 cm   3,5 cm</p> <p>27.84930 λευκό/ξύλο   <i>white/wood</i> pack: 1</p>
	<p>μπολ   <i>bowl</i> 1,8 lt 21,5 cm   7,5 cm</p> <p>*27.84932 λευκό/ξύλο   <i>white/wood</i> pack: 1</p> <p>*27.84933 μαύρο/ξύλο   <i>black/wood</i> pack: 1</p>
	<p>μπολ   <i>bowl</i> 4,7 lt 30 cm   9,5 cm</p> <p>*27.84934 λευκό/ξύλο   <i>white/wood</i> pack: 1</p> <p>*27.84935 μαύρο/ξύλο   <i>black/wood</i> pack: 1</p>





δίσκοι | trays GN  
 27.84601 GN 1/1  
 53x32,5 cm | 2 cm  
 pack: 1  
 27.84602 GN 1/2  
 32,5x26,5 cm | 2 cm  
 pack: 1  
 \*27.84603 GN 1/4  
 26,5x16,2 cm | 2 cm  
 pack: 1  
 \*27.84604 GN 2/4  
 53x16,2 cm | 2 cm  
 pack: 1



δίσκος | tray GN 1/4  
 26,5x16,2 cm | 3 cm  
 \*27.84595 λευκό/ξύλο | white/wood  
 pack: 1  
 \*27.84596 μαύρο/ξύλο | black/wood  
 pack: 1  
 δίσκος | tray GN 1/2  
 35,5x26 cm | 3 cm  
 \*27.84598 λευκό/ξύλο | white/wood  
 pack: 1  
 \*27.84599 μαύρο/ξύλο | black/wood  
 pack: 1



\*27.84938 δίσκος 3 θέσεων (5,4 cm)  
 tray with 3 holes (5,4 cm)  
 30x8,5 cm | 1 cm  
 pack: 1



\*27.85140 δίσκος μαύρο/ξύλο  
 trays black/wood  
 41x18 cm | 2,3 cm  
 pack: 1



σετ δίσκος με 3 μπολ (10 cl)  
 set of tray with 3 bowls (10 cl)  
 30x8,5 cm | 4,5 cm

\*27.84939 λευκό/ξύλο | white/wood  
 pack: 1  
 \*27.84940 μαύρο/ξύλο | black/wood  
 pack: 1



δίσκος | tray  
 32x35 cm  
 \*27.84615 λευκό/ξύλο | white/wood  
 pack: 1  
 27.84616 μαύρο/ξύλο | black/wood  
 pack: 1



δίσκος GN λευκό/ξύλο |  
 trays GN white/wood  
 27.84985 GN 1/1  
 53x32,5 cm | 1,5 cm  
 δέχεται καπάκι  
 27.11010 & 27.11042  
 suitable for cover  
 27.11010 & 27.11042  
 pack: 1  
 \*27.84987 GN 1/2  
 35,5x29 cm | 1,5 cm  
 δέχεται καπάκι 27.11041  
 suitable for cover 27.11041  
 pack: 1

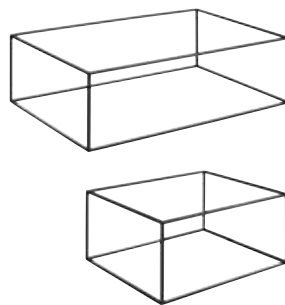

σταντ μεταλλικό | buffet stand  
 \*27.15504 μαύρο | black  
 53x32,5 cm | 16,2 cm  
 pack: 1  
 \*27.15505 μαύρο | black  
 32,5x26,5 cm | 16,2 cm  
 pack: 1

















	<p>μπολ   <i>bowl</i> GN 1/9 - 0,5 lt 17,6x10,8 cm   5,5 cm</p> <p>27.84555 λευκό/ξύλο   <i>white/wood</i> pack: 1</p> <p>27.84556 μαύρο/ξύλο   <i>black/wood</i> pack: 1</p>		<p>μπολ   <i>bowl</i>, 37 cl 12,5x12,5 cm   4,5 cm</p> <p>27.84936 λευκό/ξύλο   <i>white/wood</i> pack: 1</p> <p>27.84937 μαύρο/ξύλο   <i>black/wood</i> pack: 1</p>
	<p>μπολ   <i>bowl</i> GN 1/4 - 1,8 lt 26,5x16,2 cm   7,5 cm</p> <p>27.84586 λευκό/ξύλο   <i>white/wood</i> pack: 1</p> <p>27.84587 μαύρο/ξύλο   <i>black/wood</i> pack: 1</p>		<p>μπολ   <i>bowl</i> 0,85 lt 16,5x16,5 cm   5,5 cm</p> <p>27.84558 λευκό/ξύλο   <i>white/wood</i> pack: 1</p> <p>27.84559 μαύρο/ξύλο   <i>black/wood</i> pack: 1</p>
	<p>μπολ   <i>bowl</i> GN 1/2 - 4 lt 32,5x26,5 cm   7,5 cm</p> <p>*27.84589 λευκό/ξύλο   <i>white/wood</i> pack: 1</p> <p>*27.84590 μαύρο/ξύλο   <i>black/wood</i> pack: 1</p>		<p>μπολ   <i>bowl</i> 2,65 lt 25x25 cm   7,5 cm</p> <p>27.84561 λευκό/ξύλο   <i>white/wood</i> pack: 1</p> <p>27.84562 μαύρο/ξύλο   <i>black/wood</i> pack: 1</p>
	<p>μπολ   <i>bowl</i> GN 2/4 - 3,65 lt 53x16,2 cm   7,5 cm</p> <p>*27.84564 λευκό/ξύλο   <i>white/wood</i> pack: 1</p> <p>*27.84565 μαύρο/ξύλο   <i>black/wood</i> pack: 1</p>		<p>μπολ   <i>bowl</i> GN 1/6, 1 lt 17,6x16,2 cm   7,5 cm</p> <p>27.84583 λευκό/ξύλο   <i>white/wood</i> pack: 1</p> <p>27.84584 μαύρο/ξύλο   <i>black/wood</i> pack: 1</p>
			<p>μπολ   <i>bowl</i> 3,5 lt 25x25 cm   12 cm</p> <p>27.84592 λευκό/ξύλο   <i>white/wood</i> pack: 1</p> <p>27.84593 μαύρο/ξύλο   <i>black/wood</i> pack: 1</p>



## Dark Wave



	<p>δίσκοι   trays GN</p> <p>*27.84900 GN 1/1 53x32,5 cm   2 cm pack: 1</p>		<p>*27.84908 πιάτο ρηχό   plate 22 cm   2 cm pack: 1</p>
	<p>*27.84901 GN 1/2 32,5x26,5 cm   2 cm pack: 1</p>		<p>*27.84909 πιάτο ρηχό   plate 27 cm   2,5 cm pack: 1</p>
	<p>*27.84902 GN 1/3 32,5x17,6 cm   2 cm pack: 1</p>		<p>*27.84910 μπόλ   bowl 17,5 cm   5 cm pack: 1</p>
	<p>*27.84903 GN 2/4 53x16,2 cm   2 cm pack: 1</p>		<p>*27.84911 μπόλ   bowl 22,5 cm   5 cm pack: 1</p>
	<p>*27.84904 δίσκος   tray 14x14 cm   2 cm pack: 1</p>		<p>*27.84912 μπόλ   bowl 32 cm   3,5 cm pack: 1</p>
	<p>*27.84905 δίσκος   tray 23x10,5 cm   1,5 cm pack: 1</p>		<p>*27.84913 μπόλ   bowl 40,5 cm   5,5 cm pack: 1</p>
	<p>*27.84906 δίσκος   tray 29x12 cm   1,5 cm pack: 1</p>		<p>*27.84914 μπόλ   bowl 18x18 cm   10 cm pack: 1</p>
	<p>*27.84907 πιάτο ρηχό   plate 14,5 cm   1,5 cm pack: 1</p>		<p>*27.84915 μπόλ   bowl 23x23 cm   11x5 cm pack: 1</p>

	<p>δίσκοι   trays GN</p> <p>*27.85020 GN 1/1 53x32,5 cm   1,5 cm pack: 1</p> <p>*27.85021 GN 1/2 32,5x26,5 cm   1,5 cm pack: 1</p> <p>*27.85022 GN 1/3 32,5x17,5 cm   1,5 cm pack: 1</p> <p>*27.85023 GN 2/4 53x16,2 cm   1,5 cm pack: 1</p>		<p>*27.85026 μπολ   bowl 18 cm   3 cm pack: 1</p>
			<p>*27.85029 μπολ   bowl 20,5 cm   6,5 cm pack: 1</p>
			<p>*27.85030 μπολ   bowl 31 cm   8 cm pack: 1</p>
	<p>*27.85025 δίσκος   platters 23,5x13,5 cm   1,5 cm pack: 1</p>		<p>*27.85024 μπολ   bowl 34x15,5 cm   4 cm pack: 1</p>
	<p>πλατέλες   platters</p> <p>*27.85027 22 cm   2 cm pack: 1</p> <p>*27.85028 27 cm   2 cm pack: 1</p>		<p>δίσκοι   trays</p> <p>*27.85033 21,5 cm   2,5 cm pack: 1</p> <p>*27.85034 30,5 cm   3,5 cm pack: 1</p>
	<p>πλατέλες   platters</p> <p>*27.85031 32 cm   3,5 cm pack: 1</p> <p>27.85032 40,5 cm   5 cm pack: 1</p>		<p>*27.85035 37,5 cm   4 cm pack: 1</p>







## «Arabesque»

APS

	<p>δίσκοι GN αντιολισθητικοί <i>GN trays non-slip</i></p>		<p>*27.84684 πιάτο   <i>plate</i> 21,5 cm   2 cm pack: 1</p>
	<p>*27.84680 GN 1/1 53x32,5 cm   2 cm pack: 1</p>		<p>*27.84685 πιάτο   <i>plate</i> 26,5 cm   2 cm pack: 1</p>
	<p>*27.84681 GN 1/2 32,5x26,5 cm   2 cm pack: 1</p>		<p>*27.84687 μπολ   <i>bowl</i> 10 cm   6 cm pack: 1</p>
	<p>*27.84682 GN 1/3 32,5x17,6 cm   2 cm pack: 1</p>		<p>*27.84688 μπολ   <i>bowl</i> 16 cm pack: 1</p>
	<p>*27.84683 GN 2/4 53x16,2 cm   2 cm pack: 1</p>		<p>*27.84689 μπολ   <i>bowl</i> 20,5 cm   5,5 cm pack: 1</p>
	<p>*27.84686 πιατέλα   <i>platter</i> 38x15,5 cm   2 cm pack: 1</p>		<p>*27.84690 μπολ   <i>bowl</i> 31 cm   9 cm pack: 1</p>

## «La Vida»

	<p>πιατέλα βαθιά μωβ   <i>deep tray purple</i> *27.84165 32 cm   3,5 cm pack: 1</p>	
	<p>*27.84168 40,5 cm   5,5 cm pack: 1</p>	
	<p>πιατέλα βαθιά μπλε   <i>deep tray blue</i> *27.84161 32 cm   3,5 cm pack: 1</p>	
	<p>*27.84170 40,5 cm   5,5 cm pack: 1</p>	
	<p>πιατέλα βαθιά πράσινη   <i>deep tray green</i> *27.84171 32 cm   3,5 cm pack: 1</p>	
	<p>*27.84172 40,5 cm   5,5 cm pack: 1</p>	



«Stone Art»

	<p><b>27.84523</b> μπολ   bowl, 7 cl 8 cm   3 cm pack: 1</p> <p><b>27.84524</b> μπολ   bowl, 30 cl 12 cm   6 cm pack: 1</p> <p><b>27.84525</b> μπολ   bowl, 60 cl 15 cm   7,5 cm pack: 1</p>		<p><b>27.84529</b> μπολ   bowl, 0,5 lt 19x19 cm   6 cm pack: 1</p> <p><b>27.84530</b> μπολ   bowl, 1,1 lt 24x24 cm   6,5 cm pack: 1</p>
	<p><b>27.84509</b> μπολ   bowl, 15 cl 15,5 cm   2,5 cm pack: 1</p> <p><b>27.84514</b> μπολ   bowl, 60 cl 20 cm   4,5 cm pack: 1</p>		<p><b>27.84517</b> δίσκος   tray 33x32,5 cm   3 cm pack: 1</p>
	<p><b>27.84526</b> μπολ οβάλ   bowl, 60 cl 23x19 cm   6,5 cm pack: 1</p>		<p><b>27.84519</b> δίσκος   tray, GN 1/1 53x32,5 cm   1,5 cm pack: 1</p>
	<p><b>27.84528</b> μπολ οβάλ   bowl, 1,2 lt 28,5x21 cm   7,5 cm pack: 1</p>		<p><b>27.84520</b> δίσκος   tray, GN 1/2 32,5x26,5 cm   1,5 cm pack: 1</p>
	<p><b>27.84510</b> πιάτο ρηχό   plate 19 cm   2 cm pack: 1</p>		<p><b>27.84521</b> δίσκος   tray, GN 1/3 32,5x17,6 cm   1,5 cm pack: 1</p>
	<p><b>27.84511</b> πιάτο ρηχό   plate 25 cm   2 cm pack: 1</p>		<p><b>27.84522</b> δίσκος   tray, GN 2/4 53x16,2 cm   1,5 cm pack: 1</p>
	<p><b>27.84512</b> πιάτο ρηχό   plate 30 cm   2 cm pack: 1</p>		
	<p><b>27.84515</b> πιάτο βαθύ   deep plate 24,5   3,5 cm pack: 1</p>		

«Elements»



	27.84825 μπολ   <i>bowl</i> 8 cm   2 cm pack: 1		*27.84400 δίσκος   <i>tray</i> ; GN 1/1 53x32,5 cm   3,5 cm pack: 1
	27.84820 μπολ   <i>bowl</i> 9x7 cm   3 cm pack: 1		*27.84401 δίσκος   <i>tray</i> ; GN 1/2 32,5x26,5 cm   3,5 cm pack: 1
	*27.84821 μπολ   <i>bowl</i> 10,5x10,5 cm   3 cm pack: 1		*27.84402 δίσκος   <i>tray</i> ; GN 1/3 32,5x17,6 cm   3,5 cm pack: 1
	*27.84826 μπολ   <i>bowl</i> 10,5x10 cm   3 cm pack: 1		*27.84403 δίσκος   <i>tray</i> ; GN 1/4 26,5x16,2 cm   3,5 cm pack: 1
	*27.84827 μπολ   <i>bowl</i> 17,5x15,5 cm   5,5 cm pack: 1		*27.84404 δίσκος   <i>tray</i> ; GN 2/4 53x16,2 cm   3,5 cm pack: 1
	*27.84828 μπολ   <i>bowl</i> 16 cm   7 cm (0,5 lt) pack: 1		δίσκος GN   <i>trays</i> GN *27.84986 GN 1/1 53x32,5 cm   1,5 cm δέχεται καπάκι 27.11010 & 27.11042 <i>suitable for cover</i> 27.11010 & 27.11042 pack: 1
	*27.84829 μπολ   <i>bowl</i> 28 cm   12 cm (3 lt) pack: 1		27.84988 GN 1/2 35,5x29 cm   1,5 cm δέχεται καπάκι 27.11041 <i>suitable for cover</i> 27.11041 pack: 1
	*27.84822 δίσκος   <i>tray</i> 20x9,5 cm   2,5 cm pack: 1		
	*27.84824 δίσκος   <i>tray</i> 31x10,5 cm   1,5 cm pack: 1		
	*27.84823 δίσκος   <i>tray</i> 22,5x15 cm   3 cm pack: 1		
	*27.84830 μπολ   <i>bowl</i> 19x19x cm   9 cm (1,5 lt) pack: 1		
	*27.84831 μπολ   <i>bowl</i> 25x25 cm   12 cm (3,8 lt) pack: 1		

AFS

«Element look»

- 

27.84835 μπολ | bowl  
21,5 cm | 5,5/9,5 cm  
pack: 1
- 

27.84836 μπολ | bowl  
26 cm | 7/12 cm  
pack: 1
- 27.84837 μπολ | bowl  
30 cm | 8,5/14,5 cm  
pack: 1



«Moon»



σετ «Moon»  
3 μπολ μελαμίνης και  
3 ξύλινα κουτάλια  
set «Moon»  
3 melamine bowls and 3 wooden spoons

\*27.85080 μπεζ | beige  
8 cm | 7,5 cm  
0,05 lt  
pack: 1

\*27.85081 μαύρα | black  
8 cm | 7,5 cm  
0,05 lt  
pack: 1



σετ «Moon», 1 μπολ μελαμίνης και  
1 αρθρωτό καπάκι  
set «Moon», 1 bowl + 1 hinged cover

27.85082 μπεζ | beige  
19 cm | 17,5 cm  
0,8 lt  
pack: 1

27.85083 μαύρα | black  
19 cm | 17,5 cm  
0,8 lt  
pack: 1



27.85084 ανταλλακτικό καπάκι  
hinged cover with silicone  
seal  
16 cm | 1,5 cm  
pack: 1











«Bamboo»



	*27.84805 δίσκος   tray 31x10,5 cm   2 cm pack: 1		*27.84809 πιάτο οβάλ   oval plate 24x17 cm   3,5 cm pack: 1
	*27.84806 δίσκος   tray 21x13 cm   3 cm pack: 1		*27.84815 μπόλ οβάλ   oval bowl 10,5x10 cm   3 cm pack: 1
	*27.84807 δίσκος   tray 24,5x15,5 cm   3 cm pack: 1		27.84816 μπόλ οβάλ   oval bowl 27,5x15,5 cm   5,5 cm pack: 1
	*27.84808 δίσκος   tray 34,5x21,5 cm   3 cm pack: 1		27.84819 μπόλ   bowl 33x32,5 cm   3 cm pack: 1
	*27.84803 δίσκος   tray 10x10 cm   2 cm pack: 1		*27.84811 δίσκος   tray 24,5x15,5 cm   3,5 cm pack: 1
	*27.84804 δίσκος   tray 14,5x14,5 cm   2,5 cm pack: 1		*27.84812 δίσκος   tray 32,5x19 cm   4,5 cm pack: 1
	27.84817 μπόλ   bowl 18x17,5 cm   5,5 cm pack: 1		*27.84813 δίσκος   tray 40,25,5 cm   3 cm pack: 1
	27.84818 μπόλ   bowl 23x22 cm   7 cm pack: 1		*27.84814 δίσκος   tray 53x34 cm   3,5 cm pack: 1
			27.84810 δίσκος   tray 34x13 cm   3 cm pack: 1

	<p>*27.84269 δίσκος οβάλ   <i>oval tray</i> 65x26 cm   3 cm pack: 1</p>		<p>*27.84890 πιάτο ρηχό   <i>plate</i> 15 cm   1,5 cm pack: 1</p>
	<p>*27.84268 δίσκος ορθογώνιος <i>rectangular tray</i> 44x25 cm   1,5 cm pack: 1</p>		<p>*27.84891 πιάτο ρηχό   <i>plate</i> 21,5 cm   2,5 cm pack: 1</p>
	<p>δίσκος στρογγυλός   <i>round tray</i> *27.84266 35 cm   3 cm pack: 1 *27.84267 44 cm   3 cm pack: 1</p>		<p>*27.84892 πιάτο ρηχό   <i>plate</i> 27,5 cm   3 cm pack: 1</p>



\*27.84264  
δίσκος | *tray*  
44x25 cm | 1,5 cm  
pack: 1



\*27.84256  
δίσκος με χέρι | *tray with handle*  
70x26 cm | 3 cm  
pack: 1





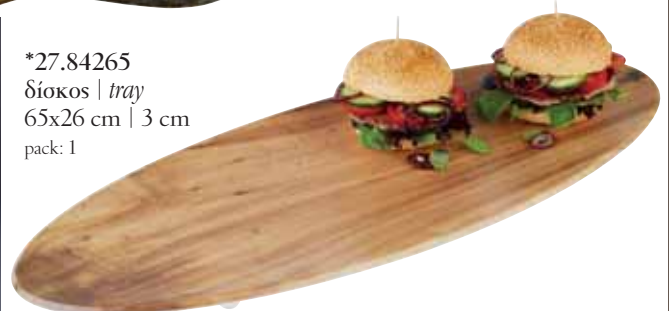



\*27.84265  
δίσκος | *tray*  
65x26 cm | 3 cm  
pack: 1









## «Aiko»

APS

	*27.84329 μπολ μαύρο   <i>black bowl</i> 7 cl - 8 cm   4 cm pack: 1
	*27.84331 μπολ μαύρο   <i>black bowl</i> 20 cl - 11,5 cm   6 cm pack: 1
	*27.84334 μπολ λευκό   <i>white bowl</i> 0,6 lt - 16 cm   7 cm pack: 1
	*27.84335 μπολ μαύρο   <i>black bowl</i> 0,6 lt - 16 cm   7 cm pack: 1
	*27.84336 μπολ λευκό   <i>white bowl</i> 1,2 lt - 20,5 cm   8 cm pack: 1
	*27.84337 μπολ μαύρο   <i>black bowl</i> 1,2 lt - 20,5 cm   8 cm pack: 1
	μπολ οβάλ   <i>oval bowl</i> *27.84327 μαύρο   <i>black</i> 26,5x19,5 cm   6 cm pack: 1

## «Halftone»





APS

	27.84130 μπολ   <i>bowl</i> , 5 cl 11,5x7 cm   4 cm pack: 1
	*27.84131 μπολ   <i>bowl</i> , 10 cl 14x8 cm   4,5 cm pack: 1
	*27.84134 μπολ   <i>bowl</i> , 35 cl 24x17,5 cm   7,5 cm pack: 1
	*27.84136 μπολ   <i>bowl</i> , 1 lt 19 cm   8,5 cm pack: 1
	*27.84124 δίσκος   <i>tray</i> 20,5x12,5 cm   3 cm pack: 1
	*27.84125 δίσκος   <i>tray</i> 24,5x15 cm   3 cm pack: 1



## «Fusion»

APS

	*27.84022 μπολ   <i>bowl</i> , 0,3 lt 11 cm   7 cm pack: 1
	*27.84023 μπολ   <i>bowl</i> , 1 lt 17 cm   8,5 cm pack: 1
	*27.84024 μπολ   <i>bowl</i> , 1,2 lt 20 cm   8 cm pack: 1
	*27.84025 δίσκος   <i>tray</i> 23,5x7,5 cm   2 cm pack: 1





	27.83721 μπολ λευκό   <i>white bowl</i> 3 cl (8 cm   1,5 cm) pack: 1
	27.83723 μπολ μαύρο   <i>black bowl</i> 3 cl (8 cm   1,5 cm) pack: 1
	*27.83946 μπολ λευκό   <i>white bowl</i> 5 cl (9x7 cm   2,5 cm) pack: 1
	*27.83947 μπολ μαύρο   <i>black bowl</i> 5 cl (9x7 cm   2,5 cm) pack: 1
	27.83725 μπολ λευκό   <i>white bowl</i> 6 cl (10,5x10,5 cm   3 cm) pack: 1
	27.83727 μπολ μαύρο   <i>black bowl</i> 6 cl (10,5x10,5 cm   3 cm) pack: 1
	*27.83718 μπολ λευκό   <i>white bowl</i> 0,2 lt (12x12 cm   4 cm) pack: 1
	*27.83720 μπολ μαύρο   <i>black bowl</i> 0,2 lt (12x12 cm   4 cm) pack: 1
	*27.83948 μπολ λευκό   <i>white bowl</i> 14x9 cm   2,5 cm pack: 1
	27.83949 μπολ μαύρο   <i>black bowl</i> 14x9 cm   2,5 cm pack: 1
	*27.83932 μπολ λευκό   <i>white bowl</i> 11,5 cm   4 cm pack: 1
	*27.83933 μπολ μαύρο   <i>black bowl</i> 11,5 cm   4 cm pack: 1
	27.83730 μπολ λευκό   <i>white bowl</i> 11x10 cm   3 cm pack: 1
	27.83732 μπολ μαύρο   <i>black bowl</i> 11x10 cm   3 cm pack: 1
	27.83726 μπολ λευκό   <i>white bowl</i> 13x11 cm   3,5 cm pack: 1
	*27.83728 μπολ μαύρο   <i>black bowl</i> 13x11 cm   3,5 cm pack: 1
	*27.83722 μπολ λευκό   <i>white bowl</i> 17,5x15,5 cm   5,5 cm pack: 1
	*27.83929 μπολ μαύρο   <i>black bowl</i> 31 cm   8,5 cm pack: 1
	*27.83712 μπολ μαύρο   <i>black bowl</i> 1,4 lt (21x21 cm   11 cm) pack: 1



	*27.84348 μπολ λευκό   <i>white bowl</i> 8 cl (10 cm   7 cm) pack: 1
	*27.84349 μπολ μαύρο   <i>black bowl</i> 8 cl (10 cm   7 cm) pack: 1
	*27.84350 μπολ λευκό   <i>white bowl</i> 15 cl (12,5 cm   8,5 cm) pack: 1
	*27.84351 μπολ μαύρο   <i>black bowl</i> 15 cl (12,5 cm   8,5 cm) pack: 1
	*27.84352 μπολ λευκό   <i>white bowl</i> 30 cl (16 cm   10 cm) pack: 1
	*27.84353 μπολ μαύρο   <i>black bowl</i> 30 cl (16 cm   10 cm) pack: 1

	*27.84355 μπολ μαύρο   <i>black bowl</i> 80 cl (22,5 cm   12,5 cm) pack: 1
	27.83742 δίσκος λευκός   <i>tray white</i> 22,5x9,5 cm   3 cm pack: 1
	27.83744 δίσκος μαύρος   <i>tray black</i> 22,5x9,5 cm   3 cm pack: 1

	*27.83738 δίσκος sushi, λευκός <i>sushi white tray</i> 22x12 cm   3 cm pack: 1
	*27.83740 δίσκος sushi, μαύρος <i>sushi black tray</i> 22x12 cm   3 cm pack: 1





## «Float»



















	27.83910 μπολ λευκό   <i>white bowl</i> 5 cl (5,5x5,5 cm   3 cm) pack: 1
	27.83911 μπολ μαύρο   <i>black bowl</i> 5 cl (5,5x5,5 cm   3 cm) pack: 1
	*27.83912 μπολ λευκό   <i>white bowl</i> 17 cl (9,5x9,5 cm   4,5 cm) pack: 1
	27.83913 μπολ μαύρο   <i>black bowl</i> 17 cl (9,5x9,5 cm   4,5 cm) pack: 1
	*27.83914 μπολ λευκό   <i>white bowl</i> 22 cl (12,5x12,5 cm   6 cm) pack: 1
	*27.83915 μπολ μαύρο   <i>black bowl</i> 22 cl (12,5x12,5 cm   6 cm) pack: 1
	27.83916 μπολ λευκό   <i>white bowl</i> 1,5 lt 19x19 cm   9,5 cm) pack: 1
	27.83917 μπολ μαύρο   <i>black bowl</i> 1,5 lt (19x19 cm   9,5 cm) pack: 1
	*27.83921 καπάκι   <i>cover</i> 19x19 cm   1,3 cm pack: 1
	27.83918 μπολ λευκό   <i>white bowl</i> 4 lt (25x25 cm   12 cm) pack: 1
	27.83919 μπολ μαύρο   <i>black bowl</i> 4 lt (25x25 cm   12 cm) pack: 1
	*27.83922 καπάκι   <i>cover</i> 25x25 cm   1,3 cm pack: 1
	*27.83900 μπολ λευκό   <i>white bowl</i> 5 cl (5,5 cm   3 cm) pack: 1
	27.83901 μπολ μαύρο   <i>black bowl</i> 5 cl (5,5 cm   3 cm) pack: 1
	*27.83908 μπολ λευκό   <i>white bowl</i> 2 lt (20,5 cm   10 cm) pack: 1
	*27.83909 μπολ μαύρο   <i>black bowl</i> 2 lt (20,5 cm   10 cm) pack: 1
	*27.83920 καπάκι 20,5 cm   1,3 cm pack: 1

## «Pure»

	μπολ   <i>bowl</i> - 5 cl (6,5x6,5 cm   4 cm) *27.84424 λευκό   <i>white</i> pack: 1
	*27.84426 μαύρο   <i>black</i> pack: 1
	μπολ   <i>bowl</i> - 14 cl (9x9 cm   4 cm) 27.83414 λευκό   <i>white</i> pack: 1
	27.83466 μαύρο   <i>black</i> pack: 1
	μπολ   <i>bowl</i> - 40 cl (12,5x12,5 cm   6,5 cm) 27.83410 λευκό   <i>white bowl</i> pack: 1
	27.83467 μαύρο   <i>black</i> pack: 1
	μπολ   <i>bowl</i> - 1,5 lt (19x19 cm   9 cm) 27.83409 λευκό   <i>white</i> pack: 1
	27.83468 μαύρο   <i>black</i> pack: 1
	μπολ   <i>bowl</i> - 3,8 lt (25x25 cm   12 cm) 27.83408 λευκό   <i>white</i> pack: 1
	27.83469 μαύρο   <i>black</i> pack: 1
	μπολ   <i>bowl</i> - 8 lt (32x32 cm   14 cm) 27.84425 λευκό   <i>white</i> pack: 1
	27.84427 μαύρο   <i>black</i> pack: 1
	μπολ   <i>bowl</i> - 2 cl (5,5 cm   4 cm) 27.83450 λευκό   <i>white</i> pack: 1
	27.83451 μαύρο   <i>black</i> pack: 1
	μπολ   <i>bowl</i> - 9 cl (9 cm   4,5 cm) 27.83419 λευκό   <i>white</i> pack: 1
	27.83452 μαύρο   <i>black</i> pack: 1
	μπολ   <i>bowl</i> - 30 cl (13 cm   6,5 cm) *27.83453 λευκό   <i>white</i> pack: 1
	*27.83454 μαύρο   <i>black</i> pack: 1
	μπολ   <i>bowl</i> - 45 cl (15 cm   7,5 cm) *27.83455 λευκό   <i>white</i> pack: 1
	*27.83456 μαύρο   <i>black</i> pack: 1
	μπολ   <i>bowl</i> - 1,25 lt (20 cm   10,5 cm) *27.83415 λευκό   <i>white</i> pack: 1
	*27.83457 μαύρο   <i>black</i> pack: 1









	μπολ λευκό στρογ.   <i>round white bowl</i> 27.83880 2 cl (6 cm   2,5 cm) pack: 1
	27.83881 5 cl (7,5 cm   3,5 cm) pack: 1
	μπολ λευκό στρογ.   <i>round white bowl</i> 27.83780 4 cl (6 cm   3,7 cm) pack: 1
	27.83782 8 cl (7,8 cm   4 cm) pack: 1
	27.83783 11 cl (8,5 cm   4,5 cm) pack: 1
	μπολ μαύρο στρογ.   <i>round black bowl</i> 27.83798 3 cl (6 cm   3,5 cm) pack: 1

	27.83696 μπολ λευκό   <i>white bowl</i> 15 cl (10 cm   4,5 cm) pack: 1
	27.83697 μπολ μαύρο   <i>black bowl</i> 15 cl (10 cm   4,5 cm) pack: 1
	27.83698 μπολ λευκό   <i>white bowl</i> 25 cl (12 cm   5,5 cm) pack: 1
	27.83699 μπολ μαύρο   <i>black bowl</i> 25 cl (12 cm   5,5 cm) pack: 1
	27.83700 μπολ λευκό   <i>white bowl</i> 50 cl (14 cm   6,5 cm) pack: 1
	27.83701 μπολ μαύρο   <i>black bowl</i> 50 cl (14 cm   6,5 cm) pack: 1
	27.83704 μπολ λευκό   <i>white bowl</i> 1,8 lt (20 cm   9,2 cm) pack: 1
	27.83705 μπολ μαύρο   <i>black bowl</i> 1,8 lt (20 cm   9,2 cm) pack: 1
	27.83702 μπολ λευκό   <i>white bowl</i> 2,5 lt (23 cm   10,5 cm) pack: 1
	27.83703 μπολ μαύρο   <i>black bowl</i> 2,5 lt (23 cm   10,5 cm) pack: 1



«Tao»

	μπολ ορθογώνιο   <i>rectangular bowl</i> *27.83639 μπολ λευκό   <i>white bowl</i> 32,5x17,5 cm   10 cm pack: 1
	*27.83640 μπολ μαύρο   <i>black bowl</i> 32,5x17,5 cm   10 cm pack: 1
	μπολ τετράγωνο   <i>square bowl</i> *27.83642 μπολ λευκό   <i>white bowl</i> 30,5x30,5x10 cm pack: 1
	*27.83643 μπολ μαύρο   <i>black bowl</i> 30,5x30,5x10 cm pack: 1
	μπολ στρογγυλό   <i>round bowl</i> *27.83648 μπολ λευκό   <i>white bowl</i> 10,5x10 cm   6,5/3 cm pack: 1
	*27.83649 μπολ μαύρο   <i>black bowl</i> 10,5x10 cm   6,5/3 cm pack: 1

	μπολ στρογγυλό   <i>round bowl</i> *27.83651 μπολ λευκό   <i>white bowl</i> 13,5x12,5 cm   8,5/4 cm pack: 1
	*27.83652 μπολ μαύρο   <i>black bowl</i> 13,5x12,5 cm   8,5/4 cm pack: 1
	*27.83654 μπολ λευκό   <i>white bowl</i> 17x16 cm   10,5/4,5 cm pack: 1
	*27.83655 μπολ μαύρο   <i>black bowl</i> 17x16 cm   10,5/4,5 cm pack: 1



# «Global buffet»





	<p>27.83799 μπολ λευκό   <i>white bowl</i> 3 lt (25,5 cm   13 cm) pack: 1</p>		<p>*27.84462 μπολ λευκό   <i>white bowl</i> 3,3 lt 44x25 cm   20 cm pack: 1</p>
	<p>27.83788 μπολ λευκό   <i>white bowl</i> 4,5 lt (32 cm   16,5 cm) pack: 1</p>		<p>*27.84623 μπολ λευκό   <i>white bowl</i> 3,2 lt 50x32 cm   17 cm pack: 1</p>
	<p>27.83789 μπολ λευκό   <i>white bowl</i> 6 lt (35 cm   17 cm) pack: 1</p>		<p>*27.84464 μπολ λευκό   <i>white bowl</i> 2,5 lt 35,5x31 cm   14 cm pack: 1</p>
	<p>27.83790 μπολ λευκό   <i>white bowl</i> 8 lt (40 cm   17,5 cm) pack: 1</p>		<p>*27.84466 μπολ μαύρο   <i>black bowl</i> 5,5 lt 46x40 cm   18,5 cm pack: 1</p>
	<p>27.83785 μπολ λευκό   <i>white bowl</i> 3 lt (32,5x32,5 cm   12 cm) pack: 1</p>		<p>μπολ λευκό   <i>white bowl</i> *27.84200 1 lt 42x19,5 cm   6,5 cm pack: 1</p>
	<p>27.84785 μπολ μαύρο   <i>black bowl</i> 3 lt (32,5x32,5 cm   12 cm) pack: 1</p>		<p>*27.84202 1,5 lt 50x23 cm   7,5 cm pack: 1</p>
	<p>27.83786 μπολ λευκό   <i>white bowl</i> 3,5 lt (35x35 cm   12,5 cm) pack: 1</p>		<p>*27.84387 μπολ μαύρο   <i>black bowl</i> 3,5 lt (36x36 cm   11 cm) pack: 1</p>
	<p>27.84786 μπολ μαύρο   <i>black bowl</i> 3,5 lt (35x35 cm   12,5 cm) pack: 1</p>		<p>*27.83587 μπολ λευκό με λαβή <i>white bowl with handle</i> 1 lt 33x24 cm   8,5 cm pack: 1</p>
	<p>27.83787 μπολ λευκό   <i>white bowl</i> 5 lt (40x40 cm   13,5 cm) pack: 1</p>		
	<p>27.84787 μπολ μαύρο   <i>black bowl</i> 5 lt (40x40 cm   13,5 cm) pack: 1</p>		



APS

«Sinus»

	<p>δίσκος   tray GN 1/1 (53x32,5 cm   2 cm)</p> <p>*27.84230 λευκός   white pack: 1</p> <p>*27.84260 μαύρος   black pack: 1</p>
	<p>δίσκος   tray GN 2/4 (53x16,2 cm   2 cm)</p> <p>*27.84231 λευκός   white pack: 1</p> <p>*27.84261 μαύρος   black pack: 1</p>
	<p>μπολ λευκό   white bowl</p> <p>*27.84229 10,5x10,5 cm   4 cm (10 cl) pack: 1</p> <p>*27.84232 21x21 cm   9 cm (1,5 lt) pack: 1</p> <p>*27.84233 25x25 cm   11 cm (2,4 lt) pack: 1</p>

APS

«Pure»

	<p>μπολ λευκό   white bowl</p> <p>*27.83497 22,5x15,5 cm   7,5 cm pack: 1</p> <p>*27.83498 38,5x15,5 cm   7,5 cm pack: 1</p> <p>*27.83499 51x15,5 cm   7,5 cm pack: 1</p>
---	---

APS

«Balance»

	<p>μπολ   bowl 14,5 cm   9 cm (40 cl)</p> <p>27.84040 λευκό   white pack: 1</p> <p>27.85040 μαύρο   black pack: 1</p>
	<p>μπολ   bowl 21 cm   13 cm (1,5 lt)</p> <p>27.84041 λευκό   white pack: 1</p> <p>27.85041 μαύρο   black pack: 1</p>
	<p>μπολ   bowl 24,5 cm   15 cm (2,5 lt)</p> <p>27.84042 λευκό   white pack: 1</p> <p>27.85042 μαύρο   black pack: 1</p>
	<p>μπολ   bowl 30 cm   19,5 cm (5 lt)</p> <p>27.84043 λευκό   white pack: 1</p> <p>27.85043 μαύρο   black pack: 1</p>

«Pure»







	<p>δίσκοι λευκοί GN   trays white GN</p> <p>27.83401 GN 1/1 53x32,5 cm   3 cm pack: 1</p> <p>27.83480 GN 1/2 32,5x26,5 cm   3 cm pack: 1</p> <p>*27.83482 GN 1/4 26,5x16,2 cm   3 cm pack: 1</p> <p>*27.83433 GN 2/4 53x16,2 cm   3 cm pack: 1</p>
	<p>δίσκοι μαύροι   trays black</p> <p>27.83479 GN 1/1 53x32,5 cm   3 cm pack: 1</p> <p>27.83490 GN 1/2 32,5x26,5 cm   3 cm pack: 1</p> <p>*27.83491 GN 1/3 32,5x17,5 cm   3 cm pack: 1</p> <p>*27.83492 GN 1/4 26,5x16,2 cm   3 cm pack: 1</p> <p>*27.83434 GN 2/4 53x16,2 cm   3 cm pack: 1</p>
	<p>δίσκοι λευκοί   trays white</p> <p>*27.83402 53x18 cm   3 cm pack: 1</p> <p>27.83403 35,5x18 cm   3 cm pack: 1</p> <p>*27.83417 30x21 cm   3 cm pack: 1</p>
	<p>δίσκοι λευκοί τετράγωνοι rectangular trays white</p> <p>*27.83407 21x21 cm   3 cm pack: 1</p> <p>*27.83406 26,5x26,5 cm   3 cm pack: 1</p> <p>27.83405 37x37 cm   3 cm pack: 1</p> <p>*27.83404 51x51 cm   3 cm pack: 1</p>



για stand  
μπολ και δίσκων

σελίδα **278-279**  
BUFFET - SERVICE

## «Gourmet»

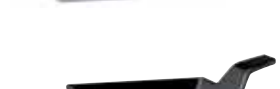
	27.84017 δίοκος   tray «Gourmet» με τρεις θέσεις (δέχεται και το μπολ 27.84018) with 3 holes (use and with bowl 27.84018) 30,5x9,5 cm   2,5 cm pack: 1
	27.84018 «Gourmet», 5 cl 7 cm   6 cm pack: 1
	*27.84220 «Casual» 29x9 cm   3 cm pack: 1
	*27.84221 «Scantic», 1 lt 26,5x10,5 cm   6,5 cm pack: 1
	*27.84222 «Scantic», 2 lt 53x10,5 cm   6,5 cm pack: 1
	πιτάκι «Flying» plate 27.83878 λευκό   white 9,5x9,5 cm   1,5/3,5 cm pack: 1
	27.83879 μαύρο   black 9,5x9,5 cm   1,5/3,5 cm pack: 1

## «Zen»



	27.83721 μπολ λευκό   white bowl 3 cl (8 cm   1,5 cm) pack: 1
	27.83723 μπολ μαύρο   black bowl 3 cl (8 cm   1,5 cm) pack: 1
	27.83725 μπολ λευκό   white bowl 6 cl (10,5x10,5 cm   3 cm) pack: 1
	27.83727 μπολ μαύρο   black bowl 6 cl (10,5x10,5 cm   3 cm) pack: 1



## κουταλάκια «Leaf» party spoons

	27.83887 λευκό   white 10x4,5 cm pack: 6
	27.83888 μαύρο   black 10x4,5 cm pack: 6
	27.83889 πράσινο   green 10x4,5 cm pack: 6

## κουταλάκια «Ming Hing» party spoons



	27.83842 κουτάλι amuse-bouche, λευκό, 11x4,5 cm pack: 6
	27.83843 κουτάλι amuse-bouche, μαύρο, 11x4,5 cm pack: 6

## κουταλάκια «Halftone» party spoons

	*27. 84158 κουτάλι amuse-bouche, λευκό/μαύρο, 5,5 cm   7 cm pack: 6
---	---



«Mini»

	27.84452 μπολ λευκό   <i>white bowl</i> 6 cl (11,5x7,5 cm   3 cm) pack: 1
	27.84456 μπολ λευκό   <i>white bowl</i> 7 cl (8,5x7 cm   6 cm) pack: 1
	27.84458 μπολ λευκό   <i>white bowl</i> 10 cl (8x8 cm   4 cm) pack: 1



«Float»

	«Float» 5 cl (5,5 cm   3 cm) *27.83900 λευκό   <i>white</i> pack: 1
	27.83901 μαύρο   <i>black</i> pack: 1
	«Float» 5 cl (5,5x5,5 cm   3 cm) 27.83910 λευκό   <i>white</i> pack: 1
	27.83911 μαύρο   <i>black</i> pack: 1
	«Pure» 2 cl (5,5 cm   4 cm) 27.83450 λευκό   <i>bowl</i> pack: 1
	27.83451 μαύρο   <i>black</i> pack: 1
	«Emma» 6 cl (7,5 cm   3,5 cm) *27.85100 γκρι   <i>gray</i> pack: 1
	*27.85101 πράσινο   <i>green</i> pack: 1
	*27.85103 κόκκινο   <i>red</i> pack: 1
	μπολ   <i>bowl</i> , 11x10 cm   3 cm 27.83730 λευκό   <i>white</i> pack: 1
	27.83732 μαύρο   <i>black</i> pack: 1

APS







κουταλάκια «Boat» party spoons

	*27.84128 λευκό/μαύρο   <i>white/black</i> 14,5x4,5 cm   4,5 cm pack: 1
	*27.84140 λευκό   <i>white</i> 14,5x4,5 cm   4,5 cm pack: 1
	*27.84141 μαύρο   <i>black</i> 14,5x4,5 cm   4,5 cm pack: 1
	*27.84142 πράσινο   <i>green</i> 14,5x4,5 cm   4,5 cm pack: 1

APS

κουταλάκια «Hong Kong» party spoons



	*27.83424 σταχτί   <i>ash</i> 13x4,5 cm pack: 6
	*27.83426 πράσινο   <i>green</i> 13x4,5 cm pack: 6
	27.83486 λευκό   <i>white</i> 13x4,5 cm pack: 6
	27.83487 μαύρο   <i>black</i> 13x4,5 cm pack: 6

## Single portioning



## «Quattro Stagioni»



γυάλινα δοχεία  
με καπάκι  
glass jars with lid



00.30123  
20 cl  
pack: 6



00.30124  
32 cl  
pack: 6



00.30126  
4 cl  
pack: 12  
00.30127  
12 cl  
pack: 12



## «Fido»



γυάλινα δοχεία  
glass jars



00.30039  
12,5 cl  
pack: 6



00.30038  
20 cl  
pack: 6  
00.30048  
35 cl  
pack: 6

## Weck γυάλινα με καπάκι



28.00177 112482  
mini tulip, 22 cl  
6 cm | 8 cm  
pack: 12



28.00179 112413  
overtume, 29 cl  
8 cm | 8,7 cm  
pack: 6



28.00176 112437  
overtum, 58 cl  
10 cm | 10,7 cm  
pack: 6



28.00180 112567  
cylinder, 34 cl  
6 cm | 13 cm  
pack: 6



28.00134 112604  
juice, 53 cl  
6 cm | 18,4 cm  
pack: 6



28.00181 112574  
cylinder, 60 cl  
6 cm | 21 cm  
pack: 12



28.00185 112512  
σετ 12 κλιπς  
pack: 12



28.00182 112543  
σετ 10 λάστιχα, 10 cm  
pack: 10



28.00183 112536  
σετ 10 λάστιχα, 8 cm  
pack: 10

28.00184 112529  
σετ 10 λάστιχα, 6 cm  
pack: 10

## «lock eat»

Lugli Bormioli



γυάλινο δοχείο  
glass jar

08.00913  
20 cl  
8,5 cm | 9,7 cm  
pack: 12



μπουκάλια | bottles

08.00912  
25 cl  
7,1 cm | 16,7 cm  
pack: 12



08.00910  
50 cl  
7,3 cm | 21,1 cm  
pack: 6

## Weck με ξύλινο καπάκι



\*27.82243  
βάζο, 37 cl  
weck-glasses with lid  
11 cm | 7,5 cm  
pack: 2



\*27.82244  
βάζο, 58 cl  
weck-glasses with lid  
11 cm | 11 cm  
pack: 2



\*27.82362  
ξύλινο καπάκι  
wooden lid,  
11 cm | 2 cm  
pack: 1





*Lugè Bornioli*

## Thermic glass

	<b>08.00318</b> σετ 2 μπολ κωνικά 12 cl 7,3 cm   6,5 cm pack: 2/12
	<b>08.00120</b> σετ 2 μπολ κυλινδρικά 11 cl 6,2 cm   6,9 cm pack: 2/12

*Lugè Bornioli*

## food & design

	<b>*08.00544</b> RM461 σετ 2 χύτρες, 27 cl 10,4 cm   5,4 cm pack: 4
	<b>*08.00540</b> RM464 σετ 2 χύτρες με καπάκι, 25 cl 9,5 cm   9,3 cm pack: 4
	<b>*08.00542</b> RM462 σετ 2 κασαρολάκια, 16 cl - 9,2 cm   4,5 cm pack: 6

 Bergonovo

	<b>01.44023</b> «Indro» 21 cl 7,2 cm   8,2 cm pack: 12
	<b>01.10837</b> «Oval» 9 cl 6,5 cm   6,5 cm pack: 6
	<b>01.10816</b> «Indro» baby 4,2 cl 4,2 cm   7 cm pack: 24
	<b>01.13098</b> «Palladio quadro», 6 cl 5x5 cm   6 cm pack: 48

*Lugè Bornioli*

## Michelangelo

	<b>08.00521</b> PM969 κύβος, 14 cl 5,6 cm   6 cm pack: 6/24
	<b>08.00522</b> PM970 κύλινδρος, 15 cl 6,2 cm   6 cm pack: 6/24
	<b>08.00523</b> PM968 τρίγωνο, 15 cl 6 cm   6 cm pack: 6/24
	<b>08.00520</b> PM966 οβάλ, 15 cl 5,2x7,2 cm   6 cm pack: 6/24



## «OAK»



- \*27.84720 GN 1/1  
53x32,5 cm | 1 cm  
pack: 1
- \*27.84721 GN 1/2  
32,5x26,5 cm | 1 cm  
pack: 1
- \*27.84722 GN 1/3  
32,5x17,6 cm | 1 cm  
pack: 1
- \*27.84723 GN 1/4  
26,5x16,2 cm | 1 cm  
pack: 1
- \*27.84724 GN 2/4  
53x16,2 cm | 1 cm  
pack: 1



APS

## «Slate» GN



- 27.83955 GN 1/1 (53x32,5 cm)  
pack: 1
- 27.83956 GN 1/2 (32,5x26,5 cm)  
pack: 1
- 27.83957 GN 1/3 (32,5x17,5 cm)  
pack: 1
- 27.83958 GN 1/4 (26,5x16,2 cm)  
pack: 1
- 27.83971 GN 2/4 (53x16,2 cm)  
pack: 1



- \*27.83981 δίσκος με γείσο  
tray with rim, GN 1/1  
53x32,5 cm | 1,5 cm  
pack: 1



- \*27.83980 δίσκος με χέρια χρωμίου  
tray chrome plated handles  
53x32,5 cm | 6 cm  
pack: 1

APS

## «Slate-Rock»



- στρογγυλός με χέρι | round with handle  
\*27.84257 30 cm | 1,5 cm  
pack: 1



- ορθογώνιοι με χέρι  
rectangular with handle  
\*27.84258 40x20 cm | 1,5 cm  
pack: 1
- \*27.84259 48x20 cm | 1,5 cm  
pack: 1

APS



APS



- \*27.84262 στρογγυλός | round  
35 cm | 3 cm  
pack: 1
- \*27.84205 GN 1/1  
53x32,5 cm | 1,5 cm  
pack: 1
- \*27.84206 GN 1/2  
32,5x26,5 cm | 1,5 cm  
pack: 1
- \*27.84207 GN 1/3  
32,5x17,6 cm | 1,5 cm  
pack: 1
- \*27.84208 GN 1/4  
26,5x16,2 cm | 1,5 cm  
pack: 1
- \*27.84209 GN 2/4  
53x16,2 cm | 1,5 cm  
pack: 1



APS

Δίσκοι «Zero» trays



Δίσκοι GN λευκοί, πάχους 1,5 cm  
GN white trays, 1,5 cm thickness

- 27.84185 GN 1/1  
pack: 1
- 27.84186 GN 1/2  
pack: 1
- 27.84187 GN 1/3  
pack: 1
- \*27.84188 GN 1/4  
pack: 1
- 27.84189 GN 2/4  
pack: 1

Δίσκοι GN μαύροι, πάχους 1,5 cm  
GN black trays, 1,5 cm thickness

- \*27.84195 GN 1/1  
pack: 1
- \*27.84196 GN 1/2  
pack: 1
- \*27.84197 GN 1/3  
pack: 1
- \*27.84198 GN 1/4  
pack: 1
- \*27.84199 GN 2/4  
pack: 1



CAMBRO

«ShowFest»

Δίσκοι για τον μπουφέ, την βιτρίνα ή το salad bar. Από ανθεκτικό SAN σε πολλά σχήματα για μια όμορφη παρουσίαση.

Showcase cold deli, buffet and salad bar items.  
Made from SAN for impact, stain, break & chip resistance.

μπολ οκτάγωνα   octagonal display bowls	
	92.10000 2,8 lt SFG1012 25,4x30,5 cm   5 cm pack: 6
	92.10001 3,3 lt SFG1015 25,4x38 cm   5 cm pack: 6
	92.10003 3,7 lt SFG820 20,3x50,8 cm   5 cm pack: 6
	92.10002 5,8 lt SFG1220 30,5x50,8 cm   5 cm pack: 6
	92.10004 μπολ ορθογώνιο, 4,3 lt SFR1012 rectangular display bowl 25,4x31,8 cm   7,6 cm pack: 6
	92.10005 μπολ τρίγωνο, 1,9 lt SFT1010 triangle display bowl 25,4x30,5 cm   6,4 cm pack: 6
	92.10006 μπολ τρίγωνο, 2,8 lt SFT1212 triangle display bowl 30,5x38 cm   6,4 cm pack: 6
	92.10007 μπολ τρίγωνο, 4,2 lt SFT1515 triangle display bowl 38x50,8 cm   6,4 cm pack: 6
	92.10008 μπολ οβάλ, 2,8 lt SFV1015 oval display bowl 25,4x38 cm   5 cm pack: 6



γυάλινες πιατέλες | *glass platters*



Βαργονοβί

01.65036  
«Palladio»  
πιατέλα  
με γυάλινο καπάκι  
*glass platter with dome lid*  
31 cm | 15,5 cm  
pack: 1/4



Βαργονοβί

01.65034  
πιατέλα με πόδι  
και γυάλινο καπάκι  
*footed glass platter  
with dome lid*  
31 cm  
pack: 1/4



Βαργονοβί

00.65050  
«Ginerva» πιατέλα  
με πλαστικό καπάκι  
*glass platter with  
plastic dome lid*  
29 cm | 15 cm  
pack: 3



Βαργονοβί

01.65038  
«Palladio»  
πιατέλα  
με γυάλινο καπάκι  
*glass platter with dome lid*  
22 cm  
pack: 1/4



Βαργονοβί

01.65039  
«Palladio»  
πιατέλα με πόδι  
και γυάλινο καπάκι  
*footed glass platter  
with dome lid*  
22 cm  
pack: 1/3



Βαργονοβί

01.56063  
«Palladio»  
πιατέλα με πόδι  
*footed glass platter*  
32 cm  
pack: 1



Βαργονοβί

01.56062  
«Upr»  
πιατέλα με πόδι  
*footed glass platter*  
32 cm  
pack: 1

πιατέλες με πόδι | *platters*



APS

\*27.00444 πιατέλα με πόδι  
περιστρεφόμενη, inox  
*rotating cake stand*  
30 cm | 7 cm  
pack: 1



APS

\*27.00463 πιατέλα με πόδι  
περιστρεφόμενη, inox  
*rotating cake stand*  
30,5 cm | 9 cm  
pack: 1



APS

27.00652 πιατέλα inox στρογγυλή  
με 2 καπάκια 7&11 cm  
*cake plate inox with 2 covers*  
30 cm | 7+11 cm  
pack: 1

καπάκια καμπίνα | *domes*



«Super Dome»  
καπάκι καμπίνα PC,  
με καθαρότητα κρυστάλλου  
*cover PC, stable, crystal clear quality*

\*27.06525 30 cm | 40 cm  
pack: 1



27.06519 καπάκι καμπίνα PC  
*PC cover*  
21 cm | 17 cm  
pack: 1





27.06520 καπάκι καμπίνα PC  
*PC cover*  
30 cm | 22 cm  
pack: 1



27.06521 καπάκι καμπίνα PC  
*PC cover*  
36 cm | 27 cm  
pack: 1



πιατέλες μελαμίνης | *melamine cake plates*

	<p>πιατέλες στρογγυλές μαύρες <i>black round cake plates</i></p> <p>*27.85046 21,5 cm   2,5 cm pack: 1</p>
	<p>*27.85047 30,5 cm   3,5 cm pack: 1</p>
	<p>*27.85048 37,5 cm   4 cm pack: 1</p>
	<p>δίσκος παρουσίασης   <i>cake stand</i> 31 cm   4 cm</p>
	<p>*27.00468 λευκός   <i>white</i> pack: 1</p>
	<p>*27.00469 μαύρος   <i>black</i> pack: 1</p>
	<p>δίσκοι «Loops»   <i>trays</i></p>
	<p>*27.85033 21,5 cm   2,5 cm pack: 1</p>
	<p>*27.85034 30,5 cm   3,5 cm pack: 1</p>
	<p>*27.85035 37,5 cm   4 cm pack: 1</p>

GARIBALDI



stand μαύρο plexiglass  
*black plexiglass stand*

96.50127 30 cm | 10 cm  
pack: 1

96.50128 30 cm | 16 cm  
pack: 1

96.50129 30 cm | 22 cm  
pack: 1



96.50126 καπάκι καμπάνα PC  
*PC cover*  
28 cm  
pack: 1

γυάλινα σουπλά | *chargers*

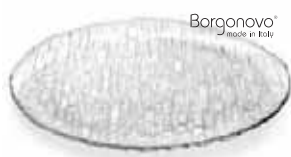

Borgonovo®  
MADE IN ITALY









01.11273 σουπλά | *charger*  
«Oak»  
32 cm  
pack: 8



ΝΕΟ  
Design

00.56162 σουπλά | *charger*  
«Inca»  
31 cm  
pack: 12

πιατέλες μελαμίνης με πόδι | *melamine cake plates*

	<p>πιατέλες τετράγωνα λευκές «Casual» <i>white square cake plates</i></p>
	<p>27.83892 31x31 cm   8 cm pack: 1</p>
	<p>27.83893 31x31 cm   16 cm pack: 1</p>
	<p>πιατέλες στρογγυλές λευκές «Casual» <i>white round cake plates</i></p>
	<p>27.83890 31 cm   8 cm pack: 1</p>
	<p>27.83891 31 cm   16 cm pack: 1</p>
	<p>πιατέλες στρογγυλές λευκές <i>white round cake plates</i></p>
	<p>*27.85051 30,5 cm   9 cm pack: 1</p>
	<p>*27.85052 30,5 cm   17 cm pack: 1</p>

micro καμπάνες | *micro cloches*



RONA  
2serve



28.70019 καμπάνα micro  
*micro cloche*  
14 cm | 19 cm  
pack: 1

28.70002 καμπάνα micro  
*micro cloche*  
11 cm | 10,4 cm  
pack: 6/24

28.70003 καμπάνα micro  
*micro cloche*  
8,3 cm | 15 cm  
pack: 6/24

28.70004 καμπάνα micro  
*micro cloche*  
9,1 cm | 16 cm  
pack: 6/24

## στάντ «κύβος» GN stands

APS

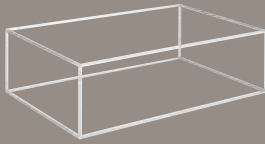

στάντ GN 1/1  
53x32,5x16,2 cm (για GN 1/1 + 2/4)  
\*27.15501 χρωμίου | *chrome*  
pack: 1  
\*27.15504 μαύρο | *black*  
pack: 1

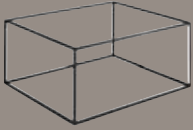

στάντ GN 1/2  
32,5x26,5x16,2 cm (για GN 1/2 + 1/4)  
\*27.15502 χρωμίου | *chrome*  
pack: 1  
\*27.15505 μαύρο | *black*  
pack: 1

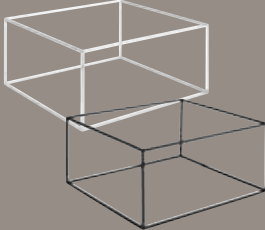

στάντ GN 1/3  
35,4x32,5x17,6 cm (για GN 1/3 + 2/3)  
\*27.15503 χρωμίου | *chrome*  
pack: 1  
\*27.15506 μαύρο | *black*  
pack: 1

APS



## King» stands

APS



μεταλλικά στάντ δίσκων χρωμίου  
αντιολισθητικά μπράτσα  
*chrome buffet stand  
with black anti-slide coating*

\*27.03622 «King M»  
15 cm | 14 cm  
pack: 1

\*27.03623 «King L»  
15 cm | 21 cm  
pack: 1



## στάντ / βάσεις για δίσκους «Multi» stands

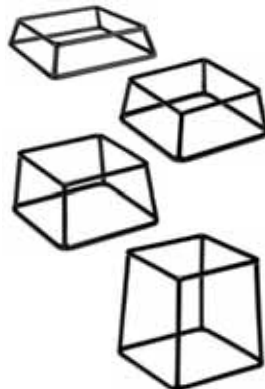

μεταλλικά στάντ δίσκων,  
αντιολισθητικά  
*metal buffet stand  
with black anti-slide coating*

27.33249 18x18 cm | 5 cm  
pack: 1

27.33250 18x18 cm | 8 cm  
pack: 1

27.33251 18x18 cm | 10 cm  
pack: 1

27.33252 18x18 cm | 18 cm  
pack: 1



## στάντ / βάσεις για δίσκους | stands

APS

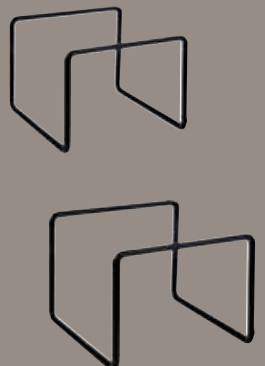

μεταλλικό στάντ, μαύρο  
με αντιολισθητική επίστρωση  
(χρησιμοποιείται κάθετα ή οριζόντια)  
*buffet stand made of metal  
with non-slip coating  
(vertically or horizontally,  
there are variable usage possibilities)*

\*27.33278 11,5x11,5 cm | 9 cm  
pack: 1

\*27.33279 16,5x16,5 cm | 14,5 cm  
pack: 1



APS

stands «Star»



μεταλλικά σταντ δίσκων,  
αντιολισθητικά  
metal buffet stand  
with black anti-slide coating

- 27.33260 ύψος | height: 8 cm  
pack: 1
- 27.33261 ύψος | height: 12 cm  
pack: 1
- 27.33262 ύψος | height: 18 cm  
pack: 1

APS

service stands

APS

stands «Wood»



- service stands  
3 θέσεων | 3-tier
- \*27.33215 χρωμίου  
chrome stand  
18,5x15 cm | 16 cm  
pack: 1
  - \*27.33211 copper  
copper stand  
18,5x15 cm | 16 cm  
pack: 1
- service stands  
3 θέσεων | 3-tier
- 27.33220 χρωμίου | chrome stand  
29x19,5 cm | 43 cm  
pack: 1
  - \*27.33212 copper | copper stand  
29x19,5 cm | 43 cm  
pack: 1



- σταντ δίσκων από ξύλο ακακίας  
για πλάγια ή όρθια χρήση  
acacia wood stands  
usable by lying or standing,
- \*27.33280 φυσικό χρώμα | natural  
20x20 cm | 17,5 cm  
pack: 1
  - \*27.33281 σκούρο χρώμα | dark  
20x20 cm | 17,5 cm  
pack: 1

«Prisma» stands



- μεταλλικά σταντ δίσκων,  
αντιολισθητικά  
metal buffet stand  
with black anti-slide coating
- \*27.33272 20 cm | 10,5 cm  
pack: 1
  - \*27.33273 20 cm | 20 cm  
pack: 1

service stand

GenWare



- 34.60469 service σταντ μεταλλικό  
2 επιπέδων  
συνδυάζεται με  
πίατα 20,5 cm  
two-tier display presentation  
plate stand, combined with  
20.5 cm dishes.  
20,5x21,5 cm | 30,5 cm  
pack: 1



γυάλινα μπολ οπαλίνας | *durable white glass bowls*



00.56142 0,53 lt  
14,7 cm | 6,5 cm  
pack: 1

00.56141 1,2 lt  
18,6 cm | 9 cm  
pack: 1

γυάλινα μπολ «Pompei» glass bowls



00.44350 3,9 cl  
6 cm | 3 cm  
pack: 24



00.44351 10 cl  
8 cm | 4,1 cm  
pack: 24



00.44352 24 cl  
10,5 cm | 5,3 cm  
pack: 24



00.44353 35 cl  
12 cm | 6 cm  
pack: 24



00.44354 57 cl  
14 cm | 7 cm  
pack: 24



00.44355 1 lt  
17 cm | 8,5 cm  
pack: 6

00.44356 1,7 lt  
20 cm | 10 cm  
pack: 6

00.44357 2,45 lt  
23 cm | 10,2 cm  
pack: 4

00.44358 3,65 lt  
26 cm | 11,5 cm  
pack: 4



Borgonovo®  
made in Italy

γυάλινα μπολ «Modi» glass bowls



01.44056 17 cl  
8x8 cm  
pack: 36



01.44017 27 cl  
10,5x10,5 cm  
pack: 36



01.44053 80 cl  
14x14 cm  
pack: 12







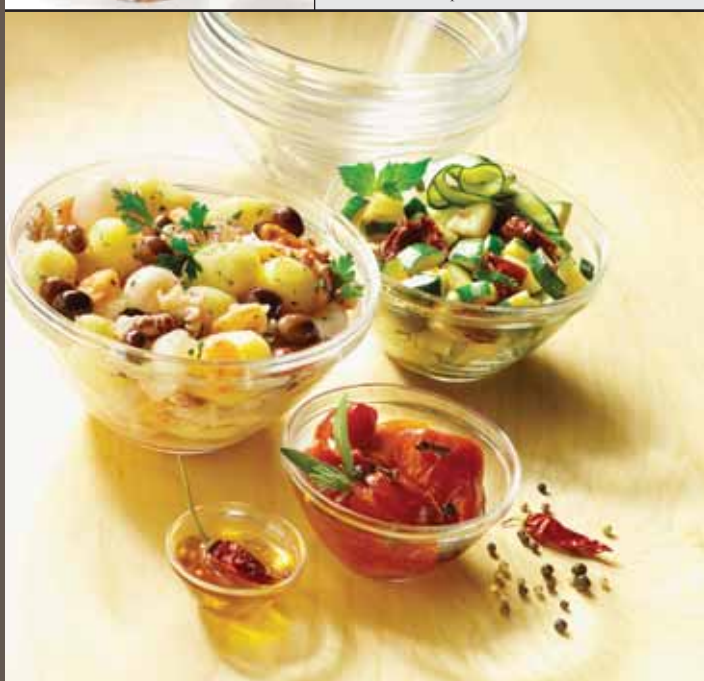

01.44054 1,2 lt  
20x20 cm  
pack: 6

01.44055 1,85 lt  
25x25 cm  
pack: 4









γυάλινα μπολ «*Mr Chef*» glass bowls

	00.44180 8,5 cl 8,8 cm   3,6 cm pack: 36
	00.44181 18 cl 11,2 cm   4,8 cm pack: 24
	00.44182 37 cl 14 cm   6,1 cm pack: 24
	00.44183 75 cl 17,5 cm   7,5 cm pack: 12
	00.44184 1,6 lt 22,2 cm   9,7 cm pack: 6
	00.44185 2,6 lt 26,2 cm   11,1 cm pack: 6
	00.44186 3,9 lt 30,2 cm   12,6 cm pack: 6









Borgonovo<sup>®</sup>  
made in Italy

γυάλινα μπολ «*Magic*» glass bowls

	01.44150 11 cm pack: 6/36
	01.44151 14 cm pack: 6/24
	01.44153 19 cm pack: 6
	01.44152 24 cm pack: 6



Borgonovo<sup>®</sup>  
made in Italy

γυάλινα μπολ «*Practica*» glass bowls

	01.44102 10 cm (15 cl) pack: 6/36
	01.44103 12 cm (25 cl) pack: 6/36
	01.44104 14 cm (38 cl) pack: 6/24
	01.44105 18 cm (87 cl) pack: 6
	01.44106 23 cm (165 cl) pack: 4
	01.44107 25 cm, (250 cl) pack: 4



γυάλινα μπολ «*Viva*» glass bowls

	00.44162 1,5 lt 20 cm   9,3 cm pack: 12
	00.44163 2,3 lt 23 cm   10,6 cm pack: 6
	00.44165 5,25 lt 29 cm   13,5 cm pack: 6



























γυάλινα δοχεία τροφίμων | storage glass jars



δοχεία «Fido» preserving jars

	00.30039	12,5 cl	pack: 6
	00.30038	20 cl	pack: 6
	00.30048	35 cl	pack: 6
	00.30030	50 cl	pack: 6
	00.30031	75 cl	pack: 6
	00.30032	100 cl	pack: 6
	00.30033	150 cl	pack: 6
	00.30034	200 cl	pack: 6
	00.30035	300 cl	pack: 6
	00.30036	400 cl	pack: 6
	00.30037	500 cl	pack: 6

δοχεία «Quattro Stagioni» preserving jars

	00.30100	15 cl	pack: 12
	00.30101	25 cl	pack: 12
	00.30102	50 cl	pack: 12
	00.30128	70 cl	pack: 12
	00.30103	100 cl	pack: 12
	00.30104	150 cl	pack: 6
	00.30105	30 cl	pack: 12
	00.30106	50 cl	pack: 12
	00.70127	μπουκάλι   bottle, 1 lt	pack: 12
	00.30126	4 cl	pack: 12
	00.30127	12 cl	pack: 12

anchor



90.69857 δοχείο με καπάκι  
2,2 lt  
pack: 1

90.69590 δοχείο με καπάκι  
3,8 lt  
pack: 1

Bormioli



00.31041 δοχείο «Pandora»,  
με πλαστικό καπάκι  
2,2 lt  
pack: 6

anchor



90.85812 δοχείο με καπάκι, 1 lt  
pack: 1

90.85787 δοχείο με καπάκι, 2,2 lt  
pack: 1

90.85725 δοχείο με καπάκι, 3,78 lt  
pack: 1

anchor



90.88750 δοχείο με καπάκι  
«Cookie», 3,8 lt  
pack: 1

anchor



90.69349 δοχείο με καπάκι  
3,8 lt  
pack: 1

90.69372 δοχείο με καπάκι  
7,6 lt  
pack: 1

anchor



90.95541 δοχείο με ασημί καπάκι  
«Montana», 2,9 lt  
pack: 1

90.95506 δοχείο με ασημί καπάκι  
«Montana», 5,6 lt  
pack: 1

90.91523 δοχείο με ασημί καπάκι  
«Montana», 7,57 lt  
pack: 1

90.95507 δοχείο με ασημί καπάκι  
«Montana», 9,46 lt  
pack: 1

σκεύη πορσελάνης «Organic» porcelain items

	<p>VISTA ALEGRE 1824</p> <p>38.85929 πιατέλα τετράγωνη <i>rectangular platter</i> 32x32 cm pack: 4</p>
	<p>38.94085 πιατέλα τρίγωνη <i>triangular platter</i> 40,5x40,5 cm pack: 1</p>
	<p>38.94083 πιατέλα οβάλ <i>oval platter</i> 36,5x23 cm pack: 1</p>
	<p>38.87656 πιατέλα οβάλ <i>oval platter</i> 48x29 cm pack: 1</p>



σκεύη πορσελάνης | porcelain serving items

<p>bon<b>bistro</b></p>  <p>σαλατιέρες με λαβή. εύχρηστες, βολικές, δίνουν λύσεις με χάρη. Εύκολες στην αποθήκευση αφού μπαίνει η μία μέσα στην άλλη. <i>Salad bowls with handle. Convenient, give solutions with grace. Space savers once they enter one another.</i></p>	
	<p>30.71086 11x10 cm   3 cm pack: 1</p>
	<p>30.71087 14x11,5 cm   4,5 cm pack: 1</p> <p>30.71088 18x16 cm   6,5 cm pack: 1</p> <p>30.71089 23x20,5 cm   8 cm pack: 1</p>









δοχεία GN πορσελάνης | GN porcelain pans

	<p>8 SCHÖNWALD</p> <p>δοχεία GN πορσελάνης <i>porcelain GN pans</i></p> <p>*30.60214 GN 1/1 53x32,5 cm   2 cm pack: 1</p>
	<p>30.60215 GN 1/1 53x32,5 cm   6,5 cm pack: 1</p> <p>*30.60217 GN 1/2 32,5x26,5 cm   6,5 cm pack: 1</p>

δοχεία GN πορσελάνης | GN porcelain pans







	<p>HENDI</p> <p>δοχεία GN πορσελάνης <i>porcelain GN pans</i></p> <p>30.41066 GN 1/1 53x32,5 cm   6,5 cm pack: 1</p>
	<p>30.41067 GN 1/2 32,5x26,5 cm   6,5 cm pack: 1</p>
	<p>30.41068 GN 1/3 32,5x17,6 cm   6,5 cm pack: 1</p>

σκεύη πορσελάνης | porcelain serving items





	<p>VISTA ALEGRE 1824</p> <p>δίσκοι μπουφέ   <i>buffet trays</i></p> <p>38.03254 39,7x30,5 cm   2,8 cm pack: 1</p>
	<p>38.03257 50,8x15,2 cm   2,8 cm pack: 1</p>
	<p>δίσκοι μπουφέ βαθιοί   <i>deep buffet trays</i></p> <p>38.03256 51x12,4 cm   5,1 cm pack: 1</p>
	<p>38.03255 35,5x8,8 cm   3,6 cm pack: 1</p>
	<p>μπολ σαλάτας   <i>salad bowls</i></p> <p>38.03252 24,4x24,4 cm   8,8 cm pack: 1</p>
	<p>μπολ μπουφέ   <i>buffet bowls</i></p> <p>38.03258 22,2x14,8 cm   7,6 cm pack: 3</p>
	<p>38.03259 28,9x18,6 cm   9,3 cm pack: 1</p>
	<p>μπολ μπουφέ   <i>buffet bowls</i></p> <p>38.03261 13,2x9,7 cm   4,8 cm pack: 4</p>
	<p>38.03263 19,4x14,1 cm   6,9 cm pack: 6</p>



σκεύη πορσελάνης «Sea food» porcelain items







	<p>πιατέλα με ανάγλυφο σχέδιο <i>embossed platter</i></p> <p>52.84815 50x20,5 cm pack: 1</p>
	<p>πιατέλες ψαριού   <i>fish dishes</i></p> <p>52.84810 24x15 cm pack: 6</p> <p>52.84811 30x19 cm pack: 6</p> <p>52.84812 39x26 cm pack: 6</p>
	<p>52.52864 πιατέλα «κοχύλι» <i>«shell» dish</i> 41 cm pack: 6</p>
	<p>52.52863 πιατέλα «κοχύλι» <i>«shell» dish</i> 41 cm pack: 6</p>
	<p>52.84813 πιατέλα «κοχύλι» <i>«shell» dish, 24 cm</i> pack: 12</p> <p>52.84814 πιατέλα «κοχύλι» <i>«shell» dish, 34 cm</i> pack: 6</p>
	<p>52.52861 μπουλ «κοχύλι», 27 cm pack: 1</p> <p>52.52862 μπουλ «κοχύλι», 36 cm pack: 1</p>
	<p>52.52125 πιάτο οστράκων <i>shell plate</i> 28 cm pack: 6</p>

σκεύη πορσελάνης «Jumeirah» porcelain items

	<p>52.56505 μπουλ   <i>bowl</i> 26 cm pack: 4</p>
	<p>52.56507 πιατέλα οβάλ   <i>oval platter</i> 39x16 cm pack: 6</p>
	<p>52.56508 πιατέλα οβάλ   <i>oval platter</i> 49x19 cm pack: 1</p>
	<p>52.56506 μπουλ οβάλ   <i>oval bowl</i> 30x20 cm pack: 2</p>
	<p>52.56509 πιατέλα στρογγυλή <i>round platter</i> 42 cm pack: 1</p>

σκεύη πορσελάνης | porcelain serving items

GÜRAL  
PORSELEN

	<p>52.56504 «Santorini» πιατέλα   <i>platter</i> 38 cm pack: 6</p>
	<p>52.56502 πιατέλα βαθιά, οβάλ <i>oval deep platter</i> 48x35 cm pack: 1</p>
	<p>52.56503 πιατέλα βαθιά ορθογώνια <i>rectangular deep platter</i> 40x30 cm pack: 1</p>
	<p>πιάτο pizza   <i>pizza plate</i></p> <p>52.52127 30 cm pack: 6</p> <p>52.56213 33 cm pack: 6</p>
	<p>μπουλ στρογγυλό, βαθύ <i>deep round bowl</i></p> <p>52.52821 30 cm pack: 1</p> <p>52.52822 35 cm pack: 1</p>
	<p>μπουλ στρογγυλό, βαθύ <i>deep round bowl</i></p> <p>52.52823 35 cm pack: 1</p>
	<p>μπουλ οβάλ «Dublin»   <i>oval bowl</i></p> <p>52.52841 26 cm pack: 1</p> <p>52.52842 36 cm pack: 1</p>



	39.01127 φόρμα τάρτας «Fusion» 30 cm   5,5 cm pack: 4		39.01275 ταψί παραλ/μο «Vector» 31x22x6,5 cm pack: 4
	39.01129 φόρμα «Fusion» 20 cm   3,8 cm pack: 4		39.01274 ταψί παραλ/μο «Vector» 36x27x7 cm pack: 4
	39.01128 σετ 2 ραμκέν «Fusion» 11 cm   5,2 cm pack: 6		39.01279 σετ 4 ραμκέν «Vector» 6 cm   4 cm pack: 12
	39.01130 φόρμα σουφλέ «Fusion» 24 cm   9,7 cm pack: 4		39.01278 σετ 2ραμκέν «Vector» 9 cm   5 cm pack: 6
	39.01123 ταψί οβάλ «Fusion» 28x18x6 cm pack: 4		39.01277 ραμκέν «Vector» 12 cm   6 cm pack: 6
	39.01124 ταψί οβάλ «Fusion» 36x25x6 cm pack: 4		39.01142 φόρμα τάρτας «Classic» 12,5 cm   3 cm pack: 4
	39.01126 ταψί παραλ/μο «Fusion» 32x25x6 cm pack: 4		39.01114 φόρμα τάρτας «Classic» 29 cm   4 cm pack: 4
	39.01125 ταψί παραλ/μο «Fusion» 37x29x6 cm pack: 4		39.01144 σουφλέ «Classic» 20 cm   8,5 cm pack: 4
	39.01273 ταψί στρογγυλό «Vector» 25 cm   6 cm pack: 4		39.01143 σαγανάκι «Classic» 24,5x14 cm pack: 4
	39.01272 ταψί στρογγυλό «Vector» 30 cm   6 cm pack: 4		«Classic» ραμκέν   <i>ramekin</i>
	39.01276 ταψί τεράγωνο «Vector» 28x28x6 cm pack: 4		39.00163 9 cm pack: 6
			39.00155 10,5 cm pack: 6





19.55062  
πιρούνι σερβιρίσματος  
*serving fork*  
24 cm  
pack: 1



19.55077  
πιρούνι σερβιρίσματος  
*serving fork*  
30 cm  
pack: 1



19.55063  
πιρούνι σερβιρίσματος  
*serving fork*  
30 cm  
pack: 1



19.55060  
κουτάλι σερβιρίσματος  
*serving spoon*  
24 cm  
pack: 1



19.55055  
κουτάλι σερβιρίσματος  
*serving spoon*  
24 cm  
pack: 1



19.55056  
κουτάλι σερβιρίσματος  
τρυπητό  
*slotted serving spoon*  
24 cm  
pack: 1



19.55059  
κουτάλι σερβιρίσματος  
τρυπητό  
*slotted serving spoon*  
30 cm  
pack: 1



19.55057  
κουτάλι σερβιρίσματος  
*serving spoon*  
30 cm  
pack: 1



19.55054  
κουτάλι σερβιρ. ριζότο  
*risotto serving spoon*  
26 cm  
pack: 1



19.55058  
κουτάλι σερβιρ. ριζού  
*rice serving spoon*  
26 cm  
pack: 1



19.55080  
κουτάλα τρυπητή  
*ice spoon*  
24 cm  
pack: 1



19.55081  
κουτάλα σάλτσας  
*sauce ladle*  
35 cm  
pack: 1



19.55061  
σπάτουλα σερβιρίσματος  
*cake server*  
28 cm  
pack: 1



19.55082  
σπάτουλα τρυπητή  
*spatula*  
30 cm  
pack: 1



19.55076  
σπάτουλα σερβιρίσματος  
*cake server*  
30 cm  
pack: 1



19.55083  
πιρούνα ψητού  
*curved carving fork*  
33 cm  
pack: 1



για άλλα εργαλεία  
σερβιρίσματος  
ανατρέξτε  
στον κατάλογο  
«HENDI 2023»





19.24141  
πιρούνι σερβιρίσματος  
*silver fork*, 25,5 cm  
pack: 1



19.24142  
κουτάλι σερβιρίσματος  
*silver spoon*, 25,5 cm  
pack: 1



19.24144  
κουτάλι σάλτσας  
*sauce ladle*, 17,4 cm  
pack: 1



19.24145  
σπάτουλα  
*cake server*, 23 cm  
pack: 1



19.24143  
κουτάλα βαθιά  
*silver ladle*, 26,5 cm  
pack: 1



κουτάλες st. steel με λαβή PP | *utensils with PP handle*



HENDI

30.40153 κουτάλα  
*silver spoon*  
35 cm  
pack: 1



30.40154 κουτάλα τρυπητή  
*skimmer*  
34,5 cm  
pack: 1



30.40155 πιρούνα  
*carving fork*  
34,5 cm  
pack: 1



30.40156 σπάτουλα τρυπητή  
*slotted spatula*  
35,5 cm  
pack: 1

κουτάλες σερβιρίσματος | *silver spoons*



HENDI

κουτάλες σερβιρίσματος SAN  
*SAN silver spoons*

30.40204 μαύρη | *black*, 33,5 cm  
pack: 1

30.40662 λευκή | *white*, 33,5 cm  
pack: 1

κουτάλες σαλάτας SAN | *salad spoons*



30.40659 λευκή | *white*  
23,5 cm (3 cl)  
pack: 1

30.40660 μαύρη | *black*  
23,5 cm (3 cl)  
pack: 1

30.40661 διάφανη | *clear*  
23,5 cm (3 cl)  
pack: 1

CAMBRO

άθραυστα εργαλεία σερβιρίσματος  
*Made of virtually unbreakable Camwear,  
spoons won't tarnish, bend or dent.*



92.00856 κουτάλα σερβιρίσματος  
*silver spoon*  
28 cm  
pack: 1



92.00855 τρυπητή κουτάλα  
σερβιρίσματος  
*perforated silver spoon*  
25 cm  
pack: 1



92.00854 λαβίδα σερβιρίσματος  
*silver tong*  
25 cm  
pack: 1

APS κουτάλες inox αντιολισθητικές | *non-slip items*



\*27.00832 κουτάλα βαθιά  
*ladle*  
35 cm  
pack: 1



\*27.00833 κουτάλα σερβιρ. τρυπητή,  
*slotted silver spoon*,  
37,5 cm  
pack: 1



\*27.00834 κουτάλα σερβιρίσματος  
*silver spoon*  
37,5 cm  
pack: 1

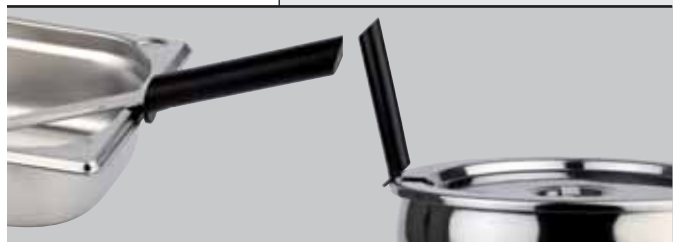



λαβίδες σερβιρίσματος | *serving tongs inox 18/10*

	19.55071 λαβίδα chef   <i>chef tong</i> 35 cm pack: 1/12
	19.55067 λαβίδα ψητού <i>roast meat tong</i> 26 cm pack: 1/12
	19.55074 λαβίδα ψητού <i>roast meat tong</i> 21 cm pack: 1/12
	19.55068 λαβίδα ψωμιού <i>bread tong</i> 26 cm pack: 1/12
	19.55075 λαβίδα ψωμιού <i>bread tong</i> 22 cm pack: 1/12
	19.55069 λαβίδα σαλάτας <i>salad tong</i> 26 cm pack: 1/12
	19.55070 λαβίδα σαλάτας <i>salad tong</i> 26 cm pack: 1/12
	19.55073 λαβίδα σαλάτας <i>salad tong</i> 24 cm pack: 1/12
	19.55079 λαβίδα γενικής χρήσης <i>serving tong</i> 24 cm pack: 1/12
	19.55072 λαβίδα σπαγγέτι <i>spaghetti tong</i> 24 cm pack: 1/12
	19.55078 λαβίδα σπαγγέτι <i>spaghetti tong</i> 26 cm pack: 1/12

PINTEX



λαβίδες σερβιρίσματος | *serving tongs*

	27.00685 λαβίδα σαλάτας <i>salad serving tong 18/8</i> 25 cm pack: 1
	27.00688 λαβίδα σερβιρίσματος <i>multipurpose tong 18/8</i> 25 cm pack: 1
	27.00687 λαβίδα σερβιρίσματος <i>bread and pastry tong 18/8</i> 25 cm pack: 1

για άλλα εργαλεία σερβιρίσματος  
ανατρέξτε στον κατάλογο  
«HENDI 2023»







εργαλεία θαλασσινών | *seafood tools*

	10.40301	πένοσα αστακού <i>lobster cracker</i> 15 cm pack: 12/144
	30.80036	πένοσα αστακού <i>lobster pincer</i> 18,5 cm pack: 1
	27.74201	πένοσα αστακού αλουμινίου <i>lobster cracker, aluminium</i> 14x5,5 cm pack: 1
	30.42196	πένοσα αστακού και ξηρών καρπών, μαύρη ματ <i>nut and seafood cracker, matt black</i> 16x3,5 cm pack: 1
	30.42197	πένοσα αστακών και καβουριών, κόκκινη, <i>lobster and crab cracker, red</i> 14x6,2 cm pack: 1
	25.40058	σετ 12 πιρούνια θαλασσινών, <i>set 12 seafood forks</i> 18 cm pack: 1

*cake serve*





	*27.75912	μαχαίρι κέικ <i>cake knife</i> , 26,5 cm pack: 1
--	-----------	--

*spoon rests*

	30.40986	spoon rest, inox 27x11,5 cm pack: 1
	27.83897	spoon rest μελαμίνης   <i>melamine</i> 26x13 cm pack: 1
	*27.83801	spoon rest μελαμίνης   <i>melamine</i> 26x10,5 cm   5 cm pack: 1
	*27.83803	spoon rest μελαμίνης   <i>melamine</i> 22,5x11 cm   6 cm pack: 1

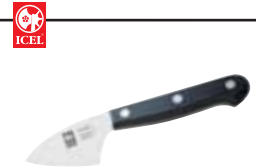

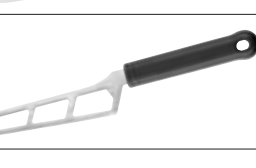
μαχαίρια τυριού | *cheese knives*

	47.34170	μαχαίρι παρμεζάνας <i>parmesan knife</i> 6 cm pack: 1
	47.34171	μαχαίρι τυριού <i>semi hard cheese knife</i> 12 cm pack: 1
	47.34172	μαχαίρι τυριού <i>soft cheese knife</i> 12 cm pack: 1
	47.34173	μαχαίρι μαλακού τυριού <i>cream cheese knife</i> 10 cm pack: 1
	30.41005	μαχαίρι μαλακού τυριού <i>cream cheese knife</i> 16 cm pack: 1
	30.41006	μαχαίρι σκληρού τυριού <i>hard cheese knife</i> 13 cm pack: 1
	35.01999	μαχαίρι τυριού, inox <i>cheese knife</i> pack: 6





## Δίσκοι φυσικής πέτρας | *natural slate trays*



**35.02346** KitchenCraft  
ξύλινο σταντ με 2 δίσκους  
φυσικής πέτρας: (36x14 cm & 36x24 cm)  
*wooden stand with  
2 slates (36x14 cm & 36x24 cm)*  
40x30 cm | 25 cm  
pack: 1



**27.00958**  
ξύλινο σταντ πτυσσόμενο  
με 2 δίσκους φυσικής πέτρας  
*wooden foldable stand  
with 2 slate trays*  
26,5x36,5 cm | 34 cm  
pack: 1

APS



**30.80100**  
δίσκος ακακίας με πέτρινη πλάκα  
*acacia tray with natural stone*  
35x25 cm | 2,5 cm  
pack: 1

Cosy  
& Trendy

Cosy  
& Trendy

**30.80485**  
ξύλινο stand με μια πέτρινη πλάκα  
*wooden stand with natural stone*  
29x19 cm | 14 cm  
pack: 1



**\*27.00810**  
πλατό από ξύλο ακακίας  
με οχιτόλιθο  
*acacia wood tray  
with slate*  
26x18 cm | 2 cm  
pack: 1



APS

**\*27.00867**  
πλατό από ξύλο ακακίας  
με οχιτόλιθο  
*acacia wood tray with slate*  
30,5x13 cm | 1,5 cm  
(+10 cm λαβή/*handle*)  
pack: 1



APS

**\*27.00811**  
πλατό από ξύλο ακακίας με οχιτόλιθο  
*acacia wood tray with slate*  
33x20 cm | 2 cm  
pack: 1



APS

**\*27.00868**  
πλατό από ξύλο ακακίας με οχιτόλιθο  
*acacia wood tray with slate*  
36,5x15 cm | 1,5 cm  
(+12 cm λαβή/*handle*)  
pack: 1



APS

**\*27.00813**  
πλατό από ξύλο ακακίας με οχιτόλιθο  
*acacia wood tray with slate*  
43x12 cm | 2 cm  
pack: 1



APS

**\*27.00869**  
πλατό από ξύλο ακακίας με οχιτόλιθο  
*acacia wood tray with slate*  
42x18 cm | 1,5 cm  
(+14 cm λαβή/*handle*)  
pack: 1



APS

**\*27.00812**  
πλατό από ξύλο ακακίας με οχιτόλιθο  
*acacia wood tray with slate*  
40x15 cm | 2 cm  
pack: 1



APS

## Δίσκοι φυσικής πέτρας | *natural slate trays*

27.00941  
 δίσκος πέτρας  
*slate tray*

24x15 cm  
 συνδυάζεται με τον δίσκο 27.83417  
*combined with tray 27.83417*  
 pack: 1

APS



27.00942  
 δίσκος πέτρας  
*slate tray*

26,5x20,5 cm  
 συνδυάζεται με τον δίσκο 27.83480  
*combined with tray 27.83480*  
 pack: 1

APS



27.00945  
 δίσκος πέτρας  
*slate tray*

47x10 cm  
 συνδυάζεται με τον δίσκο 27.83433  
*combined with tray 27.83433*  
 pack: 1

APS



δίσκοι στρογγυλοί | *round trays*

27.00968 22 cm  
 pack: 1  
 27.00969 28 cm  
 pack: 1  
 27.00998 33 cm  
 pack: 1  
 27.00999 38 cm  
 pack: 1

APS



30.80053  
 mini δίσκος με χέρι  
*mini tray with handle*

14,2x11 cm  
 pack: 1

Cosy  
&Trendy



\*27.00975  
 δίσκος περιστρεφόμενος  
*rotating tray*

32 cm | 2,5 cm  
 pack: 1



27.00994  
 δίσκος πέτρας τετράγωνος  
*square slate tray*

25x25 cm  
 pack: 1

APS



27.00995  
 δίσκος πέτρας τετράγωνος  
*square slate tray*

30x30 cm  
 pack: 1

APS



30.80052  
 δίσκος πέτρας με λαβές  
*slate tray with handles*

50x30 cm  
 pack: 1/10

Cosy  
&Trendy

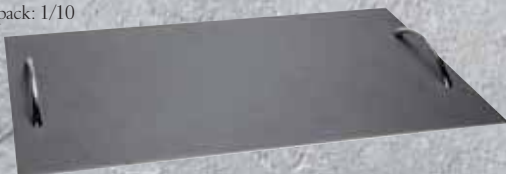

Φυσική πέτρα η οποία έχει υποστεί ειδική επεξεργασία. Κατάλληλη για τρόφιμα (food safe). Υδατοστεγής επιφάνεια (νερό, λάδι, χυμούς, κ.ά.). Δεν μπαίνει στο πλυντήριο πιάτων.  
*Natural stone which has undergone a specific treatment. Suitable for food (food safe). Water-resistant surface (water, oil, juices, etc.). It does not go into the dishwasher.*

δίσκος πέτρας GN | *GN slate tray*

27.00990  
 GN 1/1  
 53x32,5 cm  
 pack: 1

APS



27.00991  
 GN 1/2  
 32,5x26,5 cm  
 pack: 1



27.00992  
 GN 1/3  
 32,5x17,5 cm  
 pack: 1

27.00993  
 GN 1/4  
 26,5x16,2 cm  
 pack: 1



\*27.00973  
 GN 2/4  
 53x16,2 cm  
 pack: 1



27.00996  
 δίσκος πέτρας ορθογώνιος  
*rectangular slate tray*

45x30 cm  
 pack: 1

APS



35.01666  
 δίσκος πέτρας καρδιά  
*slate tray 'heart'*

25 cm  
 pack: 1

KitchenCraft



\*27.00989  
 εταζέρα με 2 δίσκους  
 φυσικής πέτρας  
*2 tier tray with 2 slate trays*

APS



25/20 cm | 24 cm  
 pack: 1

30.71324 764012  
πλατό με λαβή  
serving board with open handle  
50x15 cm  
pack: 1



30.71325 764013  
πλατό με λαβή  
serving board with open handle  
60x22 cm  
pack: 1



30.71332 764002  
δίσκος με λαβή  
serving board with handle  
50x10 cm  
pack: 1



30.71331 764000  
δίσκος με λαβή  
serving board with handle  
50x15 cm  
pack: 1



πλατό με αυλάκι και λαβή  
serving board with groove

30.71327 764010  
54x21 cm  
pack: 1



30.71326 764011  
60x24 cm  
pack: 1

30.71266  
πλατό στρογγυλό | round tray  
45,5x33 cm  
pack: 1



30.71334 709026  
δίσκος πίτσας με λαβή  
pizza serving board with handle  
49/37x30 cm  
pack: 1



30.71323 764021  
δίσκος με χείλος  
serving tray with rim  
36x18 cm | 2 cm  
pack: 1

30.71098  
πλατό με αυλάκι | tray with groove  
45x18,5 cm  
pack: 1



30.71097  
πλατό τετράγωνο  
rectangular tray  
29x22 cm  
pack: 1



30.71333 764035  
πλατό με πόδια  
footed round serving board  
38 cm | 8 cm  
pack: 1



**MW** mango wood

**AW** acacia wood

# Wood Food

— SERVING IS OUR NATURE —

πίατο με λαβή  
serving round board with handle

30.71328 764003

29/20 cm

pack: 1

30.71329 764004

34/25 cm

pack: 1

30.71330 764005

39/30 cm

pack: 1



**AW**



30.71322 764008

μπολ στρογγυλό  
round bowl

22 cm | 6 cm

pack: 1



**AW**

30.71321 764009

μπολ στρογγυλό  
round bowl

26 cm | 6 cm

pack: 1



**AW**

30.71320 764014

μπολ στρογγυλό | round bowl

30 cm | 10 cm

pack: 1



**MW**

30.71319 764015

μπολ στρογγυλό | round bowl

40 cm | 10 cm

pack: 1



**MW**

30.71318 764016

μπολ στρογγυλό | round bowl

50 cm | 10 cm

pack: 1



**MW**

## σκεύη από ξύλο ακακίας | *acacia wood*



GenWare  
δίσκοι από ξύλο ακακίας  
*acacia wood rectangular trays*

34.60013 33x17,5x2 cm  
pack: 1

34.60014 46x17,5x2 cm  
pack: 1



GenWare  
δίσκοι από ξύλο ακακίας  
ορθογώνιοι με αυλάκι  
*acacia wood rectangular trays with groove*

34.60088 34x22 cm | 2 cm  
pack: 1



30.80393 δίσκος σερβιρίσματος  
από ξύλο ακακίας  
*acacia wood serving tray*  
45x30,5 cm | 6 cm  
pack: 1



30.80391 δίσκος από ξύλο ακακίας  
ορθογώνιος με χείλος  
*acacia wood rectangular  
tray with rim*  
29x18 cm | 1,6 cm  
pack: 1



30.80392 δίσκος από ξύλο ακακίας  
ορθογώνιος με χείλος  
*acacia wood rectangular  
tray with rim*  
21,5x15 cm | 1,6 cm  
pack: 1



GenWare  
δίσκος από ξύλο ακακίας  
στρογγυλός  
*acacia wood round tray*  
33 cm  
pack: 1



ξύλινο πλάτο με γείσο «Antique»  
*wood serving tray*  
30.80490 26,5x18,5 cm | 1,2 cm  
pack: 1



πλατό από ξύλο ακακίας, στρογγυλό  
*acacia wood tray, round*

35.02214 41x30 cm  
pack: 1



πλατό από ξύλο ακακίας  
*acacia wood tray*

30.80105 53x16 cm | 1,5 cm  
pack: 1



ξύλινο πλάτο  
*serving - tapas board*

30.80483 60x14 cm | 1,5 cm  
pack: 1



πλατό από ξύλο ακακίας  
*acacia wood tray*

30.80246 38x19 cm | 1,5 cm  
συσκ.: 1



δίσκοι από ξύλο ακακίας  
ορθογώνιοι με χέρι και χείλος  
*acacia wood rectangular tray  
with handle and rim*

30.80389 36x15 cm | 2 cm  
pack: 1



30.80390 39x18 cm | 2 cm  
pack: 1

## βάσεις από ξύλο ακακίας | *acacia wood risers*



βάσεις παρουσίασης  
από ξύλο ακακίας  
*acacia buffet risers*

35.02213 37x12x13 cm  
pack: 1





bonbistro



πλατό από ξύλο μπαμπού με αυλάκι  
*bamboo wood tray with groove*

30.71096 ορθογώνιο | *rectangular*  
40,5x14,5 cm | 1 cm  
pack: 1



Cosy & Trendy

δίσκοι από ξύλο μπαμπού  
ορθογώνιοι με αυλάκι  
*bamboo wood rectangular trays with groove*

30.80102 29x19 cm | 1,8 cm  
pack: 1

30.80039 34x30 cm | 1,8 cm  
pack: 1

30.80101 42x32 cm | 1,8 cm  
pack: 1

30.80103 51x36 cm | 1,8 cm  
pack: 1



δίσκοι από ξύλο μπαμπού  
ορθογώνιοι με αυλάκι  
*bamboo wood rectangular trays with groove*

30.71094 32,5x23 cm | 1,8 cm  
pack: 1



Cosy & Trendy

δίσκος από ξύλο μπαμπού με κείλος  
*bamboo wood tray with rim*

30.80046 29x18 cm | 1,6 cm  
pack: 1/3



Cosy & Trendy

δίσκος από ξύλο μπαμπού με κείλος  
*bamboo wood tray with rim*

30.80047 26x26 cm | 1,6 cm  
pack: 1



bonbistro

δίσκος από ξύλο μπαμπού με κείλος  
*bamboo wood tray with rim*

30.71273 δίσκος bamboo  
40x35 cm | 1,5 cm  
pack: 1

ξύλινα σκεύη | *wooden items*



Cosy & Trendy

30.80040 σετ 4 ξύλινοι δίσκοι  
*set of 4 wooden trays*  
19 cm (14 cm)  
pack: 1

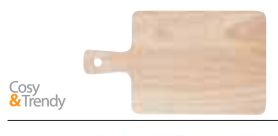

Cosy & Trendy

30.80041 σετ 4 ξύλινοι δίσκοι  
*set of 4 wooden trays*  
19x11 cm  
pack: 1



bonbistro

30.71090 σετ 6 πιατάκια μπαμπού  
*set of 6 bamboo dishes*  
9x9 cm | 1,8 cm  
pack: 1



Cosy & Trendy

steamer bamboo  
30.80244 8 cm | 6 cm  
pack: 1

30.80486 15 cm | 8 cm  
pack: 1

30.80487 18 cm | 8 cm  
pack: 1



Cosy & Trendy

30.80243 σετ 4 ξύλινες παλέτες  
*set of 4 wooden pallets*  
8x12 cm | 2 cm  
pack: 1



bonbistro

δίσκοι από ξύλο μπαμπού με κείλος  
*bamboo wood trays with rim*

30.71091 24x16 cm | 1,7 cm  
pack: 1

30.71092 32x24 cm | 1,7 cm  
pack: 1



Cosy & Trendy

δίσκοι από ξύλο μπαμπού με κείλος  
*bamboo wood trays with rim*

30.80115 28 cm | 1,8 cm  
pack: 1

30.80427 33 cm | 1,8 cm  
pack: 1



δίσκοι από ξύλο ελιάς | *olive tree trays*



\*27.00876 δίσκος από ξύλο ελιάς  
*olive tree tray*  
25x16 cm (+8 cm)  
pack: 1



34.60085 δίσκος από ξύλο ελιάς  
*olive tree tray*  
38x18 cm  
pack: 1



\*27.01021 δίσκος από ξύλο ελιάς  
*olive tree tray*  
35,5x18,5 cm | 2 cm  
pack: 1



\*27.01022 δίσκος από ξύλο ελιάς  
*olive tree tray*  
39,5x21 cm | 2,5 cm  
pack: 1

σταντ για σουβλάκια | *kebabs stands*



34.60373 σταντ για σουβλάκια  
μαύρο  
*kebabs stand black*  
24 cm | 45 cm  
pack: 1

34.60374 σταντ για σουβλάκια  
copper  
*kebabs stand copper*  
24 cm | 45 cm  
pack: 1

34.60375 δίσκος ξύλινος για  
σταντ για σουβλάκια  
*wooden plate*  
26 cm  
pack: 1



δίσκοι από ξύλο ελιάς | *olive tree trays*

**HENDI** πλατό σερβιρίσματος ορθογώνιο  
από ξύλο ελιάς  
*cutting board rectangular, olive wood*

30.42205 25x15 cm | 1,8 cm  
pack: 1

30.42206 30x15cm | 1,8 cm  
pack: 1

30.42207 35x15 cm | 1,8 cm  
pack: 1

**HENDI** πλατό σερβιρίσματος από ξύλο ελιάς,  
με αυλάκι  
*cutting board with groove, olive wood*

30.42208 30x21cm | 1,8 cm  
pack: 1

**HENDI** πλατό σερβιρίσματος από ξύλο ελιάς,  
με αυλάκι  
*cutting board with groove, olive wood*

30.42209 40x25 cm | 1,8 cm  
pack: 1

**HENDI** πλατό σερβιρίσματος από ξύλο ελιάς,  
με τρύπα  
*cutting board with hole, olive wood*

30.42210 25x16,5 cm | 1,8 cm  
pack: 1

**HENDI** πλατό σερβιρίσματος από ξύλο ελιάς,  
με τρύπα  
*cutting board with hole, olive wood*

30.42211 35x21 cm | 1,8 cm  
pack: 1

**HENDI** πλατό σερβιρίσματος από ξύλο ελιάς,  
με λαβή  
*cutting board with handle, olive wood*

30.42212 35x12 cm | 1,8 cm  
pack: 1

30.42213 40x14 cm | 1,8 cm  
pack: 1





30.42214 60x20 cm | 1,8 cm  
pack: 1

**HENDI** ψωμιέρα από ξύλο ελιάς,  
*bread box, olive wood*

30.42215 24,5x19,8 cm | 19,4 cm  
pack: 1



σκεύη σερβιρίσματος copper | *copper serving utensils*

	<b>APS</b>	27.40616	μπολ copper   <i>copper bowl</i> 9,5 cm   8,5/11,5 cm pack: 1
	<b>APS</b>	27.40617	mug, copper 8,5 cm   8,5 cm pack: 1
	<b>GenWare</b>	34.60002	μπολ σφυρίλατο, copper <i>hammered copper bowl</i> 11,6 cm   9,5 cm pack: 1/24
	<b>APS</b>	27.40618	mug σφυρίλατο, copper <i>hammered copper mug</i> 8,5 cm   8,5 cm pack: 1

«Schale»

	<b>APS</b>		μπολ αλουμινίου, χρυσό <i>aluminium bowl, gold look</i>
		*27.40690	15,5x12 cm   5,5 cm pack: 1
		*27.40693	23x15,5 cm   6 cm pack: 1
	<b>APS</b>		μπολ αλουμινίου, κάλκινο <i>aluminium bowl, copper look</i>
		*27.40691	15,5x12 cm   5,5 cm pack: 1
		*27.40694	23x15,5 cm   6 cm pack: 1
	<b>APS</b>		μπολ αλουμινίου, gunmetal <i>aluminium bowl, gunmetal look</i>
		*27.40692	15,5x12 cm   5,5 cm pack: 1
		*27.40695	23x15,5 cm   6 cm pack: 1

σκεύη σερβιρίσματος copper | *copper serving utensils*

			mini σκεύη copper με τριπλή επίστρωση 2,5 mm χαλκός/αλουμίνιο/stainless steel <i>small copper pans</i> made of 2.5 mm thick 3-ply material, copper/aluminium/stainless steel
			κατοαρολάκια   <i>saucepans</i>
		30.41228	5 cm   3 cm pack: 1
		30.41248	7,5 cm   4 cm pack: 1
		30.41227	8,5 cm   5 cm pack: 1
		30.41226	τηγανάκι   <i>saute pan</i> 12 cm   3 cm pack: 1
	<b>Cosy &amp; Trendy</b>	30.80401	κατοαρόλα με καπάκι <i>casserole with lid</i> 11,5 cm pack: 1
	<b>Cosy &amp; Trendy</b>	30.80403	τηγανάκι   <i>frying pan</i> 11,5 cm pack: 1

σκεύη σφυρίλατα antique | *hammered antique utensils*

	<b>GenWare</b>		κουβαδάκια antique   <i>antique buckets</i>
		34.60256	λευκό   white 10 cm   9 cm pack: 1/12
		34.60096	silver 10 cm   9 cm pack: 1/12
		34.60097	copper 10 cm   9 cm pack: 1/12



σκεύη σερβιρίσματος inox | *inox serving utensils*

	inox κατοαρολάκια <i>st. steel serving cooking pot</i>
	30.71335 9 cm   6 cm pack: 1
	30.71336 12 cm   7 cm pack: 1

	κατοαρολάκια inox   <i>mini saucepans</i>
	*27.40643 14 cl (7 cm   4,5 cm) pack: 1
	*27.40644 36 cl (9 cm   6 cm) pack: 1

	μπολάκι inox με λαβές <i>inox bowl with handles</i>
	30.80030 15 cm   4,5 cm pack: 1

	κουβαδάκια, inox   <i>mini buckets</i>
	34.60024 50 cl (10 cm   9 cm) pack: 1/12
	34.60025 80 cl (12 cm   11 cm) pack: 1/10

	κουβαδάκια με πόδι, inox <i>mini footed buckets</i>
	30.41033 9 cm pack: 1
	30.41034 12 cm pack: 1

	ramekin
	30.41669 6,2 cm   2,4 cm (4 cl) pack: 1
	30.41964 6,2 cm   4 cm (7 cl) pack: 1
	30.41670 7,3 cm   4,7 cm (11,5 cl) pack: 1
	30.41671 8,5 cm   5,2 cm (17,5 cl) pack: 1
	30.41672 9,3 cm   5,8 cm (23 cl) pack: 1
	30.41673 10 cm   7,5 cm (34 cl) pack: 1

	καρδαρίτσες, inox   <i>mini milk churns</i>
	30.41037 4,5 cm   5 cm pack: 1
	30.41038 7 cm   10 cm pack: 1



	30.41031 ταψάκι inox   <i>mini roaster</i> 18,5x9,5 cm   4,5 cm pack: 1
--	---

	σουρωτηράκια, inox   <i>mini colanders</i> 30.41036 13 cm pack: 1
--	---

	30.41754 σουρωτηράκι με πλέγμα <i>colander square perforated</i> 16,9x16,9 cm   5,5 cm pack: 1
--	---

	30.41755 σουρωτηράκι με πλέγμα <i>colander round perforated</i> 16 cm   6,5 cm pack: 1
---	---

	δοχεία «κονσέρβα», inox   <i>inox cans</i>
	34.60257 34 cl (8 cm   8 cm) pack: 1
	34.60258 47 cl (7,8 cm   10,8 cm) pack: 1
	34.60259 1,3 lt (11 cm   14,5 cm) pack: 1
	34.60260 3,6 lt (15,7 cm   17,8 cm) pack: 1

	34.60372 δοχείο «κονσέρβα», inox, μαύρο <i>black inox can</i> 11 cm   14,5 cm (1,3 lt) pack: 1
--	--

σαλτσιέρες | *saucepans*

	σαλτσιέρες αντικολλητικές <i>non-stick saucepans</i> , 15 cl
	34.60376 μαύρη   <i>black</i> pack: 1
	34.60377 κόκκινη   <i>red</i> pack: 1
	34.60378 καφέ   <i>brown</i> pack: 1











«Vintage Steel collection»

 <p>GenWare</p>	<p>πίατο μεταλλικό «Vintage steel»</p> <p>34.60364 20 cm   2 cm pack: 1</p> <p>34.60365 24 cm   4 cm pack: 1</p> <p>34.60379 26 cm   4 cm pack: 1</p>
 <p>GenWare</p>	<p>πίατο μεταλλικό «Vintage steel»</p> <p>34.60366 16x12 cm   3,5 cm pack: 1</p> <p>34.60367 18x13,5 cm   4 cm pack: 1</p> <p>34.60368 20x15 cm   4,5 cm pack: 1</p>
 <p>GenWare</p>	<p>δίσκος μεταλλικός «Vintage steel»</p> <p>34.60369 20x14 cm   2 cm pack: 1</p> <p>34.60370 31,5x21,5 cm   2 cm pack: 1</p> <p>34.60371 37x26,5 cm   2 cm pack: 1</p>
 <p>GenWare</p>	<p>34.60363 ramken 7,1 cl pack: 1/24</p>

σκεύη σερβιρίσματος inox | *inox serving utensils*

 <p>GenWare</p>	<p>δοχείο βασάλτη   <i>terracotta pot</i> να μην έρχεται σε επαφή με τρόφιμα   <i>Terracotta pots should not come into direct contact with food and should be lined with greaseproof paper if ramekin not used.</i></p> <p>34.60006 11,2 cm   9,7 cm pack: 1/12</p> <p>34.60007 δοχείο inox   <i>inox pot</i> 34 cl (εφαρμόζει στο δοχείο βασάλτη   <i>apply to basalt pot</i>) pack: 1/24</p>
 <p>GenWare</p>	<p>34.60001 μπολ σφυρίλατο, inox <i>inox hammered pot</i> 11,6 cm   9,5 cm pack: 1/24</p>
 <p>APS</p>	<p>σφυρίλατα mugs, inox <i>inox hammered mugs</i> 8,5 cm   8,5 cm</p> <p>27.40607 inox pack: 1</p> <p>34.60090 κόκκινο   red pack: 1/24</p> <p>34.60091 μαύρο   black pack: 1/24</p>



 <p>APS</p>	<p>μπολ stainless steel <i>bowl stainless steel</i></p> <p>*27.40707 μαύρο   <i>black</i> 7,5 cm   2,5 cm (5 cl) pack: 1</p> <p>*27.40708 copper red 8,5 cm   5,5 cm (20 cl) pack: 1</p> <p>*27.40711 μαύρο   <i>black</i> 8,5 cm   8,5 cm (40 cl) pack: 1</p>
 <p>APS</p>	<p>μπολ stainless steel διπλού τοιχώματος <i>bowl s/s double wall</i></p> <p>*27.40700 copper red 9,5 cm   4,5 cm (14 cl) pack: 1</p> <p>*27.40703 μαύρο   <i>black</i> 12 cm   6,5 cm (32 cl) pack: 1</p> <p>*27.40704 copper red 17 cm   8,5 cm (90 cl) pack: 1</p>
 <p>APS</p>	<p>δίσκος s/s   <i>stainless steel tray</i> 26,5x16 cm   3 cm</p> <p>*27.40712 copper red pack: 1</p> <p>*27.40713 μαύρος pack: 1</p>









σκεύη σερβιρίσματος αλουμινίου | *aluminium cookware*

 <p>GenWare</p>	<p>mini σκεύη σερβιρίσματος αλουμινίου με ορειχάλκινες λαβές <i>mini aluminium cookware with brass handles</i></p> <p>34.60466 mini κασαρολάκι <i>mini casserole dish</i> 11 cm   7 cm pack: 6</p> <p>34.60467 mini κασαρολάκι <i>mini casserole dish</i> 15 cm   4 cm pack: 6</p> <p>34.60468 mini τηγανάκι <i>mini frying pan</i> 15 cm   6 cm pack: 6</p>
---	--





συρμάτινα σκεύη | *wired serving utensils*

συρμάτινα σκεύη μαύρα | *wired serving utensils*





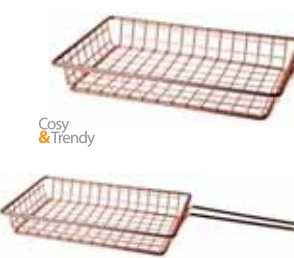

	<p><b>30.41039</b> καλαθάκι φριτέζας <i>deep frying basket</i> 10x8 cm   7,5 cm pack: 1</p> <p><b>30.41040</b> καλαθάκι φριτέζας <i>deep frying basket</i> 12,5x10 cm   8,5 cm pack: 1</p>		<p><b>30.41771</b> καλαθάκι φριτέζας <i>deep frying basket</i> 10x8 cm   7,5 cm pack: 1</p> <p><b>30.41772</b> καλαθάκι φριτέζας <i>deep frying basket</i> 12,5x10 cm   8,5 cm pack: 1</p>
	<p><b>30.41042</b> καλαθάκι φριτέζας <i>deep frying basket</i> 25,5x13,5 cm   4,5 cm pack: 1</p>		<p><b>30.41774</b> καλαθάκι φριτέζας <i>deep frying basket</i> 25,5x13,5 cm   4,5 cm pack: 1</p>
	<p><b>30.41041</b> καλαθάκι φριτέζας <i>deep frying basket</i> 9 cm   9 cm pack: 1</p>		<p><b>30.41773</b> καλαθάκι φριτέζας <i>deep frying basket</i> 9 cm   9 cm pack: 1</p>
	<p><b>30.41775</b> καλαθάκι φριτέζας στοιβαζόμενο <i>deep frying basket stackable</i> 10,5x9 cm   6 cm pack: 1</p> <p><b>30.41777</b> καλαθάκι φριτέζας στοιβαζόμενο <i>deep frying basket stackable</i> 13x11,5 cm   8 cm pack: 1</p>		<p><b>30.41776</b> καλαθάκι φριτέζας στοιβαζόμενο <i>deep frying basket stackable</i> 10,5x9 cm   6 cm pack: 1</p> <p><b>30.41778</b> καλαθάκι φριτέζας στοιβαζόμενο <i>deep frying basket stackable</i> 13x11,5 cm   8 cm pack: 1</p>

σκεύη συρμάτινα inox μαύρα | *inox wired black utensils*

σκεύη συρμάτινα copper | *copper wired utensils*

	<p>συρμάτινα καλάθια black metall <i>fry baskets</i></p> <p><b>30.80263</b> 12 cm   8 cm pack: 1</p> <p><b>30.80398</b> 10,5 cm   7,7 cm pack: 1</p>		<p>συρμάτινο καλάθι   <i>fry basket</i></p> <p><b>30.80399</b> 14x14 cm   7,5 cm pack: 1/12</p>
	<p>συρμάτινο καλάθι ορθογώνιο μαύρο <i>rectangular wired black fry basket</i></p> <p><b>30.80397</b> 12x10 cm   8,5 cm pack: 1</p>		<p>συρμάτινο καλάθι (χοντρό σύρμα) <i>fry basket</i></p> <p><b>30.80489</b> 24,5x15 cm   4 cm pack: 1</p>

σκεύη συρμάτινα inox | *inox wired utensils*



	<p>συρμάτινο καλάθι οβάλ μαύρο με θέσεις για 2 ντιπ <i>rectangular wired black basket with 2 inserts for dip</i></p> <p>*27.40604 39,5x20 cm   11 cm pack: 1</p>
	<p>βάση για σακουλάκι chips, μαύρη <i>chips bag holder, black matt</i></p> <p>30.41720 11,5 cm   10 cm pack: 1</p>
	<p>συρμάτινος κώνος μαύρος με θέση για ντιπ (8 cm) <i>wired black cone (fits ramekin 8 cm)</i></p> <p>30.41556 21x11 cm   17,2 cm pack: 1</p>
	<p>συρμάτινος κώνος μαύρος <i>wired black cone</i></p> <p>30.41719 11,5 cm   17,2 cm pack: 1</p>
	<p>συρμάτινος κώνος <i>wired cone</i></p> <p>30.80038 12 cm   22 cm pack: 1</p>
	<p>βάση για σακουλάκι chips <i>chips bag holder</i></p> <p>30.40112 11 cm   17,5 cm pack: 1</p>





«μυστρί» σερβιρίσματος | *serving «trowel»*

	<p>«μυστρί» σερβιρίσματος <i>serving «trowel»</i></p> <p>*27.40681 μαύρο   <i>black</i> 23,5x15,5 cm   13 cm pack: 1</p> <p>*27.40680 inox 23,5x15,5 cm   13 cm pack: 1</p>
--	---

ραμκέν | *ramekin*

	<p>σετ 4 ραμκέν μελαμίνης <i>melamine ramekin (set of 4)</i></p> <p>30.41281 5,8 cm   2,7 cm pack: 4</p> <p>30.42227 6 cm   2,5 cm pack: 4</p> <p>30.41282 7 cm   3,7 cm pack: 4</p>
	<p>σετ 12 ραμκέν Ρ.Ε., 6 cm   3,5 cm <i>ramekin (set of 12)</i></p> <p>30.41277 μαύρο   <i>black</i> pack: 6</p> <p>30.41278 ιβουάρ   <i>ivory</i> 6 cm   3,5 cm pack: 6</p>

καλάθια hamburger | *hamburger baskets*

	<p>σετ 6 καλάθια PP για hamburger <i>set of 6 hamburger baskets, PP</i> 23x14 cm   4 cm</p> <p>30.80095 μαύρα   <i>black</i> pack: 1</p> <p>30.80096 κόκκινα   <i>red</i> pack: 1</p>
	<p>σετ 6 καλάθια PP για hamburger <i>set of 6 hamburger baskets, PP</i> 27,5x17,5cm   3,8 cm</p> <p>30.42198 καφέ   <i>brown</i> pack: 1</p> <p>30.42200 μαύρα   <i>black</i> pack: 1</p> <p>30.42199 κόκκινα   <i>red</i> pack: 1</p>





σκεύη γαλβανιζέ | *galvanised steel utensils*

	<p><b>GenWare</b></p> <p>34.60035 δοχείο γαλβανιζέ <i>galvanised bowl</i> 15 cm   8 cm pack: 1/12</p>
--	---

	<p><b>GenWare</b></p> <p>34.60099 δοχείο γαλβανιζέ οβάλ <i>oval galvanised bowl</i> 15,5x11 cm   8,5 cm pack: 1/12</p>
--	--

	<p><b>GenWare</b></p> <p>34.60036 δοχείο γαλβανιζέ οβάλ <i>oval galvanised bucket</i> 23x15 cm   7 cm pack: 1/12</p>
--	--

	<p><b>GenWare</b></p> <p>34.60038 δοχείο γαλβανιζέ οβάλ <i>oval galvanised bucket</i> 24x15 cm   5 cm pack: 1/36</p>
--	--

	<p><b>GenWare</b></p> <p>34.60100 δοχείο γαλβανιζέ ορθογ. <i>rectangular galvanised bucket</i> 23x15 cm   7 cm pack: 1</p>
--	--

	<p><b>GenWare</b></p> <p>34.60069 δοχείο γαλβανιζέ ορθογ. <i>rectangular galvanised bucket</i> 24,5x15,5 cm   12,5 cm pack: 1/24</p>
--	--



	<p><b>GenWare</b></p> <p>κουβαδάκι γαλβανιζέ με 2 λαβές <i>mini bin with 2 handles</i> 34.60132 8,5 cm   11,2 cm pack: 1</p>
--	--

	<p><b>GenWare</b></p> <p>34.60040 δοχείο γαλβανιζέ <i>galvanised can</i> 11 cm   14,5 cm pack: 1</p>
--	--

	<p><b>HENDI</b></p> <p>διπλό κουβαδάκι με χέρι, γαλβανιζέ <i>double buckets with handle</i> 30.41628 10x20 cm pack: 1 30.41548 12x24 cm pack: 1</p>
--	---

	<p><b>HENDI</b></p> <p>κουβαδάκια με χέρι, γαλβανιζέ <i>buckets with handle</i> 30.41600 7 cm   6,5 cm pack: 1 30.41550 10 cm   9 cm pack: 1 30.41549 12 cm   10,5 cm pack: 1 30.41961 16 cm   14 cm pack: 1</p>
--	--

λαδόκολλες | greaseproof papers

	<p>30.41999 προδιαμορφωμένη λαδόκολλα για καλάθια (σετ 150 τμχ.) greaseproof paper lining pre-shaped (set of 150) 16x16 cm   50 cm pack: 1</p>
---	--



λαδόκολλες | greaseproof papers

	<p>λαδόκολλα «εφημερίδα» (σετ 500 τμχ.) greaseproof paper «Newspaper» (set of 500)</p>
	<p>30.41987 25x35 cm pack: 1</p>
	<p>30.41265 20x25 cm pack: 1</p> <p>λαδόκολλα μπεζ (σετ 500 τμχ.) greaseproof papers beige (set of 500)</p> <p>30.41998 25x35 cm pack: 1</p> <p>30.41266 20x25 cm pack: 1</p>

λαδόκολλες | greaseproof papers

	<p>30.41947 λαδόκολλα «καρό» (σετ 500 τμχ.) greaseproof paper «checked pattern» (set of 500) 30,6x30,5 cm pack: 1</p>
	<p>λαδόκολλα «κενό» (σετ 500 τμχ.) greaseproof paper «neutral» (set of 500)</p> <p>30.41952 25x20 cm pack: 1</p> <p>30.41950 26,3x38 cm pack: 1</p> <p>30.41948 30,6x30,5 cm pack: 1</p>
	<p>λαδόκολλα «chef food» (σετ 500 τμχ.) greaseproof paper «chef food» (set of 500)</p> <p>30.41951 25x20 cm pack: 1</p> <p>30.41946 30,6x30,5 cm pack: 1</p>
	<p>λαδόκολλα «kitchen mayhem» (σετ 500 τμχ.) greaseproof paper «kitchen mayhem» (set of 500)</p> <p>30.41949 25,8x42,5 pack: 1</p>

λαδόκολλες σουπλά | greaseproof papers placemat

	<p>30.41954 λαδόκολλα σουπλά «κουζίνα» (σετ 500 τμχ.) greaseproof papers placemat «kitchen» (set of 500) 42x27,5 cm pack: 1</p>
	<p>30.41955 λαδόκολλα σουπλά «καρό» (σετ 500 τμχ.) greaseproof papers placemat «pattern» (set of 500) 42x27,5 cm pack: 1</p>



μαντεμμένα σκεύη | *cast iron dishes*



KitchenCraft

cast iron sizzle platter on wooden stand  
35.00041 35/24x14 cm | 2,4 cm  
pack: 1/6

GenWare



μαντεμμένο σκεύος με ξύλινη βάση  
cast iron sizzle platter on wooden stand

34.60137 σαχάνι/platter: 25x16 cm  
31x18,5 cm  
pack: 1

34.60138 σαχάνι/platter: 28x18 cm  
33x21 cm  
pack: 1



Cosy & Trendy

μαντεμμένο σκεύος με ξύλινη βάση  
cast iron sizzle platter on wooden stand

30.80081 22 cm  
pack: 1



Cosy & Trendy

μαντεμμένο σκεύος με ξύλινη βάση  
μαντεμμένο σαγάνι με ξύλινη βάση  
cast iron eared dish on wooden stand

30.80076 20/15x10 cm  
pack: 1



Cosy & Trendy

μαντεμμένο σαγάνι οβάλ με ξύλινη βάση  
cast iron oval eared dish on wooden stand

30.80428 30x17 cm | 5 cm  
pack: 1



Cosy & Trendy

μαντεμμένο σαγάνι με ξύλινη βάση  
cast iron eared dish on wooden stand

30.80075 12x16,5 cm  
pack: 1



Cosy & Trendy

μαντεμμένο σαγάνι με ξύλινη βάση  
cast iron eared dish on wooden stand

30.80079 16x22,5 cm  
pack: 1



Cosy & Trendy

μαντεμμένο grill με ξύλινη βάση  
cast iron grill pan on wooden stand

30.80491 15x15 cm | 12 cm  
pack: 1



53.10013 μαντεμμένο σκεύος ψαριού  
cast iron fish dish  
15x29 cm  
pack: 1

53.10014 ξύλινη βάση | wooden base  
15x29 cm  
pack: 1

μαντεμμένο τηγάνι με ξύλινη βάση  
cast iron frying pan on wooden stand  
35.02418 13,4x20 cm | 3,4 cm  
pack: 1

μαντεμμένο τηγάνι με ξύλινη βάση  
cast iron frying pan on wooden stand  
35.02420 12,5x10,5 cm | 2,5 cm  
pack: 1

μαντεμμένο τηγάνι με ξύλινη βάση  
cast iron frying pan on wooden stand  
35.02367 14,3x24 cm | 2,7 cm  
pack: 1

μαντεμμένο κατσαρόλι με ξύλινη βάση  
cast iron pan dish on wooden stand  
30.80404 30x22 cm  
pack: 1

μαντεμμένο κατσαρόλι με ξύλινη βάση  
cast iron casserole on wooden stand  
30.80077 11,8 cm  
pack: 1



μαντεμίνια σκεύη | *cast iron dishes*

	<b>Silver</b> 53.10009	μαντεμίνιο πλατώ <i>cast iron platter</i> 15x22 cm pack: 1
	53.10010	ξύλινη βάση   <i>wooden base</i> 15x22 cm pack: 1
	<b>Silver</b> 53.10011	μαντεμίνιο πλατώ <i>cast iron platter</i> 21x37 cm pack: 1
	53.10012	ξύλινη βάση   <i>wooden base</i> 23x39cm pack: 1
	<b>Silver</b> 53.10017	μαντεμίνιο πλατώ <i>cast iron fish dish</i> 20,4x30,3 cm pack: 1
	53.10018	ξύλινη βάση   <i>wooden base</i> 21x31 cm pack: 1
	<b>Silver</b> 53.10019	μαντεμίνιο πλατώ <i>cast iron fish dish</i> 24x33,1 cm pack: 1
	53.10020	ξύλινη βάση   <i>wooden base</i> 24x33 cm pack: 1



	<b>Silver</b> 53.10015	μαντεμίνιο τηγάνι <i>cast iron pan</i> 28 cm pack: 1
	<b>Silver</b> 53.10016	μαντεμίνιος δίσκος pizza <i>cast iron pizza pan</i> 28 cm pack: 1
	<b>GenWare</b> 34.60263	μαντεμίνιο σαχάνι <i>cast iron eared dish</i> 27x17,3 cm pack: 1
	<b>GenWare</b> 34.60264	μαντεμίνιο wok <i>cast iron wok</i> 17/22 cm   5,3 cm pack: 1
	<b>GenWare</b> 34.60262	μαντεμίνιο τηγάνι <i>cast iron frying pan</i> 20/30 cm   3,4 cm pack: 1
	<b>GenWare</b> 34.60261	μαντεμίνια κατοαρόλα <i>cast iron casserole</i> 13,5 cm   6,6 cm pack: 1
	<b>GenWare</b> 34.60265	μαντεμίνιο ραμκέν <i>cast iron ramekin</i> 8 cl pack: 1













Cosy & Trendy

	30.80495	tajine cast iron <i>cast iron tajine</i> 25 cm pack: 1
---	----------	---













mini σκεύη πορσελάνης | *mini porcelain utensils*

	<p>σετ 6 μπολ τετράγωνα <i>square bowls (set of 6)</i> 30.41091 8x8 cm   3,5 cm pack: 1</p>		<p>σετ 6 μπολ τρίγωνα <i>triangle bowls (set of 6)</i> 30.41097 10x10 cm   2,5 cm pack: 1</p>
	<p>σετ 6 μπολ στρογγυλά <i>round bowls (set of 6)</i> 30.41094 7,5 cm   3 cm pack: 1</p>		<p>σετ 6 μπολ «σαγάνι» <i>eared dish (set of 6)</i> 30.41095 6,5 cm   1,5 cm pack: 1</p>
	<p>σετ 6 μπολ στρογγυλά «Leon» <i>round bowls (set of 6)</i> 30.41100 5,5 cm   4,5 cm pack: 1</p>		<p>σετ 6 κατσαρολάκια <i>tapas caserole (set of 6)</i> 30.41096 6 cm   2,5 cm pack: 1</p>
	<p>σετ 6 μπολ οβάλ «Concha» <i>oval bowls (set of 6)</i> 30.41092 9x5 cm   2 cm pack: 1</p>		<p>σετ 6 πιατάκια <i>tapas plato (set of 6)</i> 30.41099 10 cm   2,5 cm pack: 1</p>
	<p>σετ 6 μπολ τετράγωνα βαθιά <i>square deep bowls (set of 6)</i> 30.41098 5,9x5,9 cm   3,7 cm pack: 1</p>		<p>σετ 6 κουτάλια   <i>spoons (set of 6)</i> 30.41101 13,3x4,3 cm   2,6 cm pack: 1</p>

πορσελάνης «black & white» porcelain

bon**bistro**

	<p>30.71105 μπολ λευκό   <i>white bowl</i> 4,8 cm   2 cm pack: 1</p>
	<p>30.71104 μπολ μαύρο   <i>black bowl</i> 4,8 cm   2 cm pack: 1</p>
	<p>30.71106 μπολ λευκό   <i>white bowl</i> 7,5 cm   3,8 cm pack: 1</p>
	<p>30.71111 μπολ μαύρο   <i>black bowl</i> 7,5 cm   3,8 cm pack: 1</p>
	<p>30.71110 μπολ λευκό   <i>white bowl</i> 9 cm   5 cm pack: 1</p>
	<p>30.71109 μπολ μαύρο   <i>black bowl</i> 9 cm   5 cm pack: 1</p>
	<p>μπολ ψηλό   <i>high bowl</i> 30.71108 λευκό   <i>white</i> 5 cm   8,5 cm pack: 1</p>
	<p>30.71107 μαύρο   <i>black</i> 5 cm   8,5 cm pack: 1</p>
	<p>σαλτσιέρες   <i>sause boats</i> 30.71112 4 cl pack: 1</p>
	<p>30.71113 8 cl pack: 1</p>
	<p>30.71114 19 cl pack: 1</p>

αποθηκεύονται  
η μία μέσα στην άλλη  
*Stored one inside the other*

mini σκεύη πορσελάνης | *mini porcelain utensils*



	<p> σετ 6 πιατάκια κυματιστά <i>small dishes (set of 6)</i> 30.80247 9x6 cm pack: 1</p>
	<p>σετ 6 πιατάκια δάκρυ <i>small dishes «teardrop» (set of 6)</i> 30.80249 6,9x9,7 cm pack: 1</p>
	<p>σετ 4 μπολάκια με χέρι <i>small bowls with handle (set of 4)</i> 30.80248 6x8 cm   3,6 cm pack: 1</p>
	<p>σετ 3 κατσαρολάκια <i>small casserole (set of 3)</i> 30.80250 7x9,5 cm   3,3 cm pack: 1</p>
	<p>σετ 6 κατσαρολάκια <i>small casserole (set of 6)</i> 30.80253 6 cm pack: 1</p>
	<p>σετ 6 μπολάκια stoneware <i>stoneware bowls (set of 6)</i> 30.80252 6,5 cm   3,5 cm pack: 1</p>
	<p>30.80264 σετ 6 πιατάκια stoneware <i>stoneware dish, set of 6</i> 6,2/8,5x2,9/5cm pack: 1</p>
	<p>30.80497 σαλτσιέρα πορσελάνης <i>porcelain saucepan</i> 10,3 cm   9,7 cm pack: 1 </p>



σκεύη πυρίμαχης πορσελάνης | *fire proof porcelain*

	γιουβetoάκι με χερούλι, μαύρο ματ <i>small rustic round dish with handle, black</i> 96.10030 14 cm pack: 1
	γιουβetoάκι, μαύρο ματ <i>small rustic round dish, black mat</i> 96.10031 16 cm pack: 1
	σαγανάκι, μαύρο ματ <i>rustic eared dish, black mat</i> 96.10032 17 cm pack: 1
	σαγανάκι οβάλ, μαύρο ματ <i>rustic eared oval dish, black mat</i> 96.10033 24 cm pack: 1
	σαγανάκι στρογγυλό, μαύρο ματ <i>rustic eared dish, black mat</i> 96.10034 15 cm pack: 1
	96.10035 joker, μαύρο ματ <i>joker black mat</i> 6 cm pack: 1













σκεύη γυάλινα πυρίμαχα | *fire proof glass*

 	90.91814 σαγανάκι γυάλινο πυρίμαχο <i>fire proof glass pot</i> 15 cm pack: 6
--	--

σκεύη παρουσίασης stoneware | *stoneware utensils*  
*Cast Iron effect*

 	34.60133 ταψάκι   <i>rectangular dish</i> 16x10,5 cm   4 cm pack: 1
	34.60134 ταψάκι   <i>oval dish</i> 17,5x11,5 cm   4 cm pack: 1
	34.60135 ταψάκι   <i>oval dish</i> 14,5x13 cm   3 cm pack: 1
	34.60136 wok 15 cm pack: 1

σκεύη πυρίμαχης πορσελάνης | *fire proof porcelain*









	γιουβetoάκια ρουστίκ, καφέ <i>small rustic round dish</i> 96.10005 14 cm pack: 12 96.10008 16 cm pack: 12
	γιουβetoάκι ρουστίκ, καφέ με χέρια <i>small rustic round dish with handle</i> 96.10006 14 cm pack: 12
	γιουβetoάκι ρουστίκ, καφέ με χέρια <i>small rustic round dish with handle</i> 96.10029 15 cm pack: 12
	γιουβetoάκι ρουστίκ, καφέ με χέρια <i>small rustic round dish with handle</i> 96.10012 16 cm pack: 12 96.10013 καπάκι   <i>lid</i> , 16 cm pack: 12
	σαγανάκι ρουστίκ, καφέ <i>rustic eared dish</i> 96.10009 17 cm pack: 12
	σαγανάκι ρουστίκ, οβάλ, καφέ <i>oval rustic eared dish</i> 96.10010 22x14 cm pack: 12 96.10011 24x15 cm pack: 12
	96.10015 joker, καφέ   <i>brown</i> , 6 cm pack: 12
	96.10014 joker, λευκό   <i>white</i> , 6 cm pack: 12
	96.10028 joker, μαύρο   <i>black</i> , 6 cm pack: 12
	ραμκέιν   <i>ramekins</i> 96.10016 καφέ   <i>brown</i> , 9 cm pack: 12
	96.10017 λευκό   <i>white</i> , 9 cm pack: 12
	96.10026 μαύρο   <i>black</i> , 9 cm pack: 12





σκεύη εμαγιέ | *enamel utensils*

 	<p><b>APS</b> εμαγιέ κατσαρόλες για μύδια <i>enamel mussel pots</i></p> <p>27.00623 για/for 0,5 Kgr 13,5 cm   9 cm pack: 1</p> <p>27.00625 για/for 1 Kgr 18 cm   12 cm pack: 1</p> <p>27.00626 για/for 1,5 Kgr 20 cm   13 cm pack: 1</p> <p>27.00627 για/for 2 Kgr 24 cm   13,5 cm pack: 1</p>		<p>30.40195 <b>HENDI</b> <i>mini</i> χύτρα, μαύρη <i>mini pot, black</i> 13,5 cm   10,3 cm pack: 1</p>
	<p><b>Cosy &amp; Trendy</b> εμαγιέ κατσαρόλες για μύδια <i>enamel mussel pots</i></p> <p>30.80045 12 cm pack: 1</p> <p>30.80044 18 cm pack: 1</p>		<p>30.40194 <b>HENDI</b> <i>mini</i> χύτρα, μπλε <i>mini pot, blue</i> 12 cm   9,5 cm pack: 1</p>
	<p><b>Cosy &amp; Trendy</b> εμαγιέ κατσαρόλα για μύδια <i>enamel mussel pot</i></p> <p>30.80031 <i>μπλε   blue</i> 18 cm (2,8 lt) pack: 1</p>		<p>εμαγιέ κατσαρόλες για μύδια <i>enamel mussel pots</i></p> <p>30.41728 0,8 lt (12,5 cm   14,5 cm) pack: 1</p> <p>30.41043 1,2 lt (19 cm   19 cm) pack: 1</p> <p>30.41044 1,6 lt (21 cm   20 cm) pack: 1</p>
		<p><b>HENDI</b> <i>mini</i> μπολ παέγιας εμαγιέ <i>enamel bowls</i></p> <p>30.41310 14,5 cm   4 cm pack: 1</p> <p>30.41311 17 cm   4 cm pack: 1</p> <p>30.41312 18,5 cm   4,3 cm pack: 1</p> <p>30.41313 20,5 cm   5,7 cm pack: 1</p> <p>30.40200 24,5 cm   7 cm pack: 1</p>	
		<p><b>HENDI</b> <i>mini</i> τηγάνια παέγιας <i>enamel paella pans</i></p> <p>30.41753 10 cm   2 cm pack: 1</p> <p>30.40196 12 cm   2,5 cm pack: 1</p> <p>30.40197 15 cm   2,7 cm pack: 1</p> <p>30.40198 20 cm   3,6 cm pack: 1</p> <p>30.40199 24 cm   4 cm pack: 1</p>	

	<p>πίατα ρηχά εμαγιέ   <i>enamel plates</i></p> <p>30.41253 20 cm pack: 12</p> <p>30.41254 24 cm pack: 12</p>		<p>μυγ εμαγιέ   <i>enamel mugs</i></p> <p>30.41260 36 cl (9 cm   8 cm) pack: 12</p> <p>30.41261 52 cl (10 cm   9 cm) pack: 12</p>
	<p>πίατα βαθιά εμαγιέ   <i>enamel deep plates</i></p> <p>30.41255 18 cm pack: 12</p> <p>30.41256 20 cm pack: 12</p> <p>30.41257 22 cm pack: 12</p> <p>30.41258 24 cm pack: 12</p>		<p>φλιτζάνι εμαγιέ   <i>enamel cup</i></p> <p>30.41262 12 cl (7 cm   5 cm) pack: 12</p>
	<p>μπολ στρογγυλό εμαγιέ   <i>enamel round bowl</i></p> <p>30.41259 μπολ στρογγυλό εμαγιέ 16 cm pack: 12</p>		<p>ποτήρι εμαγιέ   <i>enamel tumbler</i></p> <p>30.41264 30 cl (9 cm   9 cm) pack: 6</p> <p>30.41263 40 cl (9 cm   12 cm) pack: 6</p>
	<p>μπολ ορθογώνια εμαγιέ   <i>enamel rectangular bowls</i></p> <p>30.41251 17,5x13 cm pack: 12</p> <p>30.41252 21,5x16 cm pack: 12</p>		



Marlux France was founded in 1875 and belongs to De Buyer from 2016. Durable and reliable pepper mills are equipped stainless steel mechanism while salts mills with ss 10/18.



Ξύλινοι μύλοι πιπεριού | *wodden pepper mills*

διατίθενται και με μηχανισμό αλατιού

«Java» natural

- \*25.00443 21 cm  
P247.210101 pack: 1
- \*25.00436 25 cm  
P249.250101 pack: 1
- \*25.00445 30 cm  
P253.300101 pack: 1
- \*25.00446 40 cm  
P251.400101 pack: 1



«Java» dark brown

- 25.00615 21 cm  
P247.210404 pack: 1
- 25.00617 30 cm  
P253.300404 pack: 1
- 25.00616 40 cm  
P251.400404 pack: 1



«Java» black

- \*25.00432 21 cm  
P247.210404 συσκ.: 1
- \*25.00434 25 cm  
P249.250404 συσκ.: 1
- \*25.00645 30 cm  
P253.300404 συσκ.: 1



Ξύλινοι μύλοι αλατιού πιπεριού  
*wodden pepper or salt mills*



«Florentine»

μύλοι πιπεριού/αλατιού  
*pepper or salt mills*

- \*05.80005 κόκκινος | red  
104/50/300 50 cm  
pack: 1
- \*05.80020 μπλε | blue  
104/50/300 50 cm  
pack: 1
- \*05.80001 κόκκινος | red  
104/36/300 36 cm  
pack: 1
- \*05.80017 μπλε | blue  
104/36/300 36 cm  
pack: 1
- \*05.80008 πράσινος | green  
104/25/300 28 cm



«Classic Blue»

- \*05.80006 50 cm  
105/50ALBL pack: 1
- \*05.80009 36 cm  
105/36ALBL pack: 1
- \*05.80003 28 cm  
105/25ALBL pack: 1



«Mahogany Brass»

- \*05.80007 50 cm  
106/50 OT M pack: 1
- \*05.80018 36 cm  
106/36 OT M pack: 1
- \*05.80019 28 cm  
106/25 OT M pack: 1



«Mahogany Brass»

- 05.80002 50 cm  
105/50 AL M pack: 1
- 05.80004 36 cm  
105/36 AL M pack: 1
- \*05.80011 28 cm  
105/25 AL M pack: 1

KitchenCraft

μύλοι με κεραμικό μηχανισμό  
*mills with ceramic grinding mechanisms*

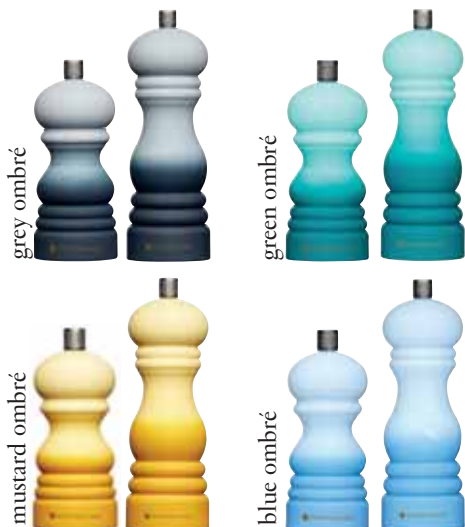

- 35.03436 «mustard ombré», 12 cm  
pack: 6
- 35.03437 «mustard ombré», 17 cm  
pack: 6
- 35.03360 «blue ombré», 12 cm  
pack: 6
- 35.03434 «blue ombré», 17 cm  
pack: 6
- 35.03433 «grey ombré», 12 cm  
pack: 6
- 35.03348 «grey ombré», 17 cm  
pack: 6
- 35.03359 «green ombré», 12 cm  
pack: 6
- 35.03435 «green ombré», 17 cm  
pack: 6



 <p><b>APS</b></p>	<p>μύλοι πιπεριού τοιμεντένιοι με ξύλο <i>concrete pepper mills with wood</i> 6 cm   18 cm</p> <p>*27.40538 μύλος πιπεριού με μηχανισμό carbon steel <i>pepper mill, carbon steel grinder</i> pack: 1</p> <p>*27.40539 μύλος αλατιού με μηχανισμό inox <i>salt mill, inox mechanism</i> pack: 1</p>	 <p><b>PKS</b></p>	<p>μύλοι πιπεριού rubber wood, με κεραμικό μηχανισμό <i>pepper mills rubber wood, with ceramic grinder</i></p> <p>60.58095 φυσικό   <i>natural</i>, 10 cm pack: 1/48</p> <p>60.58102 καφέ   <i>brown</i>, 10 cm pack: 1/48</p>
 <p><b>APS</b></p>	<p>μύλοι πορσελάνης   <i>porcelain mills</i> 5,5 cm   18 cm</p> <p>*27.40559 μύλος πιπεριού με μηχανισμό carbon steel <i>pepper mill, carbon steel grinder</i> pack: 1</p> <p>*27.40560 μύλος αλατιού με μηχανισμό inox <i>salt mill, inox grinder</i> pack: 1</p>	 <p><b>PKS</b></p>	<p>μύλοι πιπεριού rubber wood, με ανοξείδωτο μηχανισμό <i>pepper mills rubber wood, with inox grinder</i></p> <p>60.58096 φυσικό   <i>natural</i>, 15 cm pack: 1/48</p> <p>60.58097 φυσικό   <i>natural</i>, 20 cm pack: 1/36</p> <p>60.58098 φυσικό   <i>natural</i>, 25 cm pack: 1/36</p> <p>60.58099 φυσικό   <i>natural</i>, 30 cm pack: 1/24</p>
 <p><b>APS</b></p>	<p>μύλοι μεταλλικοί, inox <i>stainless steel mills</i> 6 cm   15,5 cm</p> <p>*27.40555 μύλος πιπεριού με μηχανισμό carbon steel <i>pepper mill, carbon steel grinder</i> pack: 1</p> <p>*27.40556 μύλος αλατιού με μηχανισμό inox <i>salt mill, inox grinder</i> pack: 1</p>	 <p><b>PKS</b></p>	<p>μύλοι πιπεριού rubber wood, με μηχανισμό carbon steel <i>pepper mills rubber wood, with carbon steel grinder</i></p> <p>60.58103 καφέ   <i>brown</i>, 15 cm pack: 1/48</p> <p>60.58104 καφέ   <i>brown</i>, 20 cm pack: 1/36</p> <p>60.58105 καφέ   <i>brown</i>, 25 cm pack: 1/36</p> <p>60.58106 καφέ   <i>brown</i>, 30 cm pack: 1/24</p>
 <p><b>PKS</b></p>	<p>60.58115 μύλος ακρυλικός με κεραμικό μηχανισμό <i>acrylic mill with ceramic grinder</i>; 16 cm pack: 1</p> <p>60.58116 μύλος ακρυλικός με st. steel μηχανισμό <i>acrylic mill with st. steel grinder</i>; 16 cm pack: 1</p>	 <p><b>PKS</b></p>	<p>μύλοι πιπεριού ξύλινοι μαύροι ματ, με κεραμικό μηχανισμό <i>pepper mills wooden, black matte, with ceramic grinder</i></p> <p>60.58117 10 cm pack: 48</p> <p>60.58118 15 cm pack: 48</p>
 <p><b>PKS</b></p>	<p>μύλοι πιπεριού ακρυλικοί με κεραμικό μηχανισμό <i>acrylic pepper mills with ceramic mechanism</i></p> <p>60.58110 10 cm pack: 1/48</p> <p>60.58112 13 cm pack: 1/48</p> <p>μύλοι πιπεριού ακρυλικοί με inox μηχανισμό <i>acrylic pepper mills with inox mechanism</i></p> <p>60.58111 15 cm pack: 1/48</p> <p>60.58113 20 cm pack: 1/48</p>	 <p><b>PKS</b></p>	<p>μύλοι πιπεριού ξύλινοι μαύροι ματ, με μηχανισμό carbon steel <i>pepper mills wooden, black matte, with carbon steel grinder</i></p> <p>60.58119 15 cm pack: 48</p> <p>60.58120 20 cm pack: 36</p> <p>60.58121 25 cm pack: 36</p> <p>60.58122 30 cm pack: 24</p> <p>60.58123 40 cm pack: 24</p>

Λαδόξυδα | *cruet set and stands*

Λαδόξυδα | *cruet set and stands*

ΠΙΝΤΙΝΟΧ



«Taste»  
αντιολισθητική βάση inox και  
γυάλινες φιάλες  
*inox non-slip base and glass*



\*19.39018 αλατοπίπερο |  
*salt and pepper menage*  
10x6 cm | 13 cm  
pack: 1



\*19.39019 λαδόξυδο |  
*oil and vinegar menage*  
15x8 cm | 20 cm  
pack: 1

\*19.36020 λαδόξυδο & αλατοπίπερο  
*salt and pepper and  
oil and vinegar menage*  
17x10 cm | 20 cm  
pack: 1

APS



«Element»  
βάση από τοιμνέτο, γυάλινες φιάλες  
με inox πόμματα και inox λαβές  
*stand made of concrete, glass with stainless  
steel cover and inox handle*

\*27.40410 αλατοπίπερο |  
*salt and pepper menage*  
10x6 cm | 17 cm  
pack: 1

\*27.40411 λαδόξυδο |  
*oil and vinegar menage*  
14x8 cm | 25 cm  
pack: 1

\*27.40412 λαδόξυδο & αλατοπίπερο  
*salt and pepper and  
oil and vinegar menage*  
12,5x12,5 cm | 25 cm  
pack: 1

HENDI



30.40351 σετ 2 θέσεων (αλατοπίπερο)  
*set 2 pcs (salt, pepper)*  
8,5x5,5 cm | 11,5 cm  
pack: 1



30.40350 σετ 3 θέσεων (αλατοπίπερο  
& θήκη χαρτοπετσετών)  
*set 3 pcs (salt, pepper, napkins)*  
8,5x7,5 cm | 11,5 cm  
pack: 1



30.40348 σετ λαδόξυδο  
*set oil & vinegar, 15 cl*  
pack: 1/6



30.41002 σετ 4 θέσεων  
(λαδόξυδο & αλατοπίπερο)  
*set 4 pcs  
(oil, vinegar, salt, pepper)*  
13x11 cm | 18,5 cm  
pack: 1



30.40349 σετ 5 θέσεων  
(λαδόξυδο, αλατοπίπερο &  
θήκη οδοντογλυφιδών)  
*set 5 pcs (oil, vinegar, salt,  
pepper, toothpicks holder)*  
13x11 cm | 18,5 cm  
pack: 1



Ξύλινο σετ βάση και σέσουλες  
για αλατοπίπερο  
*wooden set scoops & base for salt & pepper*

30.80094 13,5x7 cm  
pack: 1



27.40507 σετ αλατιέρα/πιπεριέρα  
γυάλινα με inox καπάκι  
*glass set salt & pepper with  
inox lid*  
6 cm | 10 cm  
pack: 1



91.00057 αλατιέρα «Aifel»  
*salt shaker*  
35 ml  
pack: 1/24



60.39603 αλατιέρα γυάλινη  
*salt shaker*  
pack: 1/22



\*27.40503 σετ 4 μικρές αλατιέρες  
*set of 4 small salt shakers*  
pack: 1



60.80040 σετ αλατιέρα/πιπεριέρα  
inox  
*inox set salt & pepper*  
3 cm | 8 cm  
pack: 1/120



φιάλες λαδιού γυάλινες | oil/vinegar bottles



γυάλινες φιάλες λαδιού  
glass oil bottles

00.70052 «Fiori», 50 cl  
26,1 cm  
pack: 12

00.70000 «Assisi», 72 cl  
8,1 cm | 28,5 cm  
pack: 6



γυάλινες φιάλες λαδιού  
glass oil bottles

00.70120 «Olivia», 22 cl  
8,5 cm | 11,5 cm  
pack: 12

00.35040 «Helios», 24 cl  
7,8 cm | 15,2 cm  
pack: 12



anchor

90.00101 «Cruet»  
γυάλινη φιάλη λαδιού |  
oil bottle  
22 cl  
16,5 cm | 21,5 cm  
pack: 6



Borghese

01.85131 «Indro»  
γυάλινη φιάλη  
λαδιού/ξυδιού  
oil/vinegar bottle  
3,7 cm | 8 cm  
pack: 24



HENDI

30.42239  
σετ 3 τμχ. πόματα  
ροής  
free-flow pourer set of 3 pcs  
pack: 1



KitchenCraft

γυάλινες φιάλες λαδιού  
glass oil bottles

35.00381 κωνικό | conical, 20 cl  
pack: 1

35.00382 στρογγυλό | round, 45 cl  
pack: 1

35.00383 φαρδύ | wide, 40 cl  
pack: 1



Lep. Bianchi





08.00389 φιάλη λαδιού | oil bottle  
«Optima Olive Oil»  
25 cl  
pack: 1

08.00396 φιάλη ξυδιού | vinegar  
«Optima Vinegar»  
25 cl  
pack: 1





δοχεία οργάνωσης | *table caddy*

 <p><b>HENDI</b></p>	<p>30.41693 δοχείο οργάνωσης ξύλινο με 2 θέσεις <i>table caddy, wooden, with 2 compartments</i> 19x16 cm   20 cm pack: 1</p>
 <p><b>HENDI</b></p>	<p>30.41694 δοχείο οργάνωσης ξύλινο με μαυροπίνακα και 4 θέσεις <i>wooden menu and cutlery box with integrated blackboard on two sides and 4 compartments</i> 21x15 cm   15 cm pack: 1</p>
 <p><b>HENDI</b></p>	<p>30.41928 δοχείο οργάνωσης μεταλλικό ματ με ξύλινη λαβή <i>mettal table caddy, black matt, fitted with wooden handle</i> 17x13 cm   16 cm pack: 1</p>
 <p><b>HENDI</b></p>	<p>30.41918 δοχείο οργάνωσης μεταλλικό ματ με ξύλινη λαβή <i>mettal table caddy, black matt, fitted with wooden handle</i> 23x10 cm   24 cm pack: 1</p>
 <p><b>HENDI</b></p>	<p>30.41929 δοχείο οργάνωσης μεταλλικό ματ με ξύλινη λαβή <i>mettal table caddy, black matt, fitted with wooden handle</i> 14x10,5 cm   19 cm pack: 1</p>

επιτραπέζια δοχεία | *tabletop containers*

 <p><b>APS</b></p>	<p>27.00018 επιτραπέζιο δοχείο μαχαιροπίρουνων, τσιμεντένιο <i>cutlery bin, cement</i> 11 cm   14 cm pack: 1</p>
 <p><b>APS</b></p>	<p>επιτραπέζιο δοχείο, SAN/chrome απορριμμάτων/μαχαιροπίρουνων <i>table waste bin / cutlery bin SAN with chrome plated ring</i> 27.00025 λευκό   <i>white</i> 13 cm   15 cm pack: 1 27.00026 μαύρο   <i>black</i> 13 cm   15 cm pack: 1</p>
 <p><b>APS</b></p>	<p>επιτραπέζια inox δοχεία μαχαιροπίρουρων <i>inox cutlery baskets</i> *27.11921 10 cm   10 cm pack: 1 *27.11922 12 cm   13,5 cm pack: 1</p>
 <p><b>APS</b></p>	<p>*27.00031 επιτραπέζιο δοχείο απορριμμάτων, SAN <i>table garbage bin, SAN</i> 12 cm   18 cm pack: 1</p>
 <p><b>APS</b></p>	<p>*27.02038 επιτραπέζιο δοχείο απορριμμάτων, PP <i>table garbage bin, PP</i> 11 cm   14 cm pack: 1</p>

ψιχουλοσυλλέκτες | *crumble collector*

 <p><b>APS</b></p>	<p>*27.00058 ψιχουλοσυλλέκτης inox, 22x6,5 cm <i>crumble collector</i> pack: 1</p>	 <p><b>KitchenCraft</b></p>	<p>35.02606 ψιχουλοσυλλέκτης βούρτσα με φαράσι <i>tabletop dustpan and brush</i> 15 cm pack: 1</p>
 <p><b>APS</b></p>	<p>*27.00581 ψιχουλοσυλλέκτης inox, 19x4,5 cm <i>crumble collector</i> pack: 1</p>	 <p><b>HEPP</b></p>	<p>*30.10174 ψιχουλοσυλλέκτης inox, 23 cm <i>crumble scraper</i> 12.2154.0000 pack: 1</p>

επιτραπέζια είδη | *tabletop items*

αξεσουάρ σερβιρίσματος | *serving accessories*



**APS**

\*27.11781 θήκη για χαρτοπετοές τοιμεντένια  
*napkin holder; cement*  
16x7,5 cm | 10 cm  
pack: 1



**APS**

\*27.11648 θήκη για χαρτοπετοές (με 2 θέσεις 6,5 cm) τοιμεντένια,  
*napkin holder; cement*  
(2 holes each 6.5 cm)  
23,5x16 cm | 6,5 cm  
pack: 1



bor**bistro**

30.71337 χαρτοπετοεοθήκη μεταλλική  
*metall napkin holder*  
14x5 cm | 10 cm  
pack: 1



ΠΥΡΡΙΝΟΧ

19.50558 μεταλλική | *metallic*  
11,5 cm | 8,5 cm  
pack: 1



**HENDI**

θήκη για χαρτοπετοές, μαύρες  
*napkin holder; black*

30.41963 15,5x16 cm  
pack: 1

30.41965 20,5x21 cm  
pack: 1



**HENDI**

30.40270 μεταλλική, για 50 χαρτοπετοές  
*metallic for 50 napkins*  
19x19 cm | 6,5 cm  
συσκ.: 1



**HENDI**

30.40252 θήκη για χαρτοπετοές inox  
*napkin holder; inox*  
17x3 cm | 7 cm  
pack: 1



\*27.04015 ανθοδοχείο, nickel  
*flower vase*  
16,5 cm  
pack: 1



**APS**

\*27.04017 ανθοδοχείο, nickel  
*flower vase*  
18 cm  
pack: 1



**HENDI**

σαλτσιέρα, inox | *gravy boat; inox*

30.41793 8 cl (12x7,2 cm | 5 cm)  
pack: 1

30.41968 14 cl (13,5x7,6 cm | 7 cm)  
pack: 1

30.41969 23 cl (16x9,8 cm | 9 cm)  
pack: 1

30.41970 28 cl (20x10 cm | 10x5 cm)  
pack: 1

30.41975 46 cl (24x12 cm | 12 cm)  
pack: 1



**anchor**

90.64191 σαλτσιέρα, πυρίμαχη  
*sauce pot; 325 ml*  
7,9 cm | 10 cm  
pack: 1



**GÜRAL PORSELEN**  
The Excellence in Porcelain

52.84013 σαλτσιέρα πορσελάνης  
*porcelain sauce pot*  
9 cl  
pack: 1



ΠΥΡΡΙΝΟΧ

\*19.24000 τυριέρα, inox, με κουτάλι  
*cheese bowl with cheese spoon*  
11,6 cm | 6,8 cm  
pack: 1

01.44022 ανταλλακτικό τυριέρας  
*spare part*  
pack: 48



60.39609 τυριέρα, inox | *cheese bowl; inox*  
pack: 1



**APS**

\*27.40415 σετ 2 μουσταρδιέρες, γυάλινες-inox καπάκι  
*mustard glass; 2 pcs.set*  
5 cm | 6 cm  
pack: 1



35.00525 κουτάλι μελιού ξύλινο  
*wooden honey dipper*  
pack: 1

Kitchen**Craft**



\*27.01019 κουτάλι μελιού από ξύλο ελιάς 15 cm  
*olive wood honey spoon*  
15 cm  
pack: 1

**APS**



10.40330 κουτάλι μελιού πλαστικό  
*honey dipper; 15 cm*  
pack: 1

**GHIDINI ITALY**

stand αριθμών | sign holders



APS

σετ 4 stand τραπέζιου  
5 cm | 15,5 cm  
set of 4 table stand (5 cm | 15,5 cm)

\*27.71510 stainless steel  
5 cm | 10,5 cm  
pack: 1



ΝΕΟ  
προϊόν

\*27.71512 gunmetal  
5 cm | 10,5 cm  
pack: 1



ΝΕΟ  
προϊόν

\*27.71511 copper  
5 cm | 10,5 cm  
pack: 1



APS

σετ 2 σταντ αριθμών, ξύλινα,  
με 15 λευκές και 15 μαύρες κάρτες  
set 2 table stand,  
include 15 white and 15 black cards

\*27.71487 ξύλο φυσικό  
natural wood  
4x2,5 cm | 10 cm  
pack: 1



\*27.71489 μαύρα σταντ | black stands  
4x2,5 cm | 10 cm  
pack: 1



APS

εύκαμπτο stand αριθμών σπирάλ  
με 2 κλιπς, inox,  
sign holder, bedable metal coil, two metal  
clip open

27.71470 12 cm  
pack: 1

\*27.71471 23 cm  
pack: 1



APS

σετ 4 μαρμάρινα stand τραπέζιου  
table stand, marble, set of 4

\*27.71426 λευκό | white  
3,5x3,5 cm | 10 cm  
pack: 1

\*27.71428 γκρι | grey  
3,5x3,5 cm | 10 cm  
pack: 1



HENDI

stand αριθμών τραπέζιου ανοξείδωτο  
menu card table stand

30.41007 7,5 cm | 10 cm  
pack: 1

30.41008 7,5 cm | 20 cm  
pack: 1



HENDI

stand για ταμπελάκια ανοξείδωτο  
με συνδετήρα (σετ 2 τμχ.)  
tab grabber with clamp (set of 2)

30.40327 4 cm | 10,4 cm  
pack: 1

κηροπήγια | wind lights



APS

αντιανεμικό κηροπήγιο για ρεσό,  
τοιμέντο/γυαλί  
wind lightset, cement/glass

\*27.03038 6 cm | 8 cm  
σετ 2 τμχ. | set 2 pcs.  
pack: 1

\*27.03039 6 cm | 13 cm  
pack: 1

HEPP



\*30.10173 αντιανεμικό κηροπήγιο  
για ρεσό, inox/γυαλί  
wind light, metal/glass  
9,9 cm | 10,1 cm  
pack: 1











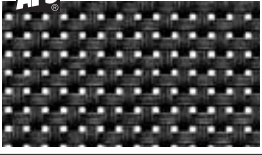

GHIDINI

10.40058 αναπτήρας αντιανεμικός  
gas lighter  
26 cm  
pack: 6/48

APS

σουπλά PVC *placemats*

	27.60012 black 45x33 cm pack: 6		*27.60018 candyred 45x33 cm pack: 6
	*27.60015 silvergrey 45x33 cm pack: 6		*27.60542 red 45x33 cm pack: 6
	27.60019 beige-brown 45x33 cm pack: 6		27.60038 beige/brown 45x33 cm pack: 6
	27.60524 platinum 45x33 cm pack: 6		27.60040 blue 45x33 cm pack: 6
	*27.60510 lines 45x33 cm pack: 6		*27.60503 beige 45x33 cm pack: 6
	*27.60511 beige 45x33 cm pack: 6		*27.60527 silver 45x33 cm pack: 6
	27.60512 black-grey 45x33 cm pack: 6		*27.60002 light blue 45x33 cm pack: 6
	*27.60540 «frames» grey, 33x45 cm pack: 6		*27.60042 blue 45x33 cm pack: 6

APS

σουπλά δερματίνης | *leatherette placemats*

	*27.60044 grey 45x32,5 cm pack: 6
	*27.60045 brown 45x32,5 cm pack: 6
	*27.60046 black 45x32,5 cm pack: 6

APS

σουπλά PVC *placemats*

	*27.60525 λευκό   white 45x33 cm pack: 6
	*27.60528 πράσινο   green 45x33 cm pack: 6
	*27.60014 μπεζ   beige 45x33 cm pack: 6

ψωμιές | bread baskets



ψωμιές, inox | *inox bread baskets*

\*27.30276 16 cm | 5 cm  
pack: 1

\*27.30277 20 cm | 5,5 cm  
pack: 1



ψωμιές, inox | *inox bread baskets*

\*27.40189 20x13,5 cm | 5,5 cm  
pack: 1

\*27.40190 24x16,5 cm | 7 cm  
pack: 1



ψωμιές στοιβαζόμενες, inox  
*inox stackable bread baskets*

27.30310 18 cm | 7,5 cm  
pack: 1

\*27.30320 23 cm | 9 cm  
pack: 1



ψωμιέρα inox 18/8 | *bread basket*

\*27.30210 20x15 cm | 7 cm  
pack: 1

27.30240 24x19 cm | 8,5 cm  
pack: 1

\*27.30250 28x21 cm | 9,5 cm  
pack: 1

ψωμιές | bread baskets



ψωμιές μεταλλικές «Deco»  
*wire bread baskets «Deco»*

30.41718 23x15 cm | 8 cm  
pack: 1



30.41779 25 cm | 8 cm  
pack: 1



30.41714 25,5x16 cm | 8 cm  
pack: 1



30.41780 38,5x16 cm | 8 cm  
pack: 1



για καλάθια ψωμιού  
ανατρέξτε

σελίδα **242-245**  
BUFFET - SERVICE

ψωμιές | bread baskets



ψωμιές μεταλλικές στρογγυλές  
*mettal bread baskets, round*

\*27.30420 17 cm | 8 cm  
pack: 1



\*27.30421 20 cm | 8 cm  
pack: 1



ψωμιές μεταλλικές οβάλ  
*mettal bread baskets, oval*

\*27.30422 20x15 cm | 8 cm  
pack: 1



\*27.30423 24x19 cm | 8 cm  
pack: 1

ψωμιές | bread baskets



ψωμιέρα μεταλλική λοξή  
*mettal bread baskets, angled*

30.41957 15 cm | 8 cm  
pack: 1



ψωμιέρες PP | bread baskets PP



**APS**

ψωμιέρες ορθογώνιες polypropylene  
rectangular polypropylene bread baskets  
19x13 cm | 6 cm

\*27.50628 μπεζ | beige  
pack: 1

\*27.50629 καφέ | brown  
pack: 1

\*27.50630 μαύρη | black  
pack: 1

\*27.50631 mokka  
pack: 1



**APS**

ψωμιέρες ορθογώνιες polypropylene  
rectangular polypropylene bread baskets  
17x11 cm | 9 cm

\*27.50632 μπεζ | beige  
pack: 1

\*27.50633 καφέ | brown  
pack: 1

\*27.50634 μαύρη | black  
pack: 1

\*27.50635 mokka  
pack: 1



**APS**

ψωμιέρες στρογγυλές rattan  
round rattan bread baskets

\*27.50600 μπεζ | beige  
16 cm | 8 cm  
pack: 1

\*27.50602 μαύρη | black  
16 cm | 8 cm  
pack: 1

\*27.50605 μπεζ | beige  
20 cm | 8 cm  
pack: 1

\*27.50607 μαύρη | black  
20 cm | 8 cm  
pack: 1

ψωμιέρες | bread baskets



**HENDI**

ψωμιέρες PP οβάλ, γκρι ανοιχτό  
bakery basket PP oval, light grey

30.41831 19x12 cm | 6 cm  
pack: 1

30.41807 25x19 cm | 6,5 cm  
pack: 1

30.41817 32x23 cm | 7 cm  
pack: 1



ψωμιέρα PP παραλ/μη, γκρι ανοιχτό  
bakery basket PP rectangle, light grey

30.41848 19x13 cm | 6 cm  
pack: 1



ψωμιέρες PP οβάλ, μαύρες  
bakery basket PP oval, black

30.41847 19x12 cm | 6 cm  
pack: 1



30.41816 25x19 cm | 6,5 cm  
pack: 1

30.41818 32x23 cm | 7 cm  
pack: 1



ψωμιέρα PP παραλ/μη, μαύρη  
bakery basket PP rectangle, black

30.41852 19x13 cm | 6 cm  
pack: 1

ψωμιέρες PP | bread baskets PP



**APS**

ψωμιέρες στρογγυλές polypropylene  
round polypropylene bread baskets

\*27.50620 μπεζ | beige  
13 cm | 10 cm  
pack: 1

\*27.50621 καφέ | brown  
13 cm | 10 cm  
pack: 1

\*27.50622 μαύρη | black  
13 cm | 10 cm  
pack: 1

\*27.50623 mokka  
13 cm | 10 cm  
pack: 1



**APS**

ψωμιέρες οβάλ polypropylene  
oval polypropylene bread baskets  
19x12 cm | 6 cm

\*27.50624 μπεζ | beige  
pack: 1

\*27.50625 καφέ | brown  
pack: 1

\*27.50626 μαύρη | black  
pack: 1

\*27.50627 mokka  
19x12 cm | 6 cm  
pack: 1

ψωμιές χάρτινες | *paper bread baskets*



ψωμιές χάρτινες οβάλ  
*oval paper bags*

\*27.30447 μαύρη | *black*  
30x20 cm | 18 cm  
pack: 1

\*27.30444 μπεζ | *beige*  
30x20 cm | 18 cm  
pack: 1



ψωμιές χάρτινες | *paper bread baskets*



ψωμιές από χαρτί kraft  
που πλένεται  
*paper bread bags,*  
*made of food grade washable kraft paper*

30.41230 μπεζ | *beige*  
17 cm | 15 cm  
pack: 1

30.41229 μαύρη | *black*  
17 cm | 15 cm  
pack: 1



ψωμιές χάρτινες στρογγυλές  
*round paper bags*

\*27.30451 μαύρη | *black*  
20 cm | 13 cm  
pack: 1

\*27.30450 μπεζ | *beige*  
20 cm | 13 cm  
pack: 1

\*27.30445 μαύρη | *black*  
24 cm | 24 cm  
pack: 1

\*27.30442 μπεζ | *beige*  
24 cm | 24 cm  
pack: 1

\*27.30446 μαύρη | *black*  
30 cm | 22 cm  
pack: 1

ψωμιές βαμβακερές πλένομενες  
*cotton bread baskets, washable*



ψωμιές στρογγυλές, μπεζ  
*round bread baskets, beige*

30.41285 15 cm | 15 cm  
pack: 1

30.41287 20 cm | 20 cm  
pack: 1

30.41116 25 cm | 16 cm  
pack: 1



πλένονται στο πλυντήριο  
ψωμιές στρογγυλές, μπλε σκούρες  
*round bread baskets, dark blue*

30.41286 15 cm | 15 cm  
pack: 1

30.41288 20 cm | 20 cm  
pack: 1

30.41117 25 cm | 16 cm  
pack: 1





ψωμιέρες | bread baskets



ψωμιέρες υφασμάτινες  
textile bread baskets

\*27.30345 στρογγυλή | round  
17 cm | 11,5 cm  
pack: 1

\*27.30346 στρογγυλή | round  
20 cm | 13,5 cm  
pack: 1

\*27.30347 ορθογώνια | rectangular  
19x11 cm | 10,5 cm  
pack: 1

\*27.30348 ορθογώνια | rectangular  
24x16 cm | 10,5 cm  
pack: 1



ψωμιέρες βαμβακερές πλενόμενες | cotton bread baskets, washable



ψωμιέρες βαμβακερές στρογγυλές  
round cotton bread baskets, washable

27.30340 μπεζ | beige  
17 cm | 8 cm  
pack: 1

27.30350 μπεζ | beige  
20 cm | 9 cm  
pack: 1

27.30351 μαύρη | black  
20 cm | 9 cm  
pack: 1



ψωμιέρες | bread baskets

ψωμιέρες με πέτρινη βάση  
baskets bread basket with stones pillow

27.30380 μπεζ | beige  
20 cm | 23,5 cm  
pack: 1

27.30390 μπεζ/καφέ | beige/brown  
20 cm | 23,5 cm  
pack: 1

27.30385 πέτρινη βάση |  
stones pillow  
19 cm | 1,5 cm  
pack: 1

ψωμιέρες | bread baskets



ψωμιέρες μεταλλικές  
με πάνινη πλενόμενη θήκη  
metal bakery basket with washable bag

30.41958 22 cm | 8 cm  
pack: 1



30.41959 25x16 cm | 7,5 cm  
pack: 1



30.41960 25x18 cm | 8,5 cm  
pack: 1



30.41962 19x19 cm | 10 cm  
pack: 1



## καπάκια πιάτων | dome covers



APS

\*27.35734 καπάκι καμπάνα, inox  
dome cover  
29 cm | 18 cm  
pack: 1



ΠΝΤΙΝΟΧ

καπάκια καμπάνα, inox  
dome covers  
\*19.50500 22 cm | 12 cm  
(για δίσκους | for tray 30 cm)  
pack: 1

\*19.50495 24 cm | 13 cm  
(για δίσκους | for tray 30 cm)  
pack: 1

19.50491 26 cm | 14 cm  
(για δίσκους | for tray 35 cm)  
pack: 1

\*19.50493 28 cm | 15 cm  
(για δίσκους | for tray 35 cm)  
pack: 1

διατίθενται και οβάλ  
32 & 42 cm  
για δίσκους 36 & 47 αντίστοιχα  
also available in oval shape  
for trays 26 & 47 respectively



ΠΝΤΙΝΟΧ

δίσκος στρογγυλός | round tray

\*19.50494 30 cm  
pack: 10

\*19.50496 35 cm  
pack: 10



araven

καπάκια πιάτων PC  
plate covers, PC

46.00485 24 cm | 6,7 cm  
pack: 12

46.00486 26,5 cm | 6,7 cm  
pack: 12

46.00891 29 cm | 6,7 cm  
pack: 12

46.00892 31,5 cm | 6,7 cm  
pack: 12



## δίσκοι αντιολισθητικοί laminated «Μυκονος» laminated trays with non-slip surface

CAMBRO



NSF   
92.00303 MY3253E76  
δίσκος αντιολισθητικός laminated  
non-slip laminated tray, «walnut»  
32,5x53 cm  
pack: 24



92.00304 MY3646E73  
δίσκος αντιολισθητικός laminated  
non-slip laminated tray, «mahogany»  
36x46 cm  
pack: 24



92.00305 MY3800E76  
δίσκος αντιολισθητικός laminated  
non-slip laminated tray, «walnut»  
38 cm  
pack: 24



## δίσκοι laminated με λεία επιφάνεια «Capri» laminated trays with smooth surface



NSF   
92.00306 CA3253E75  
δίσκος laminated  
laminated tray, «birch»  
32,5x53 cm  
pack: 24



92.00308 CA3753E76  
δίσκος laminated  
laminated tray, «walnut»  
32,5x53 cm  
pack: 24



92.00307 CA3646E82  
δίσκος laminated  
laminated tray, «granite»  
36x46 cm  
pack: 24

## δίσκοι «Versa» tray



92.00309 VE3253A29  
δίσκος ορθογώνιος «Versa», γκρι  
tray grey  
32,5x53 cm  
pack: 24





## «CamTread»

**CAMBRO**

Ένα βιομηχανικό πρότυπο για τις επιχειρήσεις εστίασης (ξενοδοχεία, εστιατόρια, μπαρ και καφέ). Η ανιποδισθητική τους επιφάνεια σταθεροποιεί ποτήρια και πιάτα ώστε να παραμένουν στη θέση τους κατά το σερβίρισμα. Κατασκευασμένοι από βαρύ ανθεκτικό fiberglass με παχιά ανιποδισθητική επιφάνεια που δεν ξεκολλά, δεν σαπίζει και αντέχει την υπερβολικά σκληρή χρήση.

The standard for srrasseries, cafes, restaurants or dessert dervice. Designed for normal usage at canteens, banquets, restaurants, bars, and catering events. The non-slip rubber surface keeps drink and food items in place during transport.

δίσκοι fiberglass με ανιολισθητική λαστική επιφάνεια «CamTread» fiberglass trays with non-slip rubber surface



δίσκος ανιολισθητικός στρογ., μαύρος  
round non-slip tray, black



92.00357 1100CT110  
27,9 cm pack: 12

92.00351 1400CT110  
35,5 cm pack: 12

92.00352 1600CT110  
40,5 cm pack: 12

92.00353 1800CT110  
45 cm pack: 12



92.00350 2700CT110  
δίσκος ανιολισθητικός οβάλ, μαύρος  
oval non-slip tray, black,  
56x68,5 cm  
pack: 12

**CAMBRO**

δίσκοι laminated με υφή ξύλου «Madeira»  
laminated trays with texture wood surface



δίσκος μελαμίνης «light oak»  
melamine tray «light oak»



30.41642 24x35 cm  
pack: 1

92.00301 36x46cm  
pack: 1

30.41645 37x53 cm  
pack: 1

δίσκος μελαμίνης «brown oak»  
melamine tray «brown oak»



30.41643 24x35 cm  
pack: 1

92.00300 36x46cm  
pack: 1

30.41646 37x53 cm  
pack: 1

δίσκος μελαμίνης «dark oak»  
melamine tray «dark oak»



30.41644 24x35 cm  
pack: 1

30.41647 37x53 cm  
pack: 1



92.00302  
δίσκος laminated  
laminated tray, «light olive»  
36x46 cm  
pack: 24

MA3646E89



Ξύλινος δίσκος ακακίας με μεταλλικά χέρια  
*acacia wood butlers tray with stainless steel handles*

\*34.60511 BTM5544BK  
54,5x44 cm | 6 cm  
pack: 1

\*34.60512 BTM6549BK  
64x49 cm | 6 cm  
pack: 1



Ξύλινος δίσκος ακακίας, φυσικό  
*acacia wood butlers tray, natural*

34.60505 BT5342  
53,5x42,5 cm | 4,5 cm  
pack: 1

34.60506 BT6448  
64x48 cm | 4,5 cm  
pack: 1



Ξύλινος δίσκος ακακίας, μαύρος  
*acacia wood butlers tray, black*

34.60507 BT5342BK  
53,5x42,5 cm | 4,5 cm  
pack: 1

34.60508 BT6448BK  
64x48 cm | 4,5 cm  
pack: 1



Ξύλινος δίσκος ακακίας, λευκός  
*acacia wood butlers tray, white wash*

34.60509 BT5342W  
53,5x42,5 cm | 4,5 cm  
pack: 1

34.60510 BT6448W  
64x48 cm | 4,5 cm  
pack: 1



στάντ δίσκων | *tray stand*



30.41014 στάντ δίσκων, inox  
δέχεται δίσκους  
με minimum πλάτος 45,7 cm  
*folding tray stand, inox  
for trays wider than 45,7 cm  
45,7 cm | 79 cm  
pack: 1*

δίσκοι αντιολισθητικοί fiberglass | *non-slip trays*

	PKS	δίσκοι στρογγυλοί, μαύροι <i>round black trays</i>
	60.00045	35,5 cm pack: 1
	60.00046	40,5 cm pack: 1
	60.00047	46 cm pack: 1
		δίσκοι οβάλ, μαύροι   <i>oval black trays</i>
	60.00083	56x68,5 cm pack: 1
	60.00084	73,5x60 cm pack: 1

	PKS	δίσκοι παραλληλόγραμμοι, μαύροι <i>rectangular black trays</i>
	60.00048	27x35 cm pack: 1
	60.00049	30,5x41,5 cm pack: 1
	60.00079	35,5x46 cm pack: 1
	60.00080	38x51,5 cm pack: 1
	60.00081	40,5x56 cm pack: 1
	60.00082	45x65 cm pack: 1

δίσκοι αντιολισθητικοί fiberglass με inox στεφάνι  
*non-slip trays with inox frame*

	PKS	δίσκοι μαύροι στρογ. (inox στεφάνι) <i>round black trays (inox frame)</i>
	60.00090	35,5 cm pack: 12
	60.00091	40,6 cm pack: 12

δίσκος room service



	30.42153	δίσκος room service <i>room serve tray</i> 60,3x40,3 cm pack: 1
--	----------	--

δίσκοι fast food | *fast food trays*

	HENDI	δίσκοι fast-food οβάλ, PP <i>oval fast food trays</i> 26,5x19,5 cm
	30.41554	γκρι   <i>grey</i>
	30.41555	μαύρος   <i>black</i>



δίσκοι fast food | *fast food trays*

		δίσκοι fast-food, PP   <i>fast food trays</i> 26,5x34,5 cm	
	30.41294	μαύρος   <i>black</i>	
	30.41290	γκρι   <i>grey</i>	
	30.41291	κόκκινος   <i>red</i>	
	30.41292	μπλε   <i>blue</i>	
	30.41293	καφέ   <i>brown</i>	
			δίσκοι fast-food, PP   <i>fast food trays</i> 30,5x41,5 cm
		30.40260	μαύρος   <i>black</i>
		30.41017	γκρι   <i>grey</i>
			δίσκοι fast-food, PP   <i>fast food trays</i> 35x45 cm
30.40261		μαύρος   <i>black</i>	
30.41021		γκρι   <i>grey</i>	
30.41022		κόκκινος   <i>red</i>	
30.41023		μπλε   <i>blue</i>	
	30.41024	καφέ   <i>brown</i>	

δίσκοι «Γρανίτης» | *granite form trays*

	HENDI	δίσκοι «Γρανίτης» <i>granite form trays</i> 30.40910 GN 1/1 - 53x32,5 cm pack: 1
--	-------	---



## service cart «KD»

Απαράμιδτη αντοχή και δειουργικότητα. Σχεδιασμένα για να βοηθούν από την αρχή έως το τέλος του σερβιρίσματος και όχι μόνο. Διατίθενται και πλαινά πάνελ για κάθε ράφι.

Versatile, durable and economically-priced carts. Marine rails and lightly-textured polypropylene shelves keep contents in place.

Ανθεκτικές κοιλύνες αλουμίνιου.

Sturdy aluminum uprights.

Ρόδες αξιόπιστες, σταθερές και αθόρυβες στους εδγημοίς.

Four powder coated steel swivel casters provide quiet transport and steady maneuvering.

**CAMBRO**

Κάθε ράφι δέχεται μια ποτηροθήκη και 2 bus boxes.

Each BC340KD shelf holds one full-sized dish rack or two standard bus boxes.



Ράφια με χείλος συγκρατούν τα αντικείμενα στη θέση τους.

Marine rails keep contents in place.

Ανθεκτικές και απρόσβητες σε δεκέδες επιφάνειες, καθαρίζονται εύκοδα.

Durable, stain-resistant surface is easy to clean.



**92.00614** BC331KD480  
τρόλεϊ πολλαπλών χρήσεων, αλουμίνιου, με 3 ράφια PP, γκρι  
KD service cart, aluminum, 3 PP shelves, gray  
83,5x41 cm | 96,5 cm  
pack: 1

**92.00615** BC331KD110  
τρόλεϊ πολλαπλών χρήσεων, αλουμίνιου, με 3 ράφια PP, μαύρο  
KD service cart, aluminum, 3 PP shelves, black  
83,5x41 cm | 96,5 cm  
pack: 1



**92.00619** BC340KD480  
τρόλεϊ πολλαπλών χρήσεων, αλουμίνιου, με 3 ράφια PP, γκρι  
KD service cart, aluminum, 3 PP shelves, gray  
101,5x54 cm | 95 cm  
pack: 1

**92.00618** BC340KD110  
τρόλεϊ πολλαπλών χρήσεων, αλουμίνιου, με 3 ράφια PP, μαύρο  
KD service cart, aluminum, 3 PP shelves, black  
101,5x54 cm | 95 cm  
pack: 1



**92.00616** BC331KDSH110  
θήκη μαχαιροπύρουων, μαύρη για τρόλεϊ KD  
silverware holder, black for KD carts  
33 x24 cm | 18,5 cm  
pack: 1

**92.00617** BC331KDTC110  
κάδος απορριμμάτων, μαύρος για τρόλεϊ KD  
trash container, black for KD carts  
33x24 cm | 56 cm  
pack: 1



**92.00620** BC340KDP480  
σετ 3 πλαινά πάνελ PP, γκρι για τρόλεϊ BC340KD  
service cart PP panels, set of 3, gray for use with BC340KD carts  
pack: 1



τρόλεϊ σερβιρίσματος | *serving trolleys*

τρόλεϊ σερβιρίσματος με 3 ράφια 90x55 cm  
αντοχή ραφιού 80 Kg, ρόδες ατσάλι γαλβανιζέ

SW 9x63

*serving trolley  
with 3 shelves 90x55 cm  
max. load per shelf 80 Kg  
100x65 cm | 95 cm*

**B.PRO**  
CATERING SOLUTIONS



τρόλεϊ φτιαγμένα από st. steel ανθεκτικό στη σκουριά  
και την σκληρή χρήση, συγκολλημένα ράφια

*trolleys made of corrosion resistant st. steel, welded shelves  
castors corrosion-resistant in compliance with DIN-18867-8*

**B.PRO**  
CATERING SOLUTIONS



PINTEX

τρόλεϊ «Smart» *trolley*



19.20090 «Smart»  
τρόλεϊ ποτών | *trolley bar*  
50x50 cm | 94 cm  
pack: 1



19.20091 «Smart»  
τρόλεϊ σερβιρίσματος  
*serving trolley*  
71x46 cm | 81 cm  
pack: 1



\*19.20102 «Smart» *gueridon*  
97150851 88x56 cm | 88 cm  
pack: 1

τρόλεϊ «Lotus» *trolley*

APS



τρόλεϊ  
σερβιρίσματος,  
PP/αλουμίνιο, γκρι

απόσταση ραφιών 31 cm, περιστρεφόμενες ρόδες με φρένα, ανοχή βάρους 150 kg/ράφι,  
σύνολικά αντέχει βάρος 450 kg  
*serving trolley PP /aluminium*  
*distance between selves 31 cm. -aluminium frame, wheels with brakes -maximum load per  
shelf: 150kg, total load 450kg.*

27.11945 108x50 cm | 96 cm  
pack: 1



δοχεία απορριμμάτων για τρόλεϊ  
*containers for trolley*

27.11946 42 lt (33x23 cm | 57 cm)  
pack: 1

27.11947 13 lt (33x23 cm | 17,5 cm)  
pack: 1

PINTEX

τρόλεϊ



\*19.20103 τρόλεϊ σερβιρίσματος  
*serving trolley*  
76x46 cm | 81 cm  
pack: 1



\*19.20030 *Gueridon*  
87x55 cm | 88 cm  
pack: 1



\*19.20031 τρόλεϊ σερβιρίσματος  
με ανοιγόμενο συρτάρι  
*serving trolley with drawer*  
102x45 cm | 88 cm  
pack: 1



matt: 01 gloss: 10    matt: 02 gloss: 20    matt: 03 gloss: 30    matt: 04 gloss: 40    matt: 05 gloss: 50    matt: 06 gloss: 60    matt: 07 gloss: 70

Η ιστορία της Ιταλικής εταιρείας FAAR ξεκίνησε πριν πάνω από πενήντα χρόνια, όταν ο Enrico Marchesi αποφάσισε να ανοίξει τη δική του επιχείρηση, οδηγούμενος από το πάθος, την τεχνογνωσία και την ποδοειτή εμπειρία του, στη διαχείριση και συντήρηση υδρικών. Σήμερα, οι συνδολογές σερβιρίσματος FAAR βρικόονται στα πιο ποδοειτή ξενοδοχεία και εσοπατόρια σε όλο τον κόσμο. Όλα τα προϊόντα κατασκευάζονται κατόπιν παραγγελίας, με εγχύρια παραγωγική διαδικασία και από νότιπους τεχνίτες. Συνδολογίας το παραδοσιακό με το σύγχρονο, τα προϊόντα FAAR είναι υψηλών προδιαγραφών 100% MADE IN ITALY, για εκείνους που αγαπούν το Ιταδικό Design και την Made in Italy ποιότητα. Η FAAR δεσμεύεται για τα εξαιρετικά προϊόντα της και οι σχεδιαστές της είναι πάντα έτοιμοι να καθύψουν οποιαδήποτε ανάγκη, δίνοντας εξατομικευμένες λύσεις.

The history of FAAR company started more than fifty years ago, when Mr. Enrico Marchesi decided to open his own business, driven by his sincere passion, technical capability, years of experience in slab turning and acquaintance of the materials. Today, FAAR collection are found to the most important hotels and restaurants all over the World. The products are produced with internally production process and by local artisans. Combining tradition with modern, FAAR products are high-end products, 100% MADE IN ITALY, satisfying people who loves the Italian Style and MADE IN ITALY quality. FAAR is committed to offer high-quality products and its designers are always glad to suggest personalized solutions.

### τρολεϊ «Luxor» trolley

Κλασική και διαχροική η σειρά τροδεϊ Luxor, έχει βασικό χαρακτηριστικό το ιδιαίτερο σκάδιομα της. Κατασκευασμένη από συμπαγές ξύλο/καπλαμά, προσφέρει λύσεις προσαρμοσμένες σε κάθε ανάγκη.

Classic and standard, Luxor collection main characteristic is its special sculpture. Trolley line in wood light mahogany color; offer solutions for every need.



**\*05.60005**  
 «Gueridon», mahogany light polished, συμπαγές ξύλο/καπλαμάς με συρόμενο ράφι  
*massive wood/veneer; sliding small self*  
 84x50 cm | 80 cm    pack: 1



**\*05.60006**  
 τρολεϊ σερβιρίσματος mahogany light polished συμπαγές ξύλο/καπλαμάς με συρόμενο μικρό ράφι και συρτάρι  
*serving trolley; massive wood/veneer with sliding small self & drawer*  
 100x54 cm | 90 cm    pack: 1



**\*05.60007**  
 τρολεϊ σερβιρίσματος, mahogany light polished συμπαγές ξύλο/καπλαμάς, συρόμενο μικρό ράφι και συρτάρι, επιπλέον ράφι και βιτρίνα πούρων  
*serving trolley; massive wood/veneer; sliding small self; drawer; extra self and cigar unit.*  
 100x54 cm | 116 cm    pack: 1



**\*05.60008**  
 τρολεϊ σερβιρίσματος, mahogany light polished, συμπαγές ξύλο/καπλαμάς, συρόμενο μικρό ράφι, συρτάρι, inox επιφάνεια εργασίας, εστία ECC norms και ντουλάπι φιάλης  
*serving trolley; massive wood/veneer; sliding small self; drawer; inox working surface, burner ECC norms and cabinet for gas bottle*  
 100x54 cm | 90 cm    pack: 1

Η σειρά τρόλεϊ Essential πολλαπλών χρήσεων, σε φυσικό ξύλο και με ανοξείδωτο σκελετό, συνδυάζει την ευελιξία με την απλότητα. Δυνατότητα δημιουργίας εξαιοικευμένου τρόλεϊ, με την επιλογή διαφορετικού άνω μέρους ανάλογα τη χρήση.

Essential line for multiple purposes, in natural wood with with satin finish inox, combines flexibility and simplicity. Depending on usage, select among different tops and create a unique trolley.



\*05.60001

«Gueridon»

satin finish inox, φυσικό ξύλο / natural wood

76x43 cm | 82 cm

pack: 1



\*05.60002

τρόλεϊ σερβιρίσματος, satin finish inox, φυσικό ξύλο,

με συρόμενο μικρό ράφι και συρτάρι

serving trolley, natural wood, sliding small self & drawer

100x53 cm | 84 cm

pack: 1



\*05.60003

τρόλεϊ τυριών, satin finish inox, φυσικό ξύλο, με συρόμενο μικρό ράφι και συρτάρι, δίσκο κοπής και roll-top PE καπάκι  
cheese/dessert trolley, natural wood, sliding small self, drawer, cutting board, roll-top PE cover

100x53 cm | 110 cm

pack: 1



\*05.60004

τρόλεϊ ψυχόμενου/γλυκών satin finish inox, φυσικό ξύλο με συρόμενο μικρό ράφι, συρτάρι, δίσκο κοπής, roll-top PE καπάκι και δίσκο ψυκτικών

cheese/dessert trolley, natural wood, sliding small self, drawer, cutting board, roll top PE cover, tray with cooling plate

100x53 cm | 115 cm

pack: 1



τρόλεϊ «Shine» trolley

Τα τρόλεϊ Shine σε φυσικό ξύλο και με inox λεπτομέρειες, διαθέτουν απλές και μοντέρνες γραμμές που ταιριάζουν σε όλους τους χώρους.

Trolley line Shine in natural wood with inox frame, with plain and modern lines is suitable for all kinds of spaces.

\*05.60011

τρόλεϊ σερβιρίσματος, φυσικό ξύλο με inox

συρόμενο μικρό ράφι και συρτάρι

serving trolley, natural wood with inox frame, sliding small self and drawer

86x47 cm | 86 cm

pack: 1



\*05.60012

τρόλεϊ bar, φυσικό ξύλο με inox, συρόμενο μικρό ράφι και συρτάρι

trolley bar, natural wood with inox frame, sliding small self and drawer

86x47 cm | 90 cm

pack: 1





## εργαλεία bar

<i>shakers</i> .....	332-334
<i>jiggers</i> .....	335
<i>αναδευτήρες, σουρωτήρια</i> .....	336
<i>mudlers, stirring glasses</i> .....	337
<i>σίφιες, εργαλεία ζάχαρης</i> .....	338
<i>σιφόν σόδας, δοχεία store'n pour, flair bottles</i> .....	339
<i>dash bottles, γουδιά, τρίφιες, infusion bottles</i> .....	340
<i>δοσομετριές - πώματα ροής</i> .....	341
<i>ανοιχτήρια</i> .....	342
<i>εργαλεία διακόσμησης, δαβίδες, μαχαίρια bar, δίσκοι κοπής</i> .....	343
<i>σει bar-διακόσμησης, bar caddy</i> .....	344
<i>στέγνωμα ποτηριών, bar caddy, stand μπουκαδιών, φρουτιέρες, μπολ ξηρών καρπών</i> .....	345

<i>σταχτοδοχεία</i> .....	346
---------------------------	-----

## εργαλεία πάγου

<i>δοχεία &amp; κουβαδάκια, δαβίδες, παγοθράνιστες, σέσουδες, καδούπια, δοχεία διατήρησης, μεταφορά πάγου</i> .....	347-349
---	---------

## cocktail

<i>κούπες χάρκινες, julep mugs</i> .....	350-351
<i>tiki mugs</i> .....	352-355
<i>καδαμάκια, σκεύη μιας χρήσης</i> .....	355

<i>HEPP bar-cafe</i> .....	356-357
----------------------------	---------

## σαμπανιέρες

<i>σαμπανιέρες inox / πλαστικές, wine coolers, stand για σαμπανιέρες</i> .....	358-361
--	---------

<i>wine coolers / σεβρίρισμα κρασιού</i> .....	362-363
--	---------

<i>κανάτες / καράφες / φιάδες</i> .....	364-366
---	---------

<i>ποτήρια polycarbonate</i> .....	366-369
------------------------------------	---------

## σεβρίρισμα καφέ/τσαγιού / σιφόν σαντιγί

<i>καφειέρες, τσαγιέρες, ποτήρια-φάντζα καφέ-τσαγιού, ζαχαριέρες, καφειέρες espresso, διανεμιτές, θήκες τσαγιού/ζάχαρης</i> .....	370-377
---	---------

<i>εργαλεία barista</i> .....	377-379
-------------------------------	---------



# *bar - wine - cafe*



shakers



27.93212  
shaker copper  
3 τμημάτων | 3 pcs  
70 cl (23 cm)  
pack: 1



30.71116  
shaker hammered  
3 τμημάτων, inox,  
σφουρίλατο, μαύρο ματ  
3 pcs, hammered inox  
black matt, 60 cl  
pack: 1



19.50557  
cocktail shaker  
inox  
2 τμημάτων | 2 pcs  
63 cl  
pack: 1



28.00009 00744  
shaker Parisienne  
2 τμημάτων, inox  
80 cl | 23,5 cm  
pack: 1



30.42230  
Tin Tin shaker  
copper plated  
2 τμημάτων | 2 pcs  
60/80 cl (17,4 cm)  
pack: 1



28.00030 00975  
Tin Tin shaker  
inox  
2 τμημάτων | 2 pcs  
70 cl (28 cm)  
pack: 1



96.30000  
Tin Tin shaker  
inox  
2 τμημάτων | 2 pcs  
70 cl | 28 cm  
pack: 1



28.00007 00139-D93  
Tin shaker  
μονό, inox  
84 cl (18 cm)  
pack: 1/12

28.00008 00460-POL  
Tin shaker, κοντό  
μονό, inox  
53 cl (12,5 cm)  
pack: 1/12



28.00233 00139-COP  
shaker Boston  
copper  
82 cl  
pack: 1



shaker Boston  
inox  
(χωρίς ποτήρι | without mix glass)  
28.00005 00139-SC  
80 cl (17,7 cm)  
pack: 1/12  
28.00006 00139  
82 cl (17,8 cm)  
pack: 1/12



shaker Boston  
inox/vinyl  
(χωρίς ποτήρι | without mix glass)  
28.00001 139VC-BLK  
μαύρο | black  
83 cl (18 cm)  
pack: 1/36  
28.00002 139VC-RED  
κόκκινο | red  
83 cl (18 cm)  
pack: 1/36



66.05139  
mixing glass  
47,3 cl (14,9 cm)  
pack: 24

	<p>34.60142 shaker «Vintage» 3 τμημάτων   3 pcs 50 cl pack: 1/10</p>
	<p>34.60143 jigger «Vintage» 2,5 / 5 cl (διαβαθμίσεις graduation per: 1,5 / 3,5 cl) pack: 1/10</p>
	<p>34.60141 barspoon «Vintage» 35 cm pack: 1/10</p>
	<p>34.60148 BVM400 mug «Vintage» σφυράλιτη   <i>hammered</i> 40 cl 8,5 cm   9 cm pack: 1/12</p>



34.60139  
julep strainer  
«Vintage», 18 cm  
pack: 1/10



34.60140  
strainer «Vintage»  
18 cm  
pack: 1/10

	<p>30.41569 shaker Antique copper 3 τμημάτων   3 pcs 70 cl pack: 1</p>
	<p>30.41572 jigger Antique copper 2,5 / 5 cl pack: 1</p>
	<p>30.41573 barspoon 40 cm pack: 1</p>
	<p>30.41571 julep strainer, 16,5 cm pack: 1</p>
	<p>30.41570 strainer, 15,5 cm pack: 1/10</p>



## «Gun Metal» inox

GenWare



34.60160  
shaker Boston  
«Gun Metal»  
70 cl  
pack: 1



28.00237 00975-GM  
Tin Tin shaker  
«Gun Metal»  
82 cl  
pack: 1



34.60063 BS-T35GM  
barspoon «Gun Metal»  
35 cm  
pack: 1/10



34.60061 HAW5GM  
σουρωτήρι | strainer  
«Gun Metal», 18 cm  
pack: 1/10



34.60060 JUL2GM  
julep strainer  
«Gun Metal», 18 cm  
pack: 1/10

σετ 10 καλαμάκια inox  
με βούρτσα καθαρισμού (11 τμχ)  
10 drinking straws made of stainless steel and cleaning  
brush (11 pcs.set)  
27.93384 8 mm | 21,5 cm  
pack: 1



34.60062 JIG2550GM  
jigger «Gun Metal»  
2,5 / 5 cl  
(διαβαθμίσεις  
graduation per: 1,5 / 3,5 cl  
pack: 1/12

34.60071 BGM550  
mug «Gun Metal»  
σοφυράλιτν | hammered  
55 cl  
8,5 cm | 9,8 cm  
pack: 1/12

334

## εργαλεία Copper inox



28.00026 00980  
shaker Parisienne  
copper  
2 τμημάτων | 2 pcs  
60 cl (22 cm)  
pack: 1



28.00236  
Tin Tin copper shaker  
2 τμημάτων | 2 pcs  
70 cl (28 cm)  
pack: 1



28.00027 00981  
jigger copper  
3 / 5 cl  
(διαβαθμίσεις  
graduation per: 30, 20, 15,  
10, 5, 0,25 cl  
pack: 1



28.00196 01339  
jigger, copper  
εσωτερ. διαβαθμίσεις  
internal ratings  
3 / 6 cl  
pack: 1



28.00028 00982  
σουρωτήρι | strainer  
copper  
pack: 1





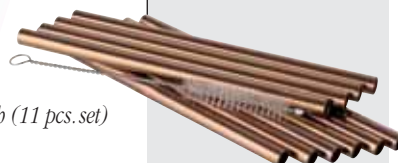

28.00029 00983  
barspoon copper  
27 cm  
pack: 1

28.00199 01342COP  
barspoon copper  
50 cm  
pack: 1

σετ 10 καλαμάκια inox copper  
με βούρτσα καθαρισμού (11 τμχ)  
10 drinking straws made of stainless steel and cleaning  
brush (11 pcs.set)  
27.93383 8 mm | 21,5 cm pack: 1



	47 RONIN 浪人	28.00047 00459	jigger Japan brushed inox, 3 / 4,5 cl 4,5-1,5 cl / 3-2-1,5-1 cl pack: 1
	APS	28.00046 00458	jigger Japan inox 2,5 / 5 cl pack: 1
	BARFLY	30.41572	jigger Antique copper 2,5 / 5 cl pack: 1
	APS	28.00226 01593	jigger, inox rubber εσωτερ. διαβαθμίσεις internal ratings: 3 / 6 cl pack: 1
	APS	28.00152 01038	jigger πλαστικό   plastic εσωτερ. διαβαθμίσεις internal ratings 2 / 4 cl pack: 1
	APS	28.00043 00104	jigger, inox, inox 2 / 4 cl pack: 1
	APS	28.00227 00102-COP	jigger, copper 2,5 / 5 cl pack: 1
	borbistro	30.71117	jigger, inox σφυρήλατο, μαύρο ματ hammered, black matt 3 / 6 cl pack: 1
	APS	28.00195 01339	jigger, inox εσωτερ. διαβαθμίσεις internal ratings: 3 / 6 cl pack: 1

	KitchenCraft	35.01205	jigger, inox, 5x7 cm (διαβαθμίσεις graduation: 1,5-2-3-4,5-6-7,5 cl pack: 1
	APS	28.00045 00374	jigger US, inox 3,5 / 5 cl (διαβάθμιση ανά graduation per 2 ml) pack: 1
	APS	28.00044 00640	jigger κυλινδρικό inox εσωτερ. διαβαθμίσεις internal ratings: 3,5 / 5 cl pack: 1
	APS	28.00040 00300	jigger πλαστικό   plastic 6 cl (διαβάθμιση ανά graduation per 1 ml) pack: 1



## σουρωτήρια | *strainers*



28.00076 julep strainer, inox  
00054  
pack: 1



28.00201 strainer, inox  
8 cm | 17 cm  
pack: 1



34.60064 strainer, inox  
18 cm  
pack: 1/10



28.00202 strainer, inox  
9x11 cm  
pack: 1



28.00073 Italian strainer  
inox  
pack: 1



19.50556 Hanthorn strainer  
inox  
τρύπες | holes: 2 mm,  
pack: 1



strainers με τέσσερα αυτιά |  
strainers with 4 prongs,  
28.00228 copper  
pack: 1  
28.00072 inox  
pack: 1



strainer βαρύ, με δύο αυτιά,  
heavy strainer with 2 prongs,  
19.50562 inox 18/10  
pack: 1



σουρωτήρι με διπλή σίατα  
strainer, double mesh, inox  
28.00074 7,6 cm  
pack: 1



σουρωτήρι κωνικό  
με διπλή σίατα, ροζ-χρυσό  
conical strainer, double mesh, inox  
60.61061 8,5 cm  
pack: 1



σουρωτήρι κωνικό με διπλή σίατα  
conical strainer, double mesh, inox  
60.61060 8 cm  
pack: 1



## αναδευτήρες | *barspoons*



28.00197 01342

barspoon extra long inox,  
50 cm  
pack: 1

27.93152

barspoon - πιρούνι | fork end  
extra long inox, 50 cm  
pack: 1

28.00198 01341

barspoon long inox,  
40 cm  
pack: 1

28.00080 00324

barspoon βαρύ οβάλ | oval  
inox, 30,5 cm  
pack: 1

28.00242 01341

barspoon inox  
30 cm  
pack: 1

28.00154 00326

barspoon Urban, inox  
με ουρά muddler | muddler end  
27,5 cm  
pack: 1

27.93134 01341

barspoon, inox  
με ουρά muddler | muddler end  
27 cm  
pack: 1

28.00079 00069

barspoon - πιρούνι | fork end  
inox, 29,5 cm  
pack: 1

28.00078 00063

barspoon με κόκκινη άκρη,  
inox, 26,5 cm  
pack: 1



60.39313 01341

barspoon, inox  
22,2 cm  
pack: 12







## stirring glasses

	<b>00.10090</b> mixing glass «Americia '20s» 75 cl 10,8 cm   16 cm pack: 6
	<b>28.00039</b> stirring glass Japanese 00722 65 cl pack: 1
	<b>40.00064</b> stirring glass «Carats» 75 cl 9,5 cm   14,9 cm pack: 6
	<b>37.42354</b> stirring glass «Flashback» 75 cl 9,3 cm   19,1 cm pack: 6
	<b>34.60067</b> stirring glass «Astor» AST500 50 cl pack: 10



	<b>28.70008</b> stirring glass 63917 κρυσταλλίνος   <i>crystalline</i> 60 cl 8,7 cm   14,8 cm pack: 1/8
	<b>28.70009</b> stirring glass «Diamond cut» 63917/27710 κρυσταλλίνος   <i>crystalline</i> 8,7 cm   14,8 cm 60 cl pack: 1/8
	<b>beaker «Diamond cut»</b> κρυσταλλίνος   <i>crystalline</i> <b>28.70010</b> 17 cl 63917/29180 pack: 6/12 <b>28.70011</b> 10 cl pack: 6/12

## muddlers

	<b>28.00149</b> muddler πλαστικό με inox κεφαλή <i>plastic, inox cap</i> 4,5 cm   25 cm pack: 1		<b>30.42235</b> muddler PP λεία κεφαλή <i>flat bead</i> 3,4 cm   20,7 cm pack: 1
	<b>28.00066</b> muddler 00643 inox με PE κεφαλή <i>inox, PE bead</i> , 21 cm pack: 1/20		<b>30.42281</b> muddler PP κεφαλή με ακίδες <i>pointed bead</i> 3,4 cm   20,7 cm pack: 1
	<b>28.00064</b> muddler 00656 πλαστικό με λεπτές μύτες <i>plastic with thin tips</i> , 24 cm pack: 1/12		<b>30.42236</b> muddler PP κεφαλή με ραβδώσεις <i>ribbed bead</i> 3,4 cm   20,7 cm pack: 1
	<b>28.00060</b> muddler 00653 πλαστικό με χοντρές μύτες <i>plastic with coarse tips</i> 21 cm pack: 1/12		<b>28.00065</b> muddler, 00095 ξύλινο λείο <i>smooth beech wood</i> 21 cm pack: 1





οτύφτες | *squeezers*

<p>HENDI</p>	<p>πρέσες αλουμινίου <i>aluminum squeezers</i></p> <p>30.41302 πορτοκαλί, για πορτοκάλια <i>orange (for oranges)</i> 23,2x9,1x6 cm pack: 1</p> <p>30.41303 κίτρινη, για λεμόνια <i>yellow (for lemons)</i> 23,2x7,5x4,5 cm pack: 1</p> <p>30.41232 πράσινη, για λάιμ <i>green (for limes)</i> 20,3x6x4 cm pack: 1</p>		<p>34.00061 λεμονοστίφτης χειρός ξύλινος, <i>wooden squeezer</i> 15 cm pack: 6/72</p>
<p>APS</p>	<p>28.00070 πρέσσα λάιμ αλουμινίου/μπλε πλαστικό 01408 pack: 1</p>		<p>60.39500 λεμονοστίφτης, inox <i>inox squeezer</i> 12/17 cm   10,5 cm pack: 1</p>
<p>APS</p>	<p>πρέσες λάιμ, διπλές από κράμα ψευδαργύρου <i>two size lime/lemon squeezers, zink alloy</i></p> <p>27.93214 μαύρη/κόκκινη <i>black/red</i> pack: 1/6</p> <p>28.00068 κίτρινη/πράσινη <i>yellow/green</i> 00704 pack: 1/6</p>	<p>APS</p>	<p>27.71430 στίφτης φέτας λεμονιού, <i>lemon slice squeezer</i> 8x7 cm pack: 1</p>
<p>APS</p>	<p>28.00128 πρέσσα λάιμ μαύρη από κράμα ψευδαργύρου <i>lime/lemon squeezer, zink alloy</i> 00705-BLK pack: 1/12</p>	<p>APS</p>	<p>28.00224 absinth spoon inox 01338 3,7 cm   16,3 cm pack: 1</p>
<p>GenWare</p>	<p>34.60065 πρέσσα βαριάς χρήσης κράμα ψευδαργύρου <i>heavy duty squeezer, zink alloy</i> «Mexican Elbow» 7,5 cm   22 cm pack: 5</p>		

σίφτες | *juicers*



**HENDI**

30.40130 επιτραπέζιος σίφτης εσπεριδοειδών, χρωμίου  
*citrus chrome-plated juicer*  
22,5x18 cm | 51 cm  
pack: 1

σιφόν σόδας | *soda siphons*



47 RONIN  
浪人

\*28.00238 σιφόν σόδας με πλαστικό δοχείο και μεταλλικό πλέγμα  
*soda siphon, plastic container and metallic grid*  
1 lt  
pack: 1



**HENDI**

30.41231 σιφόν σόδας, inox  
*soda siphon*  
1 lt, inox,  
10 cm | 32 cm  
pack: 1

δοχεία *store'n pour bottles*



**APS**

28.00100 δοχείο store'n pour PP μαύρο | *black*, 95 cl  
00031-BLK  
pack: 1



δοχεία store'n pour PP  
*store'n pour bottles*

30.40088 κόκκινο | *red*  
80 cl (30 cm)  
**HENDI**  
pack: 1



**APS**

δοχεία store'n pour PP  
*store'n pour bottles*

28.00098 κόκκινο | *red*  
00031 95 cl  
pack: 1

28.00099 κόκκινο | *red*  
000033 1,9 lt  
pack: 1

αμπούλες σιφόν | *soda chargers*



**HENDI**

αμπούλες σιφόν σόδας, περιέχουν 8 gr CO<sub>2</sub>, για ένα γέμισμα σιφόν 1 lt  
*contains 8 grams of CO<sub>2</sub>, a single filling of a 1L soda siphon*

30.40981 10 τμχ. | *10 pcs*  
pack: 1

μπουκάλια με πόμα ροής | *bottles with pourer*



*L'Espresso*

μπουκάλια γυάλινα με πόμα ροής σιλικόνης/inox  
*bottles with silicone/inox pourer*

08.00603 0,5 lt  
pack: 1/12

08.00604 0,25 lt  
pack: 1/12







flair bottle



**APS**

28.00102 flair bottle with pourer λευκό | *white*  
75 cl  
pack: 1





## dash bottles γυάλινα

	08.00600 dash bottle «Elixir» με pourer, 10 cl 5,7 cm   13,5 cm pack: 1/24
	08.00601 dash bottle «Elixir» με pourer, 10 cl 5,2 cm   14,2 cm pack: 1/24
	28.00156 dash bottle ανάγλυφο, 20 cl 00945 (χωρίς pourer   without pourer) 9 cm   10,7 cm pack: 1
	28.00037 dash bottle old fashioned, 20 cl 00934 (χωρίς pourer   without pourer) 7 cm   11,2 cm pack: 1/12
	28.00232 bitter bottle, 10 cl 01587 (χωρίς pourer   without pourer) 5,6 cm   13 cm pack: 1
	28.00157 spray dash bottle, 8 cl Martini Mister 00967 5 cm   16 cm pack: 1/12
	28.00035 pourer για dash bottles 00190 pack: 1/12



## γουδιά | mortars

	35.01073 γουδιά από γρανίτη granite mortar and pestle 12 cm   6,5 cm pack: 1
---	--

## infusion bottles













	37.92397 «Tiki dispenser» βάζο γυάλινο με βρύση με φίλτρο infusion jar, spigot with filtration system 7 lt pack: 1
	90.93474 «Isaac J. Collins» βάζο γυάλινο με βρύση infusion jar with spigot 16,5/24 cm   32 cm 5,67 lt pack: 1
	30.80408 σετ 2 βάζα γυάλινα με βρύση σε βάση set of 2 infusion jars with base 35x18 cm   38,5 cm pack: 1
	28.00203 βάζο γυάλινο με καπάκι jar with tap 10,5 cm   14,7 cm pack: 1/24

## τρίφτες μπαχαρικών | spice graters inox

	35.01075 τρίφτης μπαχαρικών nutmeg grater 13 cm pack: 1
	28.00189 τρίφτης μπαχαρικών nutmeg grater 15,5 cm pack: 1

	<p>δοσομετρικές <i>measure pourers</i></p> <p>28.00050 00057 μπλε   blue 25 ml pack: 1/12</p> <p>28.00048 00016 κίτρινο   yellow 40 ml pack: 1/12</p> <p>28.00049 00025 διάφανος   clear 50 ml pack: 1/12</p>		<p>πώματα ροής, σετ 4 τμχ. <i>free pourers, set of 4 pcs</i></p> <p>30.41561 μπλε   blue pack: 1</p> <p>30.41562 κίτρινο   yellow pack: 1</p> <p>30.41933 κόκκινο   red pack: 1</p> <p>30.41934 διάφανο   clear pack: 1</p>		<p>30.42240 σετ 6 τμχ. πώματα ροής flip top <i>slow pourer with flip top, set of 6 pcs</i> pack: 1</p>
	<p>δοσομετρικές, σετ 2 τμχ. <i>measure pourers, set of 2 pcs</i></p> <p>30.41565 20 ml pack: 1</p> <p>30.41566 35 ml pack: 1</p> <p>30.41567 40 ml pack: 1</p> <p>30.41568 50 ml pack: 1</p>		<p>28.00058 00011 πώμα ροής μεταλλικό με φίλτρο <i>metal pourer with fly-screen</i> pack: 1/12</p>		<p>30.42239 σετ 3 τμχ. πώματα ροής <i>free-flow pourer set of 3 pcs</i> pack: 1</p>
	<p>πώματα ροής <i>free pourers</i></p> <p>28.00055 00008 διάφανος   clear pack: 1/12</p> <p>28.00056 00009 κίτρινο   yellow pack: 1/12</p> <p>28.00052 00003 πράσινο   green pack: 1/12</p> <p>28.00053 00004 κόκκινο   red pack: 1/12</p>		<p>πώματα ροής μεταλλικά <i>metal pourers</i></p> <p>28.00062 00023-RED κόκκινο   red pack: 1/12</p>		<p>28.00133 00382 πώμα ροής whiskey διάφανο <i>dash bottle pouper, clear</i> pack: 1/12</p>
	<p>πώματα ροής, σετ 6 τμχ. <i>free pourers, set of 6 pcs</i></p> <p>30.41563 2 μαύρα - 2 λευκά - 2 κόκκινα <i>2 black - 2 white - 2 green</i> pack: 1</p> <p>πώματα ροής, σετ 6 τμχ. <i>free pourers, set of 6 pcs</i></p> <p>30.41564 διάφανα   clear 2 μπλε - 2 κόκκινα - 2 πράσινα <i>2 blue - 2 red - 2 green</i> pack: 1</p>		<p>28.00061 00023-GRN πράσινο   green pack: 1/12</p> <p>28.00063 00023-YEL κίτρινο   yellow pack: 1/12</p>		<p>πώματα ροής <i>metal pourers</i></p> <p>28.00230 00023-COP copper pack: 1/12</p> <p>28.00229 00023-GOL gold pack: 1/12</p> <p>28.00059 00023-SP μεταλλικό   inox <i>spill stop</i> pack: 1/12</p>
			<p>30.41557 σετ 6 πώματα ροής χρωμίου <i>regular chrome pourer</i> pack: 1</p>		<p>28.00057 00018-SMO κάλυμμα πωμάτων ροής <i>cover for pourers</i> pack: 1/12</p>
			<p>30.41558 σετ 6 πώματα ροής μεταλλικά με καπάκι <i>metal pourer with flip top set of 6 pcs</i> pack: 1</p>		<p>28.00159 0465-BLK σετ 12 καλύμματα πωμάτων ροής, μικρά <i>cover for metal pourer set of 12 pcs</i> pack: 1/12</p>
			<p>30.41559 σετ 6 πώματα ροής μεταλλικά <i>metal pourer, slow flow set of 6 pcs</i> pack: 1</p>		<p>10.40520 πώμα φιάλης σαμπάνιας <i>champagne bottle sealer</i> pack: 24/144</p>
			<p>30.41560 σετ 6 πώματα ροής μεταλλικά <i>metal pourer, fast flow set of 6 pcs</i> pack: 1</p>		<p>10.40515 σετ 3 τμχ. πώματα φιάλης <i>bottle sealer, set of 3 pcs</i> pack: 12/72</p>
					<p>30.42225 σετ 3 τμχ. πώματα φιάλης (λευκό, πράσινο, κόκκινο) <i>bottle sealer, set of 3 pcs green, red, white</i> pack: 1</p>

ανοιχτήρια | *openers*

 <p>GenWare</p>	<p>34.60068 ανοιχτήρι, copper 277-01C <i>copper bar blade</i> pack: 12</p>	 <p>GHIDINI ITALY</p>	<p>10.40283 ανοιχτήρι «No 3003» <i>wing corkscrew</i> pack: 1/12</p>
 <p>APS</p>	<p>28.00113 ανοιχτήρι inox/βινυλίου 00099-BLK <i>black inox/vinyl bar blade</i> pack: 1</p>		<p>10.40003 ανοιχτήρι «No 1» <i>crome wing corkscrew</i> pack: 1/36</p>
 <p>HENDI</p>	<p>30.41606 ανοιχτήρι   <i>bar blade</i> inox 17,9x4 cm pack: 1</p>		<p>10.40201 ανοιχτήρι «No 4» <i>crome wing corkscrew</i> pack: 12/72</p>
 <p>APS</p>	<p>27.93302 ανοιχτήρι <i>waiter's corkscrew</i> 11,5 cm pack: 1</p>		<p>10.40217 ανοιχτήρι βαρέως τύπου «No 20» <i>crome wing corkscrew</i> pack: 1</p>
 <p>GHIDINI ITALY</p>	<p>10.40282 ανοιχτήρι «No 3007» <i>waiter's corkscrew</i> pack: 1/24</p>	 <p>GHIDINI ITALY</p>	<p>10.40205 ανοιχτήρι <i>can opener</i> pack: 12/72</p>
 <p>GHIDINI ITALY</p>	<p>10.40225 ανοιχτήρι «No 50» <i>waiter's corkscrew</i> pack: 1</p>	 <p>GHIDINI ITALY</p>	<p>10.40208 ανοιχτήρι «No 25» <i>waiter's corkscrew</i> pack: 24/288</p>
 <p>GHIDINI ITALY</p>	<p>10.40014 ανοιχτήρι 2 θέσεων <i>waiter's corkscrew</i> pack: 12/72</p>	 <p>GHIDINI ITALY</p>	<p>10.40020 ανοιχτήρι «No 131» <i>bottle/cap opener</i> pack: 12/72</p>
 <p>GHIDINI ITALY</p>	<p>10.40224 ανοιχτήρι «No 363» <i>waiter's corkscrew</i> pack: 1</p>	 <p>GHIDINI ITALY</p>	<p>10.40203 ανοιχτήρι «No 16» <i>corkscrew</i> pack: 12/144</p>
	<p>30.40080 ανοιχτήρι <i>waiter's corkscrew</i> pack: 1</p>	 <p>HENDI</p>	<p>30.42233 επιπόχιο ανοιχτήρι <i>wall bottle opener</i> 10,5x5 cm   2,5 cm pack: 1</p>
 <p>HENDI</p>	<p>30.40896 ανοιχτήρι με μεταλλική λαβή, 3 λειτουργίες <i>waiter's corkscrew, with metal handle, 3 functions.</i> pack: 1</p>	 <p>APS</p>	<p>27.93124 επιπόχιο ανοιχτήρι <i>wall bottle opener</i> 7x8 cm pack: 12/72</p>

( για δεξιόχειρες ) εργαλεία διακόσμησης



APS

27.88834 αποφλοιωτής  
swivel peeler  
17 cm  
pack: 1



27.88823 zester  
14,5 cm (0,2+0,5 cm)  
pack: 1



30.41332 κουτάλι με δόντια  
22x15,5 cm  
pack: 1



30.41333 φόρμα οβάλ  
melon baller oval  
16,5 cm (2,6 cm)  
pack: 1



27.88827 ξεφλουδίσματος  
peeler  
17 cm  
pack: 1



27.88810 φόρμα κροκέτας διπλή  
double melon baller  
16,5 cm (2,2 / 2,5 cm)  
pack: 1



27.88850 ξεφλουδίσματος  
swivel peeler  
16,5 cm  
pack: 1



27.88811 φόρμα κροκέτας διπλή  
double melon baller  
17 cm (2,2 / 3 cm)  
pack: 1



27.88843 μαχαίρι διακόσμησης  
decoration knife  
19 cm  
pack: 1



27.88836 μηλοκαθαριστής  
apple corer  
21 cm (2,2 cm)  
pack: 1



27.88846 μαχαίρι μπαρ  
bar knife  
21 cm  
pack: 1



30.42019 μαχαίρι grapefruit  
grapefruit knife  
21,5 cm  
pack: 1



30.40908 σετ 6 εργαλείων σε θήκη  
decoration toolset - 6 pieces  
pack: 1



30.42009 πορτοκαλοκαθαριστής  
orange peeler  
18 cm  
pack: 1



27.88826 εργαλείο διακόσμησης  
decorating knife  
15 cm  
pack: 1



35.01527 καθαριστής και κόπτης  
ανανά  
pineapple peeler and slicer  
pack: 6

KitchenCraft

## οργάνωση bar



σετ bar, μαύρο με PP καπάκι και PP θήκες  
*condiment holder, black transparent ABS lid with PP storage containers*

48x15 cm | 10 cm

30.42222 3 θέσεων | 3 containers  
pack: 1

30.42223 4 θέσεων | 4 containers  
συσκ.: 1

30.41306 5 θέσεων | 5 containers  
συσκ.: 1

30.42224 6 θέσεων | 6 containers  
pack: 1



σετ bar, inox με PP καπάκι  
*condiment holder, st. steel transparent PP lid with PP storage containers.*

30.40085 5 θέσεων | 5 inserts  
37,5x14 cm | 9 cm  
συσκ.: 1



30.41305 σετ διακόσμησης ABS για αλάτι και ζάχαρη  
*3-tier glass rimmer, for salt and sugar, black*  
20x16 cm | 7,5 cm  
pack: 1



30.41297 bar caddy, μαύρο | black  
24x14,5 cm | 10,5 cm  
pack: 1



34.60069 γαλβανιζέ θήκη για bar caddy 30.41297  
*galvanized container for bar caddy 30.41297*  
24,5x15,5 cm | 12,5 cm  
pack: 12



30.41576 bar caddy, inox με 6 θήκες  
*with 6 chambers*  
24,5x16,7 cm | 13,2 cm  
pack: 1



28.00116 bar caddy χρωμίου | chrome  
14,3x19,3 cm | 13,7 cm  
pack: 1



30.42234 θήκη 3 τμημάτων για καρτοπετοσέτες, καλαμάκια, αναδευτήρες  
*napkin holder with 3 compartments, PS black*  
19,3x14,3 cm | 13,6 cm  
pack: 1



θήκη για καλαμάκια, inox  
*cutlery/straw stand*  
60.84007 3 θέσεων  
pack: 1

## μαχαίρια bar | bar knives

28.00147 μαχαίρι κεραμικό pro bar γενικής χρήσης  
*ceramic, pro bar knife, 10,2 cm*  
00937  
pack: 1/6



30.41937 ίσιο μαύρο | straight, black, 7,5 cm  
pack: 1



30.41049 κουζίνας μαύρο | paring black, 8,7 cm  
pack: 1



30.40966 καμπύλωτο μαύρο | curved black, 6 cm  
pack: 1



30.40296 ντομάτας μαύρο | tomato black, 11 cm  
pack: 1



## λαβίδες διακόσμησης | tweezers



λαβίδες st. steel,  
*multipurpose st. steel tweezers*

30.41180 16 cm  
pack: 1

30.41179 21,5 cm  
pack: 1

30.41178 23 cm  
pack: 1

30.40143 30 cm  
pack: 1

30.42000 μαύρη | black, 30 cm  
pack: 1



47.34807 λαβίδα | tweezers, 25 cm  
pack: 1

## δίσκοι κοπής | cutting boards









28.00081 δίσκος κοπής μαύρος αντιολισθητικός  
*anti-slip black cutting board*  
00855  
35x23,6 cm | 1,2 cm  
pack: 1

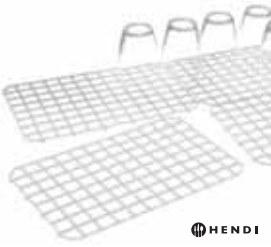

30.41411 δίσκος κοπής GN 1/2 μαύρος, με αυλάκι  
*black cutting board GN 1/2 with groove*  
26,5x32,5 cm | 1,2 cm  
pack: 1



## οργάνωση bar

	30.41307 bar mat, μαύρο   <i>black</i> 61x8,5 cm   1,5 cm pack: 1
	bar mat μαύρο   <i>bar mat black</i> 30.41575 30x15 cm   0,9 cm pack: 1 30.42114 45,5x30,5 cm   1 cm pack: 1
	28.00110 drip mat μαύρο   <i>black</i> 30,5x30,5 cm pack: 1
	30.40086 βάση στραγγίσματος, PP συνδεόμενα φύλλα <i>drainage mat, PP, connectable</i> 31,3x20,9 cm pack: 1
	speed racks 28.00105 6 μπουκαλιών   <i>6 bottles</i> 56x10,5 cm   15,5 cm pack: 1 28.00106 8 μπουκαλιών   <i>8 bottles</i> 81x10,5 cm   15,5 cm pack: 1
	28.00169 glass holder 41 cm pack: 1
	30.80016 stand πορτοκαλιών <i>stand for oranges</i> 32x32 cm   27 cm pack: 1
	30.80027 stand πορτοκαλιών <i>stand for oranges</i> 12x35 cm   41 cm pack: 1

## μπολάκια ξηρών καρπών | *snack bowls*

	μπολ διπλού τοιχώματος, inox <i>double-wall bowls</i> 34.60144 26 cl, 11,5 cm   5 cm pack: 1 34.60145 40 cl, 13 cm   5,4 cm pack: 1
	γυάλινα μπολ «Practica» <i>glass bowls</i> 01.44102 10 cm (15 cl) pack: 6/36 01.44103 12 cm (25 cl) pack: 6/36 01.44104 14 cm (38 cl) pack: 6/24
	γυάλινα μπολ «Modi» <i>glass bowls</i> 01.44056 8x8 cm (17 cl) pack: 36 01.44017 10,5x10,5 cm (27 cl) pack: 36 01.44053 14x14 cm (80 cl) pack: 12
	30.41091 σετ 6 μπολ πορσελάνης <i>porcelain bowl, set of 6</i> 8x8 cm   3,5 cm pack: 1
	60.11041 μπολ μελαμίνης μαύρο <i>melamine bowl, black</i> 9,8x8,4 cm   4,2 cm pack: 1
	μπολ μελαμίνης μαύρο <i>melamine bowl, black</i> 60.11048 8x8 cm   4 cm pack: 8 60.11045 9,3x9,3 cm 3,8 cm pack: 6 60.11046 10x10 cm   5,5 cm pack: 6 60.11047 12,1x12,1 cm   4,5 cm pack: 4
	27.83742 δίσκος λευκός   <i>tray white</i> 22,5x9,5 cm   3 cm pack: 1 27.83744 δίσκος μαύρος   <i>tray black</i> 22,5x9,5 cm   3 cm pack: 1

## χαρτοπετοστοθές | *napkin holders*

	30.40270 μεταλλική, για 50 χαρτοπετοστές <i>metallic for 50 napkins</i> 19x19 cm   6,5 cm pack: 1
	27.11765 μεταλλική, για 150 χαρτοπετοστές <i>metallic for 150 napkins</i> 19x19 cm   19 cm pack: 1



σταχτοδοχεία | ashtrays

	<p>91.00102 σταχτοδοχείο τρίγωνο <i>triangle ashtray</i> 8,6 cm pack: 24</p>		<p>27.00570 σταχτοδοχείο τοιμεντένιο <i>cement ashtray</i> 10,5 cm   5 cm pack: 1</p>
	<p>αντιανεμικά σταχτοδοχεία, γαυλί/χρόμιο <i>wind proof ashtrays, glass/crome</i> 10 cm   7 cm</p> <p>28.00161 λευκό   <i>white</i> pack: 12</p> <p>28.00162 μαύρο   <i>black</i> pack: 12</p> <p>28.00204 μπλε   <i>blue</i> pack: 12</p>		<p>30.40983 αντιανεμικό σταχτοδοχείο, χρωμίου <i>wind proof crome ashtray</i> 9 cm   4,5 cm pack: 1</p>
	<p>60.40502 σταχτοδοχείο πορσελάνης <i>porcelain ashtray</i> 10,5cm pack: 6/36</p>		<p>30.40972 σταχτοδοχείο ασφαλείας, inox <i>inox safety ashtray</i> 14 cm   3 cm pack: 1</p>
	<p>σταχτοδοχεία μελαμίνης αντιανεμικά, στοιβαζόμενα <i>melamine wind proof ashtrays, stackable</i></p> <p>27.83610 λευκό   <i>white</i> 10 cm   4 cm pack: 1</p> <p>27.83611 μαύρο   <i>black</i> 10 cm   4 cm pack: 1</p>		<p>30.40971 σετ 3 σταχτοδοχεία inox αντιανεμικά, <i>set of 3 wind proof ashtrays, inox</i> 9 cm   2,8 cm pack: 1</p>
	<p>σταχτοδοχεία μελαμίνης αντιανεμικά, στοιβαζόμενα <i>melamine wind proof ashtrays, stackable</i></p> <p>27.83613 μαύρο   <i>black</i> 12 cm   4,5 cm pack: 1</p>		<p>30.41664 σταχτοδοχείο inox μαύρο, με αφαιρούμενο χείλος <i>ashtray st. steel, matt black coating, with remoaable rim</i> 10,5 cm   5,8 cm pack: 1</p>
	<p>27.83616 σταχτοδοχείο μαύρο μελαμίνης, στοιβαζόμ. <i>melamine ashtrays, stackable</i> 9,5 cm pack: 1</p>		<p>σταχτοδοχείο inox αντιανεμικά με αφαιρούμενο χείλος <i>ashtray st. steel, wind proof, with remoaable</i></p> <p>60.60052 11 cm pack: 1</p> <p>60.60053 14,5 cm pack: 1</p>

κουβαδάκια πάγου | *ice buckets*



27.36015 «Classic», inox  
κουβαδάκι πάγου διπλού  
τοιχώματος με καπάκι  
*double wall ice bucket with lid*  
1,3 lt  
14 cm | 22 cm  
pack: 1



60.30108 κουβαδάκι πάγου διπλού  
τοιχώματος με καπάκι  
*double wall ice bucket with lid*  
1 lt  
15,5 cm | 17,5 cm  
pack: 1



60.34552 κουβαδάκι πάγου διπλού  
τοιχώματος με καπάκι  
*double wall ice bucket with lid*  
1 lt  
12,6 cm  
pack: 1



30.80006 κουβαδάκι πάγου  
ανοξείδωτο με λαβίδα  
*ice bucket with tong*  
12 cm  
pack: 1/12



01.50061 «Seekop»  
κουβαδάκι πάγου γυάλινο  
*glass ice bucket*  
12 cm | 14 cm  
pack: 6



01.50060 «Polka»  
κουβαδάκι πάγου γυάλινο  
(χωρίς λαβίδα)  
*glass ice bucket without tong*  
73 cl  
12 cm | 12 cm  
pack: 6



λαβίδες πάγου ανοιξίδωτες | *ice tongs*



34.60074 λαβίδα πάγου | *ice tong*  
copper  
17,8 cm  
pack: 12

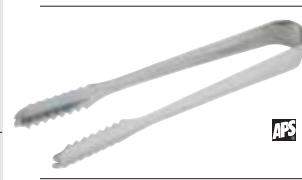

27.75805 λαβίδα πάγου | *ice tong*  
inox  
17,5 cm  
pack: 1



28.00093 λαβίδα πάγου | *ice tong*  
inox  
17 cm  
pack: 1/12

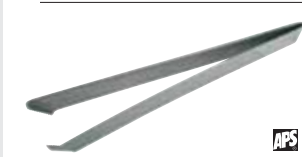

28.00094 λαβίδα πάγου | *ice tong*  
inox  
30 cm  
pack: 1



\*27.93190 λαβίδα πάγου | *ice tong*  
inox  
20 cm  
pack: 1/12



30.40263 σετ 2 λαβίδες πάγου,  
*set of 2 ice tongs*  
inox, 18 cm  
pack: 2/2



96.31002 λαβίδα πάγου | *ice tong*  
inox  
16 cm  
pack: 1

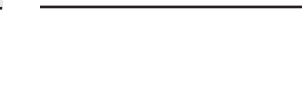

96.31001 λαβίδα πάγου | *ice tong*  
inox  
16 cm  
pack: 1

## διατήρηση πάγου | ice boxes



28.00089 δοχείο πάγου πλαστικό  
*plastic ice box*  
3,4 lt (17x17 cm | 19 cm)  
pack: 1



27.36033 δοχείο πάγου αλουμινίου  
*aluminium ice boxe*  
5 lt  
18,5 cm | 20 cm  
pack: 1



\*27.36037 δοχείο πάγου αλουμινίου  
*aluminium ice boxe*  
8 lt  
27 cm | 20 cm  
pack: 1

δοχεία πάγου, λευκά  
διπλού τοιχώματος  
*double wall white ice boxes*

30.41410 5 lt (19 cm | 20 cm)  
pack: 1

30.41578 10 lt (29,2 cm | 22 cm)  
pack: 1

## σέσουλες πάγου | ice scoops



28.00160 σέσουλα πάγου,  
διάτρητη, inox  
*perforated ice scoop, inox*  
21x6,5 cm  
pack: 12



28.00083 σέσουλα πάγου,  
διάτρητη, inox  
*perforated ice scoop, inox*  
19x5 cm  
pack: 1



30.42221 σέσουλα πάγου,  
διάτρητη, αλουμινίου  
*ice scoop slotted, aluminium*  
22x8 cm  
pack: 1



σέσουλες | *ice scoops, PC*

28.00085 μαύρη | *black*, 0,7 lt  
pack: 1/12

28.00084 κόκκινη | *red*, 0,35 lt  
pack: 1/12

28.00087 μαύρη | *black*, 0,18 lt  
pack: 1/12



αθάνατες και βολικές σέσουλες PC  
*virtually unbreakable scoops will not dent, chip or rust.*

92.00850 170 gr  
SCP6CW pack: 12

92.00851 340 gr  
SCP12CW pack: 12

92.00852 680 gr  
SCP24CW pack: 12

92.00853 1.814 gr  
SCP64CW pack: 6

## μεταφορά πάγου | cool boxes

92.00611  
τρόλεϊ μεταφοράς πάγου  
*polyethylene*, 125 lt  
με συρόμενο καπάκι,  
4 ρόδες, κάνουλα  
*insulated ice container*  
125 lt,  
*polyethylene*  
with sliding lid,  
4 wheels and tap  
58,5x80 cm | 74,5 cm  
pack: 1



**CAMBRO**

- Σώμα από πολυαιθυλένιο με επιπλέον αφρό μόνωσης παντού, σε αντίθεση με τον ανταγωνισμό, επιτυγχάνοντας την διατήρηση του πάγου για μέρες.
- Περιβλήμα ανθεκτικό και συμπαγές, δεν χάνει το σχήμα του, δεν σκίζεται, δεν σκουριάζει, δεν ξεθωριάζει, δεν σπάει.
- Με ειδικό δοχείο που συγκεντρώνει το νερό από τον πάγο που λειώνει ώστε να διατηρείται περισσότερο χρόνο ο πάγος.
- *Polyethylene body and thick foam insulation hold ice for days.*
- *Rugged, all-weather exterior will not crack, dent, bubble, chip, rust or break.*
- *Unique sliding lid slides back and under during use, reducing risk of cross-contamination.*
- *Recessed well and drain shelf keep ice out of water, extending holding times.*
- *Recessed, molded-in handles ease lifting and maneuvering.*
- *Slant top sliding lid units fit under prep/catering tables and counters.*

καλούπια πάγου | *ice molds*

	<p>30.41582 καλούπι πάγου σιλικόννης για σφαίρες 4,5 cm <i>silicone ice mold for ice spheres 4,5 cm</i> 18x12,5 cm   5 cm pack: 1</p>		<p>28.00175 «Collins» καλούπι πάγου για παγάκι 13,2x3x3 cm <i>ice mold for rectangular ice 14,5x12   3 cm</i> pack: 1</p>
	<p>30.41579 καλούπι πάγου σιλικόννης «διαμάντι» <i>silicone ice mold «diamond»</i> 19x10,5 cm   3 cm pack: 1</p>		<p>28.00095 καλούπι πάγου, για κύβους 6,3 cm <i>ice mold for ice cubes 6,3 cm</i> 14,5x14,5 cm   6,3 cm pack: 1</p>
	<p>30.41583 καλούπι πάγου σιλικόννης για 6 σφηνάκια πάγου <i>silicone ice mold for 6 ice shots</i> 12,5x19 cm   6 cm pack: 1</p>		<p>35.02607 καλούπι πάγου, για κύβους 4,5 cm <i>ice mold for ice cubes 4,5 cm</i> 11x11 cm   4,5 cm pack: 1</p>
	<p>30.41584 καλούπι πάγου σιλικόννης για 4 σφηνάκια πάγου <i>silicone ice mold for 4 ice shots</i> 12,2x12,2 cm   6 cm pack: 1</p>		<p>30.41581 καλούπι πάγου σιλικόννης για κύβους 5 cm <i>silicone ice mold for ice cubes 5 cm</i> 17x11 cm   5,2 cm pack: 1</p>
	<p>30.41046 καλούπι πάγου καουτσούκ, 32 θέσεων <i>soft rubber ice mold for 32 ice shots</i> 33,5x18 cm   6 cm pack: 1</p>		<p>30.41580 καλούπι πάγου σιλικόννης για κύβους 3 cm <i>silicone ice mold for ice cubes 3 cm</i> 19x12 cm   3,5 cm pack: 1</p>

μεταφορά πάγου | *cool boxes*

	<p>ψυγεία, μπλε   <i>cool boxes, blue</i></p> <p>21.59907 10 lt 42,8x26,5 cm   23,3 cm pack: 6</p> <p>21.59569 32 lt 49,8x33,3 cm   41 cm pack: 1</p>
	<p>21.46688 32 lt 49,8x33,3 cm   41 cm pack: 1</p>

	<p>27.12990 καλούπι πάγου, για σφαίρες πάγου 6 cm <i>ice mold for ice spheres 6 cm</i> 23,5x8,5 cm   6,5 cm pack: 1</p>
--	---

παγοθραύστες | *ice-picks*

	<p>30.41574 παγοθραύστης χειρός χρωμίου με inox λάμες και σέσουλα <i>chrome plated ice crusher with inox blades and ice scoop</i> 16x14 cm   27 cm pack: 1</p>
	<p>*27.36017 παγοθραύστης χειρός με inox λάμες <i>ice crusher with inox blades</i> 12x12 cm   24 cm pack: 1</p>

# Tiki mugs

34.60392  
hammered mug  
inox, 55 cl  
7,5 cm | 10 cm  
pack: 1



GenWare



APS

\*27.93373  
mug antique, 35 cl  
7,5 cm | 10,5 cm  
pack: 1



APS

\*27.93372  
mug black, 35 cl  
7,5 cm | 10,5 cm  
pack: 1

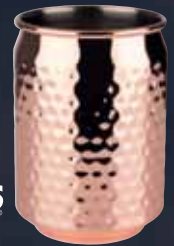

\*27.93371  
mug copper, 35 cl  
7,5 cm | 10,5 cm  
pack: 1

28.00216  
julep mug copper  
37,5 cl  
8,8 cm | 11,5 cm  
pack: 6/48



APS

28.00215  
julep mug  
37,5 cl  
8,8 cm | 11,5 cm  
pack: 6/48



GenWare

34.60150  
hammered mug  
«pineapple», 44 cl  
8,7 cm | 9 cm  
pack: 1



28.00010  
julep mug  
38,5 cl  
8,4 cm | 10,5 cm  
pack: 1

APS



APS

27.40617  
serving pot, copper  
30 cl  
8,5 cm | 8,5 cm  
pack: 1



27.40616  
serving pot, copper  
35 cl  
9,5 cm | 8,5/11,5 cm  
pack: 1



APS

27.40607  
hammered mug  
inox  
8,5 cm | 8,5 cm  
pack: 1



APS

27.40618  
hammered mug  
copper  
8,5 cm | 8,5 cm  
pack: 1



34.60002  
hammered mug  
copper  
9,5 cm | 11,6 cm  
pack: 1



GenWare



34.60001  
hammered mug  
inox  
9,5 cm | 11,6 cm  
pack: 1

28.00244  
κούπα σφυρήλατη  
copper  
embossed copper mug  
35,5 cl  
8,4 cm | 11,3 cm  
pack: 1/24



APS

28.00245  
κούπα σφυρήλατη  
copper  
embossed copper mug  
65,1 cl  
9,9 cm | 15,1 cm  
pack: 1/24

# Tiki mugs

35.02436  
copper mule  
διπλού τοιχώματος,  
double wall  
37 cl  
9 cm | 11,7 cm  
pack: 1



KitchenCraft

34.60071  
hammered mule  
«Gun metal black»  
55 cl  
8,5 cm | 9,8 cm  
pack: 1/12



GenWare



28.00174  
copper mule  
45 cl  
9 cm | 9 cm  
pack: 12

APS

GenWare

34.60149  
copper mule  
50 cl  
9,5 cm | 9,5 cm  
pack: 1/12



28.00218  
hammered  
copper mule  
60 cl  
12,5 cm | 11 cm  
pack: 1/36



APS



35.02435  
hammered copper mule  
55 cl  
9 cm | 9,5 cm  
pack: 1

KitchenCraft

30.80416  
copper antique  
mule  
45 cl  
8,5 cm | 10 cm  
pack: 1



APS

27.93332  
pineapple antique  
look  
50 cl  
9,5 cm | 10 cm  
pack: 1



HENDI

30.42238  
mule mug, copper  
40 cl  
8,5 cm | 10,5 cm  
pack: 1



HENDI

30.42237  
mule mug, copper  
50 cl  
9,7 cm | 10 cm  
pack: 1

GenWare

34.60148  
hammered mule  
vintage  
40 cl  
8,5 cm | 9 cm  
pack: 1/12



27.93365  
beer mug, inox  
stainless antique  
8,5 cm | 13 cm  
pack: 1



APS

27.93364  
beer mug, inox  
copper antique  
8,5 cm | 13 cm  
pack: 1

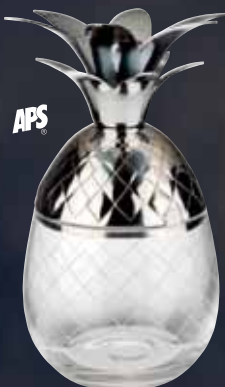

APS

\*27.93375  
«Ανανάς» γυάλινος  
με inox καπάκι  
pineapple glass with inox lid  
8,5 cm | 17,5 cm  
35 cl  
pack: 1

## Tiki mugs



GenWare

34.60391  
tiki mug «Rocks»  
λευκό | *white*, 36 cl  
8,3 cm | 10,2 cm  
pack: 4



34.60387  
tiki mug «Rocks»  
καφέ | *brown*, 36 cl  
8,3 cm | 10,2 cm  
pack: 4



GenWare

34.60389  
tiki mug «Rocks»  
πράσινο | *green*, 36 cl  
8,3 cm | 10,2 cm  
pack: 4



GenWare

34.60388  
tiki mug «Rocks»  
cast iron, 36 cl  
8,3 cm | 10,2 cm  
pack: 4



GenWare

34.60390  
tiki mug «Rocks»  
μωβ | *purple*, 36 cl  
8,3 cm | 10,2 cm  
pack: 4



GenWare

34.60386  
tiki mug «Rocks»  
μπλε | *blue*, 36 cl  
8,3 cm | 10,2 cm  
pack: 4



GenWare

34.60268  
tiki mug  
«Pineapple»  
brown  
40 cl  
9,3 cm | 10 cm  
pack: 1



34.60269  
tiki mug  
«Pineapple»  
green  
40 cl  
9,3 cm | 10 cm  
pack: 1

APS



28.00246  
tiki mug  
«Reptil»  
43 cl  
9,7 cm | 9,7 cm  
pack: 1

352

ΠΟΤΗΡΙΑ COCKTAIL



APS

28.00014  
«Aku Aku»  
30 cl  
7,6x7,3 cm | 16,5 cm  
pack: 1/6

APS



28.00223  
«Indian»  
mug με καπάκι  
*mug with lid*  
55 cl  
11 cm | 16 cm  
pack: 1/24



APS

28.00016  
«Holua Loa»  
35 cl  
7,2 cm | 16,5 cm  
pack: 1/6



APS

28.00021  
«Fu Manchu»  
36 cl  
8 cm | 17,6 cm  
pack: 1/6



APS

28.00011  
«Bam Boo»  
40 cl  
8 cm | 15 cm  
pack: 1/6



# Tiki mugs



GenWare  
34.60154  
καφέ | brown  
40 cl  
7,5 cm | 16,5 cm  
pack: 4



GenWare  
34.60385  
tiki mug  
λευκό | white  
40 cl  
7,5 cm | 16 cm  
pack: 4



GenWare  
34.60382  
tiki mug «Cactus»  
42 cl  
7,9 cm | 12,2 cm  
pack: 4



GenWare  
34.60072  
μωβ | purple  
40 cl  
7,5 cm | 16,5 cm  
pack: 4



APS  
28.00247  
tiki mug  
«Dragonfly»  
45 cl  
8,1 cm | 15 cm  
pack: 1



APS  
28.00248  
tiki mug «Dragon»  
50 cl  
8 cm | 17 cm  
pack: 1



GenWare  
34.60153  
πράσινο | green  
40 cl  
7,5 cm | 16,5 cm  
pack: 4



34.60267  
tiki mug «Bamboo»  
50 cl  
7,7 cm | 16,8 cm  
pack: 1



APS  
28.00015  
«Hua Kai»  
42 cl  
7,5 cm | 17 cm  
pack: 1/6



GenWare  
34.60073  
σιέλ | blue  
40 cl  
7,5 cm | 16,5 cm  
pack: 4



APS  
28.00012  
«Kuna Loa»  
33 cl  
7 cm | 17 cm  
pack: 1



APS  
28.00144  
σετ 3 tiki mugs  
25 cl  
6,7 cm | 14,2 cm  
pack: 1/6



GenWare  
34.60161  
cast iron effect  
μαύρο | black  
40 cl  
7,5 cm | 16,5 cm  
pack: 4





# Tiki mugs



28.00158  
«Shrink Head»  
50,5 cl  
12,5x10,7 cm | 10 cm  
pack: 1/6

APS



28.00023  
«Coconut»  
56,5 cl  
11,3 cm | 10 cm  
pack: 1/6

APS



28.00020  
«Maitai»  
43 cl  
9,7 cm | 10 cm  
pack: 1/6

APS



34.60270  
tiki skull mug  
stone cast effects  
40 cl  
9,5 cm | 11,3 cm  
pack: 1

GenWare



34.60383  
tiki skull mug  
λευκό | white, 40 cl  
9,5 cm | 11,3 cm  
pack: 1

APS

28.00222  
«Monkey»  
55 cl  
12,5/12 cm | 11 cm  
pack: 1/24



28.00221  
«Monkey»  
55 cl  
12,5/12 cm | 11 cm  
pack: 1/24

APS

34.60152  
tiki skull mug  
stone cast effects  
80 cl  
11x13,5 cm | 12 cm  
pack: 1/6



GenWare



34.60384  
tiki skull mug  
λευκό | white  
80 cl  
11x13,5 cm | 12 cm  
pack: 1/6



34.60007  
δοχείο inox, 34 cl  
εφαρμόζει στο  
δοχείο βασάλτη  
pack: 1

GenWare



34.60006  
δοχείο βασάλτη  
11,2 cm | 9,7 cm  
να μην έρχεται  
σε επαφή με ποτά  
pack: 1

00.10077  
«Bartender Sweet»  
44 cl  
8,5 cm | 11,7 cm  
pack: 6



00.10076  
«Bartender Sour»  
45,5 cl  
8,5 cm | 11,7 cm  
pack: 6



37.56880  
tiki «Peanapple»  
48 cl  
8 cm | 14 cm  
pack: 12

onix



28.00213  
κυλινδρικό  
δοχείο/μεζούρα  
lab beaker, 25 cl  
7,7 cm | 9,7 cm  
pack: 1/8

APS



93.92142  
rocks  
47,3 cl  
7 cm | 11,7 cm  
pack: 12

onix



93.92143  
cooler  
59,1 cl  
7,6 cm | 16,5 cm  
pack: 12

onix

28.00025  
tiki cup, 41,4 cl  
10x8,5 cm | 12 cm  
pack: 1/24

APS



30.80268  
«Skull» shot  
6 cl  
5,2 cm | 6 cm  
pack: 12



28.00018  
«Skull» large  
150 cl  
16,5x14,7 cm | 15 cm  
pack: 1/8

APS



28.00019  
«Skull» medium  
70 cl  
13,7x11,5 cm | 11,5 cm  
pack: 1/12

APS



28.00022  
«Skull» small  
9 cl  
7,3x6,3 cm | 6,8 cm  
pack: 1/48

APS

# σκεύη μιας χρήσης

**sier**  
disposables

30.72003  
πίατο ζαχαροκάλαμου (40 τμχ.)  
20x12 cm | 1,5 cm  
pack: 12



30.72000  
πίατο ζαχαροκάλαμου (40 τμχ.)  
24 cm | 1,5 cm  
pack: 12



30.72006  
πίατο ζαχαροκάλαμου Organic (40 τμχ.)  
23x18 cm | 3 cm  
pack: 12



30.72002  
μπολ ζαχαροκάλαμου  
(20 τμχ.)



30.72005  
πίατο ζαχαροκάλαμου Organic (40 τμχ.)  
15x18 cm | 3 cm  
pack: 12



30.72001  
μπολάκι ζαχαροκάλαμου  
Organic (40 τμχ.)  
7 cm | 2 cm  
pack: 12



30.72004  
amuse bouche  
ζαχαροκάλαμου (40 τμχ.)  
11x6 cm | 2 cm  
pack: 12



πίατο «Palm» (20 τμχ.)

30.72007  
23 cm | 2 cm  
pack: 12



30.72011  
μπολ Palm (40 τμχ.)  
7 cm | 2,5 cm  
pack: 12



30.72008  
25 cm | 3 cm  
pack: 12

30.72009  
πίατο «Palm» (20 τμχ.)  
25x25 cm | 2 cm  
pack: 12



πίατο οβάλ «Palm» (20 τμχ.)

30.72012  
20x12,7 cm  
pack: 12



30.72013  
26x16,5 cm  
pack: 12

30.72015  
μπολ φυσικής καρύδας (10 τμχ.)  
8/13 cm  
pack: 12



30.72014  
μπολ λοξό «Palm»  
(20 τμχ.)  
14x10 cm  
pack: 12



30.72016  
μπολ φυσικής καρύδας  
(10 τμχ.)  
11/15 cm  
pack: 12



30.72010  
πίατο «Palm»  
(20 τμχ.)  
14x14 cm | 5 cm  
pack: 12



## καλαμάκια χάρτινα

APS



28.00167 8255-ASS  
καλαμάκι χάρτινο  
διάφορα χρώματα  
(100 τμχ.)  
0,8 cm | 25,5 cm  
pack: 10



28.00168 8255-BLU  
καλαμάκι χάρτινο  
μπλε, (100 τμχ.)  
0,8 cm | 25,5 cm  
pack: 10



28.00165 8255-RED  
καλαμάκι χάρτινο  
κόκκινο, (100 τμχ.)  
0,8 cm | 25,5 cm  
pack: 10



28.00166 8255-GRY  
καλαμάκι χάρτινο  
γκρι, (100 τμχ.)  
0,8 cm | 25,5 cm  
pack: 10



28.00163 8255-FLO  
καλαμάκι χάρτινο  
λουλούδια, (100 τμχ.)  
0,8 cm | 25,5 cm  
pack: 10



28.00164 8255-RWB  
καλαμάκι χάρτινο  
μπλε/λευκό/κόκκινο  
(100 τμχ.)  
0,8 cm | 25,5 cm  
pack: 10

«Campo»

30.10484  
κανάτα θερμός  
κόκκινη  
1ltr  
vacuum jug,  
double-walled, red  
23,5 cm  
pack: 1



30.10485  
κανάτα θερμός  
λευκή  
1ltr  
vacuum jug,  
double-walled, white  
23,5 cm  
pack: 1



30.10486  
κανάτα θερμός  
μαύρη  
1ltr  
vacuum jug,  
double-walled, black  
23,5 cm  
pack: 1



«Eleganza» κανάτες θερμός inox, ισοθερμικές  
double walled stainless steel vacuum jugs



30.10139  
κανάτα θερμός  
vacuum jug, 0,3 lt  
pack: 1



30.10137  
κανάτα θερμός  
vacuum jug, 0,6 lt  
pack: 1



30.10138  
κανάτα θερμός  
vacuum jug, 1 lt  
pack: 1



30.10187  
κανάτα διπλού  
τοιχώματος 18/10  
double walled pitcher  
1,8 lt  
pack: 1

«Vision»



\*30.10190  
γαλατιέρα | milk jug  
0,18 lt  
pack: 1

\*30.10192  
ζαχαριέρα | sugar bowl  
0,10 lt  
pack: 1

\*30.10191  
καπάκι | lid,  
6 cm  
pack: 1

«Neutral»



30.10057  
ισοθερμική καφετιέρα inox 18/10  
double walled coffee pot, 0,6 lt  
pack: 1  
διαθέσιμη και σε 0,15 - 0,3 και 1,2 lt



30.10058  
ισοθερμική τσαγιέρα inox 18/10  
με φίλτρο  
double walled tea pot, with filter, 0,6 lt  
pack: 1  
διαθέσιμη και σε 1,2 lt

δισκάκι ξηρών καρπών  
ή για μπουκάλια, inox  
tray for snack or bottles

\*30.10178 10,1 cm  
pack: 1

\*30.10179 14,2 cm  
pack: 1



\*30.10177  
stand ξηρών καρπών  
με χερούλι, inox  
3-part snack stand  
24,7 cm  
pack: 1



\*30.10176  
stand ξηρών καρπών  
με χερούλι, inox  
4-part snack stand  
22,8 cm  
pack: 1



\*30.10175  
stand ξηρών καρπών  
με χερούλι, inox  
3-part snack stand  
(3x)8,9 cm | 16,8 cm  
pack: 1



emisa

**\*30.10186**  
ισοθερμική βάση  
κρασιού με παγοκύστη  
*isolated wine cooler*  
15 cm | 23,7 cm  
pack: 1



**\*30.10490**  
ισοθερμική θήκη  
μπουκαλιού  
inox 18/10  
*bottle-cooler insulated,  
double-walled*  
12 cm | 19 cm  
pack: 1



**\*30.10180**  
επάργυρο καλάθι σερβιρίσματος  
μπουκαλιού κρασιού  
*silver-plated wine basket for bottle 0,75 ltr*  
24,8x11 cm |  
pack: 1



**\*30.10493**  
κουβαδάκι πάγου  
inox 18/10  
*ice bucket*  
12,6 cm | 12,1 cm  
pack: 1



**\*30.10243**  
δοχείο πάγου ισοθερμικό  
με λαβίδα  
inox 18/10  
*ice bucket with ice tongs,  
double-walled*  
15 cm | 16,3 cm  
pack: 1



emisa

**\*30.10141**  
«Prestige»  
γυάλινη κανάτα  
με inox στόμιο,  
ψυχόμενη  
με παγοκύστη,  
*glass carafe  
with cooling base*  
33,5 cm  
1 lt  
pack: 6



«Profile»

**\*30.10184**  
σαμπανιέρα διπλή  
inox, 7 ltr  
*bucket inox*  
23,1 cm | 24,7 cm  
pack: 1



«Excellent»

**\*30.10492**  
σαμπανιέρα μονή  
inox, 4,7 ltr  
*bucket inox*  
18,9 cm | 21,9 cm  
pack: 1



«Profile»

**\*30.10489**  
σαμπανιέρα μονή  
inox, 4,7 ltr  
*bucket inox*  
18,9 cm | 21,9 cm  
pack: 1



**\*30.10185**  
σταντ inox,  
*stand inox*  
18 cm | 68,8 cm  
pack: 1



**\*30.10491**  
σταντ inox,  
*stand inox*  
16,2 cm | 67,6 cm  
pack: 1



**\*30.10183**  
σταντ inox,  
*stand inox*  
67,6 cm  
pack: 1

# «Hevea»

to keep bottles cool

**PEDRALI**

Το σετ σαμπανιέρας Hevea, αποιερείται από τη μεταλλική βάση με powder coated βαφή και την σαμπανιέρα από ποδυπροπυλένιο. Η σαμπανιέρα συνδέεται με τη βάση μέσω ενός μεταλλικού γάντζου και είναι εύκολα αποσπώμενη. Λιτός σχεδιασμός σε δυο χρώματα λευκό και μαύρο, κατάλληλη και για εξωτερικό χώρο.

Έχει τη δυνατότητα να γίνει διπλή προσθέτοντας μια ακόμη σαμπανιέρα, η οποία πωλείται ξεχωριστά.

The Hevea ice bucket set consists of the powder coated metal stand and the bucket made by polypropylene. The bucket is hanged on the stand with a metal hook and is easily removable. Minimal design in two colors white and black, also suitable for outdoor use.

It can be used as double by adding another bucket, which is sold separately.

designed by  
Victoria Azadinho Bocconi

05.52003  
σετ σαμπανιέρα μαύρη  
με ατσάλινη βάση  
και PP σαμπανιέρα  
set of st. steel black stand  
and PP bucket  
34x42,5 cm | 85 cm  
pack: 1

05.52004  
σαμπανιέρα PP μαύρη  
PP bucket, black  
21 cm | 20 cm  
pack: 1



## stands για σαμπανιέρες | stands for wine buckets



30.40209  
σταντ inox  
5 τμημάτων  
inox stand (5 pcs.)  
74 cm  
pack: 1

HENDI

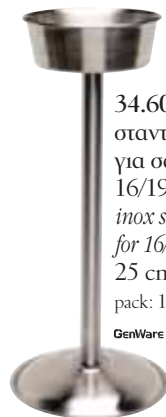

34.60008  
σταντ inox  
για σαμπανιέρες  
16/19 cm  
inox stand  
for 16/19 cm bottoms  
25 cm | 56 cm  
pack: 1

GenWare

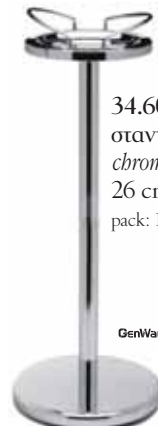

34.60009  
σταντ chrome  
chrome stand  
26 cm | 68 cm  
pack: 1

GenWare



30.71342  
σταντ inox  
inox stand  
16 cm | 62 cm  
pack: 1

bonbistro



30.71120  
σταντ inox, σφυρή-  
λατο, μαύρο ματ  
black matt hammered  
stand  
63 cm  
pack: 1

bonbistro

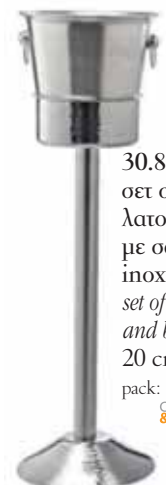

30.80496  
σετ σταντ σφυρή-  
λατο  
με σαμπανιέρα,  
inox  
set of hammered stand  
and bucket, inox  
20 cm | 63 cm  
pack: 1

Cosy  
& Trendy



27.36069  
σταντ inox  
inox stand  
17,5/26,5 cm | 73 cm  
pack: 1

APS



30.40895  
επιτραπέζια βάση  
σαμπανιέρας  
(δαχτυλίδι 18 cm)  
wine cooler table bracket  
(ring 18,5 cm)  
19,5 cm | 51 cm  
pack: 1

HENDI

σαμπανιέρες | wine/champagne buckets

 <p>bonbistro</p>	<p>30.71118 σαμπανιέρα, inox σφυρήλατη, μαύρη matt <i>hammered bucket, inox, black matt</i> 21,5 cm   21 cm pack: 1</p>	 <p>APS</p>	<p>27.36028 σαμπανιέρα, inox <i>inox bucket, 4 lt</i> 21,5916 cm   22 cm pack: 1</p>
 <p>Cosy &amp; Trendy</p>	<p>30.80091 «Tub» 469948 σαμπανιέρα μαύρη <i>bucket, black</i> 21 cm   21 cm pack: 1</p>	 <p>bonbistro</p>	<p>30.71267 σαμπανιέρα bowl, σφυρήλατη, inox, μαύρη <i>inox hammered black champagne bowl</i> 39,5 cm   24,5 cm pack: 1</p>
 <p>Cosy &amp; Trendy</p>	<p>30.80417 σαμπανιέρα   <i>bucket antique</i> 21 cm   21 cm pack: 1</p>	 <p>Cosy &amp; Trendy</p>	<p>30.80011 σαμπανιέρα bowl, inox, μαύρη <i>inox black champagne bowl</i> 31 cm   18 cm pack: 1/6</p>
 <p>APS</p>	<p>27.36026 σαμπανιέρα, σφυρήλατη, inox <i>hammered inox bucket</i> 21 cm   21,5 cm pack: 1</p>	 <p>HENDI</p>	<p>30.40264 σαμπανιέρα bowlm, inox, <i>inox champagne bowl</i> 9,5 lt 35 cm   23 cm pack: 1</p>
 <p>GenWare</p>	<p>34.60260 σαμπανιέρα, inox <i>inox bucket</i> 15,7 cm   17,8 cm pack: 1</p>	 <p>bonbistro</p>	<p>30.71269 σαμπανιέρα bowl inox, <i>inox champagne tub</i> 32 cm pack: 1</p>
 <p>HENDI</p>	<p>30.40084 σαμπανιέρα, inox <i>inox bucket, 3,5 lt</i> 21 cm   21 cm pack: 1</p>	 <p>APS</p>	<p>*27.93330 «Moscow mule XXL» σαμπανιέρα bowl σφυρήλατη, copper <i>hammered copper champagne tub</i> 30 cm   30 cm pack: 1</p>
 <p>Budget</p>	<p>30.40266 σαμπανιέρα, inox <i>inox bucket, 3,3 lt</i> 19 cm   19 cm pack: 1</p>		<p>30.41685 κάδος για μπύρες, με ενσωματωμένο ανοιχτήρι <i>beer bucket with bottle opener integrated in the handle.</i> 23 cm   18 cm pack: 1</p>

σαμπανιέρες | *wine/champagne buckets*

APS



σαμπανιέρα inox σφυρήλατη  
διπλού τοιχώματος, 8 lt  
*wine / champagne bowl, hammered surface  
double-walled, 8 lt*  
33 cm | 20 cm

\*27.36120 inox  
pack: 1



σαμπανιέρα inox σφυρήλατη  
διπλού τοιχώματος, 8 lt  
*wine / champagne bowl, hammered surface  
double-walled, 8 lt*  
33 cm | 20 cm

\*27.36121 copper-look  
pack: 1

APS



σαμπανιέρα αλουμινίου σφυρήλατη,  
με λαβές, 7 lt  
*wine / champagne bowl, hammered surface  
with 2 handles on the side*  
30x23,5 cm | 23 cm

\*27.36111 copper  
pack: 1



σαμπανιέρα αλουμινίου σφυρήλατη,  
με λαβές, 7 lt  
*wine / champagne bowl, hammered surface  
with 2 handles on the side*  
30x23,5 cm | 23 cm

\*27.36112 gunmetal  
pack: 1



APS

\*27.36096 σαμπανιέρα γαλβανιζέ,  
με πλαστικό δοχείο  
*champagne bowl  
galvanised, with plastic insert*  
50x32 cm | 23 cm  
pack: 1



APS

\*27.36100 σαμπανιέρα γαλβανιζέ,  
χάλκινη με πλαστικό  
δοχείο  
*champagne bowl copper  
galvanised, with plastic insert*  
40x28 cm | 22 cm  
pack: 1



APS

\*27.36101 σαμπανιέρα γαλβανιζέ,  
μαύρη με πλαστικό  
δοχείο  
*champagne bowl black  
galvanised, with plastic insert*  
40x28 cm | 22 cm  
pack: 1



HENDI

30.41577 σαμπανιέρα bowl inox,  
*inox champagne tub*  
40x33 cm | 22 cm  
pack: 1



 <p>HENDI</p>	<p>30.40265 σαμπανιέρα, πλαστική <i>plastic champagne tub</i> 10 lt 47x29 cm   23 cm pack: 1</p>	 <p>APS</p>	<p>27.36052 σαμπανιέρα πλαστική (MS), διάφανη διατίθεται και σε μαύρη <i>plastic wine / champagne bowl, clear</i> also available in black 27x20 cm   21 cm pack: 1</p>
 <p>APS</p>	<p>27.36048 σαμπανιέρα πλαστική <i>plastic champagne tub (MS)</i> 6,2 lt 35x27 cm   25,5 cm pack: 1</p>	 <p>APS</p>	<p>27.36056 σαμπανιέρα, πλαστική <i>plastic wine / champagne bowls (MS)</i> 30,5x21,5 cm   26 cm pack: 1</p>
 <p>APS</p>	<p>σαμπανιέρες πλαστικές διάφανες <i>plastic transparent champagne tubs (MS)</i>  *27.36087 διάφανη   <i>clear</i> 32x21,5 cm   24,5 cm pack: 1/6</p>	 <p>KitchenCraft</p>	<p>35.00436 σαμπανιέρα ακρυλική δύο μπουκαλιών <i>acrylic bucket for 2 bottles</i> 25x19 cm   28 cm pack: 1/6</p>
 <p>APS</p>	<p>27.36054 σαμπανιέρα πλαστική (MS), μαύρη <i>plastic wine / champagne bowl, black</i> 6,2 lt 35x27 cm   25,5 cm pack: 1</p>	 <p>KitchenCraft</p>	<p>35.00112 σαμπανιέρα ακρυλική <i>acrylic bucket</i> 20 cm   26 cm pack: 1/6</p>
		 <p>APS</p>	<p>27.36066 σαμπανιέρα ακρυλική <i>acrylic bucket</i> 14/22 cm   23 cm pack: 1</p>
		 <p>HENDI</p>	<p>30.41047 σαμπανιέρα ακρυλική <i>acrylic bucket</i> 22x18,5 cm   22,6 cm pack: 1/6</p>



wine cooler ισοθερμικά | *isolated wine*

	<p>30.71121 wine cooler, inox ισοθερμικό, σφυρήλατο, μαύρο ματ <i>isolated, black matt</i> 12 cm   19,5 cm pack: 1</p>		<p>27.36090 wine cooler ισοθερμικό, τοιμεντένιο <i>isolated concrete</i> 12/10 cm   19 cm pack: 1</p> <p>27.36099 wine cooler μαύρο ισοθερμικό, τοιμεντένιο <i>bottle cooler, isolated concrete black</i> 12/10 cm   19 cm pack: 1</p>
	<p>*27.36074 wine cooler, copper ισοθερμικό, σφυρήλατο <i>isolated, hammered</i> 12 cm   20 cm pack: 1</p>		<p>10.90093 ισοθερμική θήκη κρασιού <i>cool collar</i> 8/11 cm   17 cm pack: 1</p>
	<p>34.60076 wine cooler, copper ισοθερμικό   <i>isolated</i> 003C 12 cm   20 cm pack: 6</p>		<p>27.36075 «θήκη» cooler PE με τζελ, παγώνει τα μπουκάλια σε 5 λεπτά <i>cool collar bottles will be cooled down in only 5 minutes</i> 11 cm   18 cm pack: 1</p>
	<p>60.34000 wine cooler, inox ισοθερμικό   <i>isolated</i> 12 cm   19,5 cm pack: 1/30</p>		<p>30.41048 wine cooler EPP διατηρεί κρύο το μπουκάλι περισσότερο από τα μεταλλικά <i>keeps wine cool longer than regular inox coolers</i> 14,2 cm   21 cm</p>
	<p>27.36032 wine cooler, acrylic ισοθερμικό   <i>isolated</i> 12 cm   23 cm pack: 1</p>		

σπαθί σαμπάνιας | *sabre for champagne bottle*

		<p>σπαθί σαμπάνιας <i>sabre for champagne bottle</i></p> <p>30.80440 σπαθί σαμπάνιας <i>sabre for champagne bottle</i> 43,5 cm pack: 6</p> <p>10.50028 κόπτης προστατευτικού πώματος σαμπάνιας <i>champagne plier</i> 15,8 cm pack: 1</p>
---	--	---

 <p>KitchenCraft</p>	<p>35.00108 θερμόμετρο φιάλης <i>bottle thermometer</i> pack: 6/144</p>	 <p>HENDI</p>	<p>30.42232 σετ 6 πώματα φιαλών με καπάκι <i>bottle stopper ribbed cork with cap</i> pack: 1</p>
 <p>GHIDINI</p>	<p>10.40512 περιλαίμιο φιάλης κρασιού, γυαλιστερό <i>wine collar</i> pack: 1</p>	 <p>KitchenCraft</p>	<p>35.00435 αντλία / φιάλης κρασιού <i>wine pump</i> pack: 6/72</p> <p>35.00164 αντλία και δύο πώματα φιάλης κρασιού <i>wine pump with 2 stoppers</i> pack: 6/72</p> <p>35.01317 σετ 2 αντ/κά πώματα <i>spare part 2 stoppers</i> pack: 6/72</p>
 <p>GHIDINI</p>	<p>10.40350 πώμα ελέγχου ροής <i>wine pourer</i> pack: 12/72</p>	 <p>GHIDINI</p>	

παγοθραύστες | *ice-picks*

 <p>APS</p>	<p>28.00234 παγοθραύστης mini <i>mini ice-pick</i></p>
 <p>BARFLY</p>	<p>30.41585 παγοθραύστης με 6 βελόνες <i>ice-pick with 6 spikes</i> 21 cm pack: 1</p> <p>30.41587 παγοθραύστης Japanese <i>ice-pick</i> 18 cm pack: 1</p>
 <p>BARFLY</p>	<p>30.41586 ξύλινο σφυρί πάγου <i>wooden ice mallet</i> 34,3 cm pack: 1</p>

\*27.30333 stand μπουκαλιών μεταλλικό  
*winebottle stand, mettalic*  
22x6 cm | 20,5 cm  
pack: 1



35.02481 stand 7 μπουκαλιών στοιβαζόμενο, copper  
*copper finish stackable wine rack*  
58,8x14,5 cm | 15 cm  
pack: 1

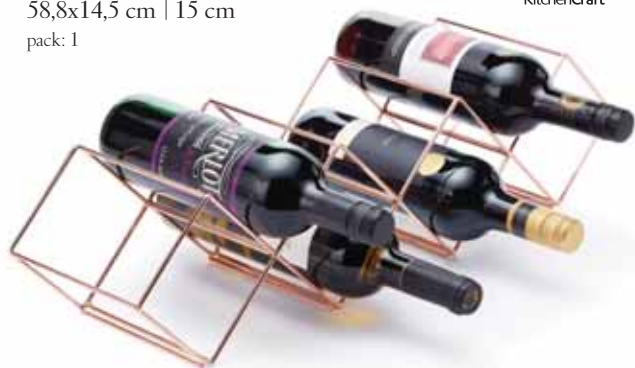

κανάτες / καράφες | decanters / pitchers / jugs



κρυστάλλινη καράφα  
«Classico»  
08.00124  
0,75 lt / 2 lt  
22 cm | 25 cm  
pack: 1/4



γυάλινη καράφα  
«Atelier»  
08.00478  
0,25 lt  
7,3 cm | 17,4 cm  
pack: 6

08.00479  
0,5 lt  
9 cm | 22,5 cm  
pack: 6

08.00481  
1 lt  
10,8 cm | 28 cm  
pack: 6



γυάλινη κανάτα  
«Colonna»  
01.35104  
1 lt (13 cm | 20 cm)  
pack: 6  
01.35105  
1,3 lt (14 cm | 21,6 cm)  
pack: 6  
01.35106  
με καπάκι  
1,3 lt (14 cm | 21,6 cm)  
pack: 6



γυάλινη καράφα  
«Premium»  
00.70134  
2 lt  
21 cm | 24 cm  
pack: 1/2



γυάλινη καράφα  
«Ypsilon»  
00.70200  
0,3 lt  
6,8 cm | 16,5 cm  
pack: 12

00.70201  
0,5 lt  
8,4 cm | 20,4 cm  
pack: 12

00.70202  
1 lt  
10,4 cm | 25,5 cm  
pack: 6



κανάτα tempered  
*decantertempered*  
31.85060  
1 lt  
13,3 cm | 19,7 cm  
pack: 1  
31.85061  
2 lt  
16,1 cm | 23,6 cm  
pack: 1



γυάλινη καράφα  
«Gamma»  
00.70135  
1,6 lt  
21 cm | 21,1 cm  
pack: 1/3



00.35050  
«Kurfa» γυάλινη  
με εσωτερικό δοχείο  
πάγου | *internal ice insert*  
2,15 lt  
16,5 cm | 21,5 cm  
pack: 6



γυάλινη καράφα  
«Loto»  
00.70040  
1,3 lt  
13,4 cm | 30,8 cm  
pack: 6



γυάλινη καράφα  
«Indro»  
01.35031  
0,25 lt  
6,9 cm | 15,5 cm  
pack: 6

01.35032  
0,5 lt  
8,2 cm | 19,5 cm  
pack: 6

01.35033  
1 lt  
8,2 cm | 28 cm  
pack: 6



01.35051  
«Piacenza» γυάλινη  
με καπάκι | *with lid*  
1,6 lt  
10,4 cm | 20,5 cm  
pack: 6



γυάλινη καράφα  
«Misura»  
00.70100  
0,25 lt  
6,8 cm | 19 cm  
pack: 12

00.70101  
0,5 lt  
8,4 cm | 23,5 cm  
pack: 12

00.70102  
1 lt  
10,8 cm | 26,2 cm  
pack: 12



γυάλινη κανάτα  
«Bistrot»  
00.35010  
0,3 lt  
6,2 cm | 11,5 cm  
pack: 24

00.35011  
0,6 lt  
7,7 cm | 14,5 cm  
pack: 12

00.35012  
1,1 lt  
9,3 cm | 18,6 cm  
pack: 6



34.60394  
κανάτα  
inox, copper  
2 lt  
13,5 cm | 23,5 cm  
pack: 1





\*27.10764  
κανάτα γυάλινη  
με ίnox καπάκι  
glass decanter; inox cover  
1,5 lt  
9,5 cm | 27 cm  
pack: 1



\*27.10792  
κανάτα γυάλινη  
με καπάκι ματ  
glass carafe, with inox lid  
1,5 lt  
10 cm | 26 cm  
pack: 1



«lock eat»  
γυάλινες καράφες  
με πόμα  
carafes with lid  
**08.00910**  
0,5 lt  
7,3 cm | 21,1 cm  
pack: 6/12  
**08.00911**  
καράφα με πόμα  
1 lt  
10,2 cm | 27,7 cm  
pack: 6/12



\*27.10766  
μπουκάλι γυάλινο  
με καπάκι σιλικόνης  
decanter; inox cover  
1,5 lt  
9,5 cm | 27 cm  
pack: 1



\*27.10762  
σετ μπουκάλι γυάλινο  
με ψυχόμενη βάση  
και παγοκύστη  
για διατήρηση 4 ωρών  
1 glass carafe with s.steel  
pouwer; 1 chrome plated  
base 1 cooling pack  
1,4 lt  
16 cm | 27 cm  
pack: 1  
**\*27.10761**  
καράφα | glass carafe  
1,4 lt (16 cm | 27 cm)  
pack: 1



**01.35054**  
γυάλινη φιάλη «Argo»  
με μπλε καπάκι  
glass bottle «Argo»  
blue lid  
1 lt  
8,8 cm | 26,8 cm  
pack: 1

**01.35053**  
γυάλινη φιάλη  
«Fenice»  
με μπλε καπάκι  
glass bottle «Fenice»  
blue lid  
1 lt  
8,8 cm | 26,8 cm  
pack: 1



**00.70127**  
γυάλινο μπουκάλι  
glass bottle  
«Quattro Stagioni»  
1 lt  
pack: 12



**00.70128**  
γυάλινο μπουκάλι  
glass bottle  
«Quattro Stagioni»  
1 lt  
pack: 12



γυάλινο μπουκάλι  
glass bottle  
«Indro»  
**01.70051**  
35 cl  
9 cm | 20 cm  
pack: 6  
**01.70050**  
1 lt  
9 cm | 32 cm  
pack: 6



γυάλινο μπουκάλι  
glass bottle, «Swing»  
**00.70153**  
12,5 cl (5 cm | 14,5 cm)  
pack: 20  
**00.70151**  
25 cl (5,5 cm | 19,2 cm)  
pack: 12  
**00.70152**  
50 cl (6,6 cm | 25,3 cm)  
pack: 12  
**00.84016**  
1 lt (8,2 cm | 31,5 cm)  
pack: 20



**08.00512**  
γυάλινο μπουκάλι  
glass bottle  
«Hydrosommelier»  
1 lt  
8,5 cm | 35 cm  
pack: 6



**08.00393**  
καπάκι «Optima»  
lid for bottles  
1 - 0,75 - 0,5 lt  
pack: 6



φιάλες κρασιού  
wine bottles  
**08.00385**  
0,25 lt  
6 cm | 19,6 cm  
pack: 6  
**08.00386**  
0,5 lt  
7,1 cm | 26,2 cm  
pack: 6  
**08.00387**  
0,75 lt  
8 cm | 29,5 cm  
pack: 6  
**08.00392**  
1 lt  
8,8 cm | 31,8 cm  
pack: 6



**08.00388**  
φιάλη νερού  
«Optima»  
water bottle, 0,75 lt  
8 cm | 26 cm  
(καπάκι | lid: 08.00393)  
pack: 6





## ποτήρια polycarbonate

	97.12361 TB.07 tumbler frosted 24 cl (6,7 cm   10,2 cm) pack: 350
	97.10230 TB.30 tumbler frosted 35 cl (7,5 cm   11,7 cm) pack: 240
	97.10237 EC.35 tumbler 35 cl (7,5 cm   11,6 cm) pack: 200
	97.10229 T.284 ποτήρι μπίρας beer glass 28,4 cl (7,2 cm   11,8 cm) pack: 140
	97.12384 T.568 tulip 56,8 cl (8,8 cm   16 cm) pack: 70
	97.10235 P.M.B34 ποτήρι μπίρας beer glass 34 cl (6,7 cm   14,3 cm) pack: 48

## κανάτες / καράφες | decanters / pitchers / jugs

	30.40267 κανάτα πλαστική με εσωτερικό δοχείο πάγου και καπάκι plastic jug with internal ice insert and lid 3 lt 15 cm   29 cm pack: 1		92.00858 κανάτα PC   pitcher 1,8 lt 18,7 cm   20 cm pack: 6
	30.41299 κανάτα πλαστική με εσωτερικό δοχείο πάγου και καπάκι plastic jug with internal ice insert and lid 2,2 lt 15 cm   26 cm pack: 1		30.41315 κανάτα PC άθραυστη pitcher break resistant 8 lt 12,5 cm   21 cm pack: 1
	92.00857 κανάτα PC με καπάκι with lid 1,9 lt 18,5 cm   24,8 cm pack: 6		καράφες πλαστικές plastic bottles 27.10772 μπλε καπάκι   blue lid 1,6 lt 11 cm   30 cm pack: 1 27.10773 πορτοκαλί καπάκι orange lid 1,6 lt 11 cm   30 cm pack: 1
	30.40279 κανάτα πλαστική με καπάκι plastic jug with lid 2 lt 12 cm   25 cm pack: 1		30.40268 καράφα πλαστική plastic bottle 1 lt 9,2 cm   24,5 cm pack: 6



	97.10214 PMS23 tumbler «Avanos» 23 cl (7,6 cm   8,1 cm) pack: 200		97.10192 PM.W23 ποτήρι κρασιού <i>wine glass</i> 23 cl (7,4 cm   16,8 cm) pack: 60		 97.13302 PM.W23-PC002 ποτήρι κρασιού λευκό <i>wine glass white</i> 23 cl (7,4 cm   16,8 cm) pack: 60
	97.10218 PMS29 tumbler «Avanos» 29 cl (8,3 cm   9 cm) pack: 140		97.10197 PM.W32 ποτήρι κρασιού <i>wine glass</i> 32 cl (8,2 cm   18,5 cm) pack: 50		 97.13301 PM.W32-PC002 ποτήρι κρασιού λευκό <i>wine glass white</i> 32 cl (8,5 cm   18,5 cm) pack: 50
	97.12081 PMS33 tumbler «Avanos» 33 cl (7,6 cm   12,3 cm) pack: 140		 97.13300 PM.W48 cocktail clear 48 cl (8,5 cm   22 cm) pack: 40		 97.13303 PM.W48-PC002 cocktail λευκό white 48 cl (8,5 cm   22 cm) pack: 40
	97.10198 PMS45 tumbler «Avanos» 45 cl (8,4 cm   13,5 cm) pack: 80		97.10191 PM.C18 ποτήρι σαμπάνιας <i>champagne glass</i> 18 cl (5 cm   18 cm) pack: 24		97.13021 PM.C18-PC002 champagne white 18 cl (5,5 cm   21,8 cm) pack: 24
	97.13018 PMS29F tumbler «Avanos» frosted 29 cl (8,3 cm   9 cm) pack: 140		97.10225 PM.M28 ποτήρι μαρτίνι <i>martini glass</i> 23,6 cl (11,5 cm   16,6 cm) pack: 48		
	97.10204 PMS33F tumbler «Avanos» frosted 33 cl (7,6 cm   12,3 cm) pack: 140		97.10228 PM.M30 ποτήρι μαργαρίτας <i>margarita glass</i> 35 cl (11,8 cm   17,5 cm) pack: 48		
	97.12076 PM.400F tumbler «Avanos» frosted 40 cl (8,5 cm   13,5 cm) pack: 60		97.10188 PM.D42 ποτήρι επιδορπίου <i>ice cream glass</i> 23 cl (10,3 cm   7,3 cm) pack: 50		
	97.10205 PMS45F tumbler «Avanos» frosted 45 cl (8,4 cm   13,5 cm) pack: 80				
	97.13017 RCB25F tumbler «Casablanca» frosted 25 cl (8,2 cm   9 cm) pack: 120				
	97.13019 RCB30F tumbler «Casablanca» frosted 30 cl (7,5 cm   11,9 cm) pack: 100				
	97.13020 RCB40F tumbler «Casablanca» frosted 40 cl (8,2 cm   13,3 cm)				



# STREETFOOD GO

Όταν το σερβίρισμα εκτελείται κάτω από απαιτητικές συνθήκες (χώρος, χρόνος, ποδοκοσμία, στην πισίνα) τότε το απίχτιο σημαίνει μεγάλο πρόβλημα και όχι μόνο οικονομικό. Η σειρά street food από μελαμίνη σας δικαιώνει αμέτρητες φορές για την επιλογή σας. Προκαλεί μόνο τις αισθήσεις σας.

When servicing food is performed under demanding conditions such as space, time, crowded place, outside by the waterpool then an accident creates enormous problem and it is not just an economic one. The street food line from melamine justifies countless times your choice of selecting it.



**30.80414**  
μπολ | bowl  
assorted colours  
8x7 cm | 4,5 cm  
pack: 12/96



**30.80411**  
πίατο | plate  
assorted colours  
20x16 cm  
pack: 6/48



**30.80415**  
μπολ | bowl  
assorted colours  
10,5x7,5 cm | 5,5 cm  
pack: 12/72



**30.80413**  
πίατο | plate  
assorted colours  
27,5x23 cm  
pack: 6/24







**30.80410**  
μπολ | bowl  
assorted colours  
16 cm | 9,5 cm  
pack: 6/48



**30.80412**  
πίατο βαθύ | deep plate  
assorted colours  
19,5x16 cm  
pack: 6/48

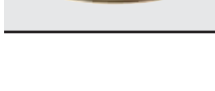

## «Stone Art» μελαμίνες

	<b>27.84523</b> μπολ   bowl, 7 cl 8 cm   3 cm pack: 1
	<b>*27.84524</b> μπολ   bowl, 30 cl 12 cm   6 cm pack: 1
	<b>27.84525</b> μπολ   bowl, 60 cl 15 cm   7,5 cm pack: 1
	<b>*27.84509</b> μπολ   bowl, 15 cl 15,5 cm   2,5 cm pack: 1
	<b>*27.84514</b> μπολ   bowl, 60 cl 20 cm   4,5 cm pack: 1
	<b>27.84526</b> μπολ οβάλ   bowl, 60 cl 23x19 cm   6,5 cm pack: 1
	<b>27.84528</b> μπολ οβάλ   bowl, 1,2 lt 28,5x21 cm   7,5 cm pack: 1
	<b>πίατο ρηχό   plate</b> <b>*27.84510</b> 19 cm   2 cm pack: 1
	<b>*27.84511</b> 25 cm   2 cm pack: 1
	<b>*27.84512</b> 30 cm   2 cm pack: 1



APS

μεδαμίνες «Stone Art»



\*27.84515  
πίατο βαθύ | *deep plate*  
24,5 | 3,5 cm  
pack: 1



\*27.84529  
μπολ | *bowl*, 0,5 lt  
19x19 cm | 6 cm  
pack: 1



\*27.84530  
μπολ | *bowl*, 1,1 lt  
24x24 cm | 6,5 cm  
pack: 1



\*27.84517  
δίσκος | *tray*  
33x32,5 cm | 3 cm  
pack: 1



\*27.84519  
δίσκος | *tray*,  
GN 1/1  
53x32,5 cm | 1,5 cm  
pack: 1



\*27.84520  
δίσκος | *tray*,  
GN 1/2  
32,5x26,5 cm | 1,5 cm  
pack: 1



\*27.84521  
δίσκος | *tray*,  
GN 1/3  
32,5x17,6 cm | 1,5 cm  
pack: 1



\*27.84522  
δίσκος | *tray*,  
GN 2/4  
53x16,2 cm | 1,5 cm  
pack: 1

MORI2A

ποτήρια polycarbonate



ποτήρια PC «Granity»  
40 cl  
9 cm | 10,6 cm

05.90002  
διάφανο | *transparent*  
pack: 12



05.90004  
μαύρο | *black*  
pack: 12



05.90006  
λευκό | *white*  
pack: 12



05.90008  
φιμέ | *fume*  
pack: 12



05.90010  
οσινέ | *satin*  
pack: 12



ποτήρια PC «Granity»  
50 cl  
9 cm | 13,2 cm

05.90003  
διάφανο | *transparent*  
pack: 12



05.90005  
μαύρο | *black*  
pack: 12



05.90007  
λευκό | *white*  
pack: 12



05.90009  
φιμέ | *fume*  
pack: 12



05.90011  
οσινέ | *fume*  
pack: 12



ποτήρια PC «Drop line»  
38 cl  
9 cm | 10,2 cm

05.90014  
διάφανο | *transparent*  
pack: 12



05.90020  
μπλε | *blue*  
pack: 12



05.90018  
μωβ | *purple*  
pack: 12



05.90016  
πράσινο | *green*  
pack: 12



ποτήρια PC «Drop line»  
52 cl  
9 cm | 13 cm



05.90015  
διάφανο | *transparent*  
pack: 12



05.90021  
μπλε | *blue*  
pack: 12



05.90019  
μωβ | *purple*  
pack: 12



05.90017  
πράσινο | *green*  
pack: 12



μπολ PC «Drop line»  
12 cm | 7,5 cm



05.90022  
διάφανο | *transparent*  
pack: 12



05.90025  
μπλε | *blue*  
pack: 12



05.90024  
μωβ | *purple*  
pack: 12



05.90023  
πράσινο | *green*  
pack: 12



05.90013  
ποτήρι σαμπάνιας  
διάφανο PC  
*flute, transparent*  
18 cl  
7,4 cm | 20,7 cm  
pack: 12





**08.01026**  
καφετιέρα γυάλινη,  
μεταλλικό μαύρο φίλτρο, 1 lt  
*glass cafetiere with inox  
black mesh*  
16,5 cm | 18,8 cm  
pack: 6

*Lugli Borinioli*



*Lugli Borinioli*

**08.01027**  
τοαγιέρα γυάλινη,  
με καπάκι μπαμπού  
*glass tea pot  
with bamboo cover*  
1 lt  
18,6 cm | 15,4 cm  
pack: 6



*Lugli Borinioli*

**08.01028**  
σετ 2 γυάλινα βάζα  
ζάχαρης, 33 cl  
με καπάκι μπαμπού  
*set of 2 sugar pots  
with bamboo cover*  
9 cm | 10,3 cm  
pack: 12



PKS

**60.37052**  
καφετιέρα γυάλινη  
με ανοξείδωτη βάση  
*glass cafetiere with inox base*  
30 cl  
pack: 1/24

**60.37053**  
ανταλλακτικό γυαλί  
*spare part glass*  
pack: 1/24



PKS

**60.37057**  
καφετιέρα γυάλινη  
με ανοξείδωτη βάση  
*glass cafetiere with inox base*  
30 cl  
pack: 1/24

**60.37059**  
ανταλλακτικό γυαλί 30 cl  
*spare part glass 30 cl*  
pack: 1/30

**10.90088**  
φίλτρο τοαγιού  
*tea filter*  
4 cm | 15 cm  
pack: 1



GHIDINI  
ITALY

**30.71338**  
τοαγιέρα  
μαντεμένια μαύρη,  
με inox σουρωτήρι  
*teapot cast iron,  
with s.s. strainer, black*  
40 cl  
pack: 1



**30.71340**  
τοαγιέρα μαντεμένια  
μαύρη/χρυσή,  
με inox σουρωτήρι  
*teapot cast iron,  
with s.s. strainer,  
stripes gold, black*  
50 cl



# coffee-tea time



60.4040   
 mug πορσελάνης  
 σε 3 χρώματα  
 assorted |  
 porcelain mug,  
 3 assorted colors, 32,5 cl  
 pack: 12/48



60.4045   
 mug πορσελάνης  
 (λευκό, γκρι, μαύρο)  
 assorted |  
 porcelain mug,  
 (white, gray, black), 32,5 cl  
 pack: 12/48



60.40425   
 mug πορσελάνης  
 σε 4 χρώματα  
 assorted |  
 porcelain mug,  
 4 assorted colors, 32,5 cl  
 pack: 12/48



60.40290  
 mug fine stoneware  
 μαύρη | black, 35 cl  
 pack: 12/36



60.40291  
 mug fine stoneware  
 κόκκινη | red, 35 cl  
 pack: 12/36



60.40288  
 mug fine stoneware  
 λευκή | white, 35 cl  
 pack: 12/36



## fine stoneware *turnig handle*



60.40414  
 φλιτζάνι espresso  
 με πιάτο κόκκινο, 8 cl  
 pack: 6/72



60.40422  
 φλιτζάνι espresso  
 με πιάτο μπλε, 8 cl  
 pack: 6/72



60.40413  
 φλιτζάνι espresso  
 με πιάτο γκρι, 8 cl  
 pack: 6/72



60.40415  
 φλιτζάνι espresso  
 με πιάτο μαύρο, 8 cl  
 pack: 6/72

60.40417  
 φλιτζάνι cappuccino  
 με πιάτο κόκκινο, 24 cl  
 pack: 6/36

60.40423  
 φλιτζάνι cappuccino  
 με πιάτο μπλε, 24 cl  
 pack: 6/36

60.40416  
 φλιτζάνι cappuccino  
 με πιάτο γκρι, 24 cl  
 pack: 6/36

60.40418  
 φλιτζάνι cappuccino  
 με πιάτο μαύρο, 24 cl  
 pack: 6/36

60.40420  
 φλιτζάνι σοκολάτας  
 με πιάτο κόκκινο, 39 cl  
 pack: 6/24

60.40424  
 φλιτζάνι σοκολάτας  
 με πιάτο μπλε, 39 cl  
 pack: 6/24

60.40419  
 φλιτζάνι σοκολάτας  
 με πιάτο γκρι, 39 cl  
 pack: 6/24

60.40421  
 φλιτζάνι σοκολάτας  
 με πιάτο μαύρο, 39 cl  
 pack: 6/24

## Duos

*Luigi Bormioli*



08.00119  
espresso, 12 cl  
σετ 2 τμχ.  
7 cm | 8 cm  
pack: 12



08.00118  
καφέ, 29,5 cl  
σετ 2 τμχ.  
8,6 cm | 11,3 cm  
pack: 12



08.00117  
multipurpose, 38,5 cl  
σετ 2 τμχ.  
11,8 cm | 8 cm  
pack: 12

## Sublime thermic

*Luigi Bormioli*



08.01039  
espresso (σετ 2 τμχ.)  
8,5 cl  
8,2 cm | 5,9 cm  
pack: 1



08.01038  
cappuccino (σετ 2 τμχ.)  
24 cl  
11 cm | 7,9 cm  
pack: 1



08.01040  
multipurpose (σετ 2 τμχ.)  
38 cl  
12,4 cm | 8,3 cm  
pack: 1



08.01037  
mug (σετ 2 τμχ.)  
35 cl  
11,2 cm | 10,6 cm  
pack: 1



08.01035  
beverage (σετ 2 τμχ.)  
40 cl  
8 cm | 13 cm  
pack: 1



08.01036  
d.o.f (σετ 2 τμχ.)  
37 cl  
8,8 cm | 10 cm  
pack: 1

## Thermic glass

*Luigi Bormioli*



08.00115  
thermic tumbler, 47 cl  
σετ 2 τμχ.  
9 cm | 15 cm  
pack: 1/12



08.00116  
thermic tumbler, 35 cl  
σετ 2 τμχ.  
9 cm | 11,5 cm  
pack: 1/12



08.00359  
latte macchiato, 34 cl  
σετ 2 τμχ.  
9 cm | 15 cm  
pack: 1/12

## Thermic glass

*Luigi Bormioli*



08.00283  
espresso, 6,5 cl  
με ίνoχ πιατάκι  
σετ 2 τμχ.  
pack: 1



08.00284  
cappuccino, 16,5 cl  
με ίνoχ πιατάκι  
σετ 2 τμχ.  
pack: 1



08.00285  
multipurpose, 30 cl  
με ίνoχ πιατάκι  
σετ 2 τμχ.  
pack: 1

## Easy bar



00.11187  
espresso, 10 cl  
pack: 12



00.11188  
πιατάκι espresso  
pack: 6/72



00.11183  
cappuccino, 23 cl  
pack: 12



00.11184  
πιατάκι cappuccino  
pack: 6/72

00.11185  
τσαγιού, 32 cl  
pack: 12

00.11186  
πιατάκι τσαγιού  
pack: 6/72



## Kaleido



00.11189  
espresso, 10 cl  
6,2 cm | 6,4 cm  
pack: 6/48



00.11188  
πιατάκι espresso  
pack: 6/72



00.11190  
cappuccino, 23 cl  
pack: 12



00.11184  
πιατάκι cappuccino  
pack: 6/72

00.11191  
τσαγιού, 32 cl  
pack: 12

00.11186  
πιατάκι τσαγιού  
pack: 6/72

## Conic



01.38002  
espresso, 8 cl  
6,5 cm | 5,7 cm  
pack: 24



01.55032  
πιατάκι, 11,8 cm  
pack: 48

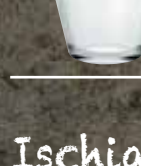

01.38003  
cappuccino, 28 cl  
9,5 cm | 8,4 cm  
pack: 6



01.55031  
πιατάκι, 15 cm  
pack: 36

## Ischia



01.55033  
espresso, 8 cl  
6,4 cm | 5,7 cm  
pack: 6



01.55032  
πιατάκι espresso  
15 cm  
pack: 48



01.55034  
cappuccino, 18 cl  
8,2 cm | 7,4 cm  
pack: 6

01.55031  
πιατάκι cappuccino  
18 cm  
pack: 6/72



## Sentido

οπίς



40.00011  
espresso, 9 cl  
7,5 cm | 5,1 cm  
pack: 6



40.00012  
cappuccino, 22 cl  
8,9 cm | 7,2 cm  
pack: 6



40.00013  
americano, 37 cl  
11,1 cm | 8,6 cm  
pack: 6



40.00014  
irish coffee, 26 cl  
14,3 cm | 6,8 cm  
pack: 6



οπίς

## Bill

40.00010  
«Bill», 24 cl  
7,7 cm | 14,6 cm  
pack: 12



40.00009  
«Mini Bill», 12 cl  
8,3 cm | 11 cm  
pack: 12

οπίς

## Acapulco



40.00226  
late, 28 cl  
7,8 cm | 15 cm  
pack: 6



37.02609  
cappuccino, 18 cl  
7,5 cm | 8 cm  
pack: 6



37.02783  
espresso, 8 cl  
5,8 cm | 6,5 cm  
pack: 6

## Elba



Borghonovo

01.38042  
φλιτζάνι καφέ, 28 cl  
7,7 cm | 14,5 cm  
pack: 6

## Conic



Borghonovo

01.38046  
φλιτζάνι καφέ, 31 cl  
8,3 cm | 10,2 cm  
pack: 6

## Americano





Ocean

70.10153  
mug, 35,5 cl  
8,9 cm | 11 cm  
pack: 6/48

# coffee-tea time



## «Executive»

	<b>ΡΗΝΙΤΣΟΧ</b> καφετιέρες inox   <i>coffee pots</i> *19.37154 0,5 lt pack: 1 *19.37155 0,75 lt pack: 1 *19.37156 1 lt pack: 1
	<b>ΡΗΝΙΤΣΟΧ</b> τοαγιέρες inox   <i>tea pots</i> *19.37157 0,5 lt pack: 1 *19.37158 0,75 lt pack: 1
	<b>ΡΗΝΙΤΣΟΧ</b> γαλατιέρες inox   <i>milk pots</i> *19.37150 0,15 lt pack: 1 *19.37151 0,25 lt pack: 1 *19.37152 0,5 lt pack: 1 *19.37153 0,75 lt pack: 1

## καφετιέρες/τοαγιέρες | *coffee/tea pots*

	<b>HENDI</b> καφετιέρες/τοαγιέρες inox <i>coffee/tea pots</i> 30.40131 0,3 lt (7,4 cm   9,5 cm) pack: 1 30.40132 0,5 lt (7,4 cm   12,3 cm) pack: 1 30.40133 1 lt (9,7 cm   14,2 cm) pack: 1 30.41316 2 lt (12,6 cm   18,5 cm) pack: 1
---	---

## καφετιέρες espresso | *espresso makers*

	<b>GHIDINI ITALY</b> καφετιέρες espresso αλουμινίου 3 φλιτζανιών <i>aluminium espresso makers, 3 cups</i> 10.40327 καφετιέρα πορτοκαλί <i>orange espresso maker</i> pack: 1/6 10.40328 καφετιέρα μαύρη <i>black espresso maker</i> pack: 1/6 10.40329 καφετιέρα <i>espresso maker</i> pack: 1/6 10.40339 καφετιέρα <i>espresso maker</i> pack: 1/6
---	---



για φλιτζάνια καφέ, καφετιέρες  
και τοαγιέρες πορσελάνης  
ανατρέξτε

σελίδες **8-121**  
ΠΟΡΣΕΛΑΝΕΣ

## θήκες τοαγιού/ζάχαρης | *tea/sugar box*



ξύλινο κουτί για φακελάκια 12 θέσεων  
*wooden tea-box with 12 chambers*

27.11775 31x28 cm | 9 cm  
pack: 1/24



κουτί μελαμίνης με χωρίσματα  
*melamine shape sorter with 3 removable  
dividers*

27.84531 λευκό | *white*  
31,5x17,5 cm | 7 cm  
pack: 1



27.84532 γκρι | *grey*  
31,5x17,5 cm | 7 cm  
pack: 1

## διανεμτές | *shakers*



30.40885 κανελιέρα inox  
με σίτα inox  
*mesh top shaker*  
5,5 cm | 7,5 cm  
pack: 1



27.00781 κανελιέρα γυάλινη  
με σίτα inox  
*mesh top shaker*  
6,5 cm | 12 cm  
pack: 1



27.00782 διανεμτής γυάλινος  
με τρύπες 2 mm  
*glass shaker with 2 mm holes*  
6,5 cm | 12 cm  
pack: 1



27.00783 διανεμτής γυάλινος  
με τρύπες 8 mm  
*glass shaker with 8 mm holes*  
6,5 cm | 12 cm  
pack: 1



κανάτες θερμός  
με καπάκι και λαβή χωρίς ραφές,  
πλένονται στο πλυντήριο πιάτων  
inox / chrome καπάκι και λαβή  
*double walled stainless steel Vacuum jugs with  
lid. Seamless body inox 18/10  
metal chrome cover and handle.  
Dishwasher safe*

30.40125 0,6 lt  
12x17 cm  
pack: 1

30.40115 1 lt  
14x19 cm  
pack: 1

30.40126 1,5 lt  
14x26 cm  
pack: 1



κανάτες θερμός,  
*inox vacuum jugs*

30.40973 1 lt  
14,5 cm | 20 cm  
pack: 1/12

30.40974 1,5 lt  
14,5 cm | 23 cm  
pack: 1/12

30.40975 2 lt  
14,5 cm | 26 cm  
pack: 1/12



60.30056 κανάτα θερμός, inox  
διπλού τοιχώματος  
*vacuum jug*  
1,2 lt  
pack: 1/12



κανάτες θερμός, PP/γυαλί  
*inox vacuum jugs, glass inner bottle*

30.40271 μαύρη | *black*, 1 lt  
14 cm | 26,8 cm  
pack: 1/12



κανάτες θερμός, PP/γυαλί  
*inox vacuum jugs, glass inner bottle*

27.10914 μαύρη | *black*, 1 lt  
16 cm | 20 cm  
pack: 1

27.10913 λευκή | *white*, 1 lt  
16 cm | 20 cm  
pack: 1



30.40273 air pot, inox, 3 lt  
διπλού τοιχώματος  
περιοτρέφεται στη βάση του  
*double walled  
with turning base*  
17,1 cm | 37,3 cm  
pack: 1



30.40275 air pot, inox  
διπλού τοιχώματος  
*double walled*  
2,2 lt  
15 cm | 34 cm  
pack: 1



## Ζαχαριέρες-γαλατιέρες | *sugar accessories*

	<p>Ζαχαριέρα inox, με δύο κουτάλια <i>inox sugar bowl with 2 spoons</i></p> <p>*19.25011 14 cm pack: 1</p>		<p>GenWare</p> <p>γαλατιέρες αντικολητικές <i>non-stick milk jugs, 15 cl</i></p> <p>34.60376 μαύρη   <i>black</i> pack: 1</p>
	<p>*27.00765 διανεμητής γυάλινος, inox καπάκι, για μέλι, γάλα, κ.λπ. <i>dispenser, glass/inox</i> <i>for honey, cream, etc.</i></p> <p>30 cl 8,5 cm   13,5 cm pack: 1</p>		<p>34.60378 κόκκινη   <i>red</i> pack: 1</p> <p>34.60377 καφέ   <i>brown</i> pack: 1</p>
	<p>30.40067 ζαχαριέρα γυάλινη, inox καπάκι <i>sugar dispenser, glass/inox</i></p> <p>20 cl 8 cm   14 cm pack: 1</p>		<p>GÜRAL PORSELEN</p> <p>52.27025 γαλατιέρα πορσελάνης <i>porcelain creamer</i> 12,5 cl pack: 6</p>
	<p>30.40068 μελιέρα γυάλινη, inox καπάκι <i>honey dispenser, glass/inox</i></p> <p>8 cm   11,5 cm pack: 1</p>		<p>GÜRAL PORSELEN</p> <p>52.84013 γαλατιέρα πορσελάνης <i>porcelain creamer</i> 9 cl pack: 6</p>
	<p>Ζαχαριέρες inox   <i>inox sugar dispensers</i></p> <p>60.25016 4 cm   13 cm pack: 1/12</p> <p>60.25015 4 cm   16 cm pack: 1/12</p>		<p>HENDI</p> <p>σετ 2 λαβίδες ζάχαρης inox <i>set of 2 inox sugar tongs</i></p> <p>30.41059 16 cm pack: 1</p>
	<p>19.50559 ζαχαριέρα inox <i>inox sugar tray</i> 10,5x5,5 cm pack: 1</p>		<p>HENDI</p> <p>96.31008 λαβίδα ζάχαρης inox <i>inox sugar tong</i> 14 cm pack: 1</p>
	<p>52.33073 ζαχαριέρα πορσελάνης <i>porcelain sugar bowl</i> 12 cm pack: 1</p>		<p>96.31000 λαβίδα ζάχαρης inox <i>inox sugar tong</i> 12 cm pack: 1</p>
	<p>GÜRAL PORSELEN</p> <p>52.33072 ζαχαριέρα πορσελάνης <i>porcelain sugar bowl</i> 12 cm pack: 12</p>		<p>σουβέρ, inox   <i>coaster inox</i></p> <p>96.31011 10 cm pack: 6</p>
	<p>GÜRAL PORSELEN</p> <p>52.33074 ζαχαριέρα πορσελάνης <i>porcelain sugar bowl</i> 12 cm pack: 12</p>		

## σιφόν αλουμινίου «Kitchen Line» cream

HENDI



σιφόν αλουμινίου με νέα θήκη αμπούλας από αλουμίνιο! Παραδίδονται με 3 λευκά στόμια PP και βουρτσάκι καθαρισμού. Πλένονται στο πλυντήριο.

*aluminium cream whippers with 3 polypropylene nozzles and cleaning brush, washing machine safe.*

30.40129 λευκό | white, 0,5 lt  
8 cm | 26 cm  
pack: 1

30.40120 λευκό | white, 1 lt  
9,5 cm | 32 cm  
pack: 1

σιφόν αλουμινίου με νέα θήκη αμπούλας από αλουμίνιο! Παραδίδονται με 3 μαύρα στόμια PP και βουρτσάκι καθαρισμού. Πλένονται στο πλυντήριο.

*aluminium cream whippers with 3 polypropylene nozzles and cleaning brush, washing machine safe.*

30.41588 μαύρο | black, 0,5 lt  
8 cm | 26 cm  
pack: 1

30.40123 σετ ανταλλακτικών 3 στόμια PP, βουρτσάκι καθαρισμού, ροδέλα, βαλβίδα ασφαλείας, συγκρατητής αμπούλας  
*set spare parts 3 nozzles PP, cleaning brush, washer (ring) safety valve, charger holder*  
pack: 1

HENDI

## σιφόν «Profi Line» cream whippers

Ιδανικά για παρασκευή σαντιγί, αφρόγαλα, μους, σάλτσες. Ιδανικά και για ζεστές κρέμες, σάλτσες. Τέλεια για γαρνίρισμα καφέ, shakes, παγωτών. Με 3 μύτες και βουρτσάκι καθαρισμού. Διατηρούν το περιεχόμενο έως 14 ημέρες.

*Makes delicious whipped cream, mousses, desserts, cold foams and sauces easily. Perfect for garnishing cappuccinos, coffees, shakes and ice cream. Suitable for dispensing warm creams and sauces up to 70°C. Keeps contents fresh for up to 14 days in the refrigerator. Includes 3 stainless steel nozzles and a cleaning brush.*

30.40893 0,5 lt  
8,5 cm | 23,5 cm  
pack: 1

30.40118 1 lt  
9,8 cm | 33 cm  
pack: 1

HENDI

HENDI



σετ για σιφόν σαντιγί Hendi. περιέχει 3 στόμια, θήκη αμπούλας, φλάντζες, βαλβίδα και βούρτσα καθαρισμού

*spare parts set for Hendi cream whippers contains 3 nozzles, cartridge holder, gaskets, valve and cleaning brush.*

30.40119 pack: 1

HENDI

## αμπούλες σιφόν | cream whipper chargers



30.40117 αμπούλες σιφόν 10 τμχ.  
*cream whipper chargers 10 pcs.*  
pack: 1

## θερμόμετρο γάλακτος | milk thermometer

HENDI



θερμόμετρο γάλακτος με κλιπ και ένδειξη ιδανικής θερμοκρασίας  
*milk thermometer with clip and green indicator for ideal milk temperature*

30.41218 inox, -10°C / +110°C  
pack: 1

## γαλατιέρες barista | barista milk jugs

HENDI



γαλατιέρες inox 18/10 milk jugs

30.41054 35 cl  
pack: 1

30.41055 60 cl  
pack: 1

30.41056 90 cl  
pack: 1

30.41057 1,5 lt  
pack: 1

HENDI



γαλατιέρες inox με στόμιο V milk jugs with V-shaped spout, inox

30.42203 35 cl  
pack: 1

30.42202 45 cl  
pack: 1

30.42201 70 lt  
pack: 1

HENDI



30.42204 γαλατιέρα inox μαύρη ματ, με στόμιο V milk jugs V-shaped, inox black matt coating 70 cl  
pack: 1

HENDI



30.41721 γαλατιέρα inox 18/10 μαύρη, αντικολλητική milk jugs, inox 18/10 black non-stick coating 60 cl  
pack: 1

GenWare



34.60078 γαλατιέρα αντικολλητική, κόκκινη non-stick milk jug, 60 cl  
pack: 12





εργαλεία barista | *barista tools*

	<p>knock box, GN inox/silicone</p> <p>30.41590 GN 1/6 17,6x16,2 cm   10 cm pack: 1</p> <p>30.41591 GN 1/4 26,5x16,2 cm   10 cm pack: 1</p>		<p>30.41595 δυναμομετρικό tamper <i>coffee tamper with spring</i> 5,8 cm   10,5 cm pack: 1</p>
	<p>knock box, GN inox/silicone με ξύλινο πλαίσιο   <i>in wooden frame</i></p> <p>30.41592 GN 1/4 27,5x17,5 cm   12 cm pack: 1</p>		<p>30.41596 ρυθμιζόμενο tamper <i>palm coffee tamper adjustable</i> 5,8 cm   3,5 cm pack: 1</p>
	<p>knock box, inox/silicone</p> <p>30.41593 στρογγυλό   <i>round</i> 15,3x18,5 cm   16,5 cm pack: 1</p>		<p>30.40277 tamper, 380 gr 5,8 cm   9,5 cm pack: 1</p>
	<p>knock box, carbon steel με συρτάρι και διάτρητη οροφή <i>with drawer perforated top</i></p> <p>30.41594 35x25 cm   9 cm pack: 1</p>		<p>30.41058 σετ 2 βουρτσάκια / <i>μεζούρες espresso</i> <i>set 2 brushes with measure</i> <i>spoon</i> pack: 1</p>
	<p>30.41598 λάστιχο tamper σιλικόνης <i>silicone tamping mat</i> 15x10 cm - 4,5 cm pack: 1</p>		
	<p>30.41597 λάστιχο tamper διπλό σιλικόνης <i>double silicone tamping mat</i> 20,5x15 cm - 4,5 cm pack: 1</p>		
	<p>30.41599 βάση tamper <i>tamping stand</i> 9,3x14,2 cm - 6 cm pack: 1</p>		

	<p>φραπιέρα από ABS          δύο ταχυτήτων 15.000 και 19.000 rpm          με 2 κύπελλα (inox &amp; PC),          2 σετ 2 αναδευτήρων  <i>milksbake mixer, ABS,          two speeds, 15.000 and 19.000 rpm          two mixing cups (inox &amp; PC)          two different agitators</i>          400W, 220-240V          17x19,6 cm   49 cm          pack: 1</p>
	<p>30.42135 κόκκινη   berry          pack: 1</p>
	<p>30.42131 μαύρη   black          pack: 1</p>
	<p>30.42133 caramel          pack: 1</p>
	<p>30.42132 λευκή   frost white          pack: 1</p>
	<p>30.42134 sunny yellow          pack: 1</p>

### ανταλλακτικά φραπιέρας

	<p>30.42137 ανταλλακτικό κύπελλο          inox για φραπιέρα  <i>stainless steel mixing cup for          milksbake mixer</i>          0,95 lt          11,3 cm   16 cm          pack: 1</p>
	<p>30.42138 ανταλλακτικό κύπελλο          polycarbonate          για φραπιέρα  <i>polycarbonate mixing cup for          milksbake mixer</i>          0,95 lt          11,6 cm   16,1 cm          pack: 1</p>
	<p>30.42139 σετ 2 ανταλλακτικοί          αναδευτήρες polycarbonate  <i>replacement polycarbonate          agitators, set 2 pcs</i>          3,2x2,7 cm   5 cm          pack: 1</p>

φραπιέρα | *milk shaker*  
 design by Robert Bronwasser



Διαθέσιμη σε 6 ελκυστικά χρώματα.  
 Φτιάξτε φρέντο καπουτσίνο, φραπέ  
 και φυσικά μιλκσεϊκ χωρίς κόπο.

**Εγγυάται το τέλειο αποτέλεσμα**  
 Με διακόπτη δύο ταχυτήτων στο επάνω  
 μέρος, εύκολα προσβάσιμο.  
 Με δύο διαφορετικούς αναδευτήρες  
 για να ελέγξετε την ανάδευση.

**Χρήση με απόλυτη ασφάλεια**  
 Εξοπλισμένη με μικροδιακόπτη, ώστε  
 να λειτουργεί μόνο όταν το κύπελλο  
 είναι σωστά τοποθετημένο.

**Πλήρες σετ**  
 Η συσκευασία περιλαμβάνει 2 κύπελλα  
 ανάμιξης inox και PC (0,95 λίτρα)  
 και 2 σετ 2 αναδευτήρων. Τα κύπελλα και οι  
 αναδευτήρες πλένονται στο πλυντήριο πιάτων.

**Ανώτερη ποιότητα κατασκευής,  
 με την υπογραφή της Hendi**  
 Ισχυρός κινητήρας 400W.  
 Δύο ταχύτητες, 15.000 και 19.000 στροφές ανά λεπτό.  
 Περιβλήμα κατασκευασμένο από πλαστικό ABS.  
 Στιβαρή βάση με ελαστικά πόδια για επιπλέον  
 σταθερότητα.

### ΕΓΓΥΗΣΗ 2 ΕΤΩΝ

Προδιαγραφές:  
 Υλικό: ABS  
 Ισχύς: 400W, 220-240V  
 Μήκος (mm): 170  
 Πλάτος (mm): 196  
 Ύψος (mm): 490  
 Συσκευασία κιβωτίου: 2



## μαγειρικά σκεύη

μαρμίτες, χύτρες, κατσαρόλες, τηγάνια, αντικολλητικά σκεύη .....382-392

## σκεύη φούρνου

ταψιά, δίσκοι ψησίματος, γκριλιέρες, επιφάνειες σιδικόννης .....393-394

## εργαλεία μαγειρικής - ζαχαροπλαστικής

μπολ ανάμιξης inox, polypropylene, μπασίνες .....395

σουρωτήρια / σινονά / κόσκινα / χωνιά .....396-397

σέσκουδες, μεζούρες, κουτάδες, πιρούνες, δαβίδες, σέσουδες, κουτάδες, πιρούνες, σπάτουδες, παδέτες .....398-405

εργαλεία πίσας .....406-409

σπάτουδες ζύμης, κόπτες, πλάστες, πινέδα, scoop .....410-411

αυγοδάριες .....412

επιφάνειες ψησίματος .....413

σακούδες και μύτες ζαχαροπλαστικής .....414-418

δοσομετριές (piston funnel) .....419

βάσεις και εργαλεία διακόσμησης, εργαλεία σοκολάτας .....420-421

τσέρκια, καδούπια .....422-428

φόρμες ψησίματος .....428-431

φόρμες σιδικόννης .....432-439

## μαχαίρια κουζίνας

μαχαίρια, μπάτες, μπατιάδες, πριόνια, μαγνήτες μαχαριών  
εργαλεία κρέατος, σούβδες .....440-453

## εργαλεία κουζίνας

εργαλεία ψαριού, ψαδίδια, γάντια .....454-455

δίκοι κοπής .....456-457

εργαλεία πάστας .....458

μαντοδίνα .....459

εργαλεία δαχανικών, μύδοι χορταρικών, τρίφιες .....460-465

ανοιχτήρια, εργαλεία αυγών - μανιταριών, γουδιά, oriental gadgets .....466-467

φιιάδες για σάιτσες .....468

ζυγαριές, χρονόμετρα .....469

θερμόμετρα .....470-471

δοχεία GN inox .....472-475

## παραλαβή - αποθήκευση

τρόδεϊ πλαιφόρμες, παδέτες .....477

ράφια .....478-479

δοχεία τροφίμων (polycarbonate, polypropylene) .....480-489

τρόδεϊ κουζίνας .....490-491

τρόδεϊ σεβριρίσματος πιάτων .....491

ισοθερμικά δοχεία μεταφοράς .....492-500

τρόδεϊ πιάτων .....501

καδάθια πλυντηρίων .....502-505



# *κουζίνα - kitchenware*

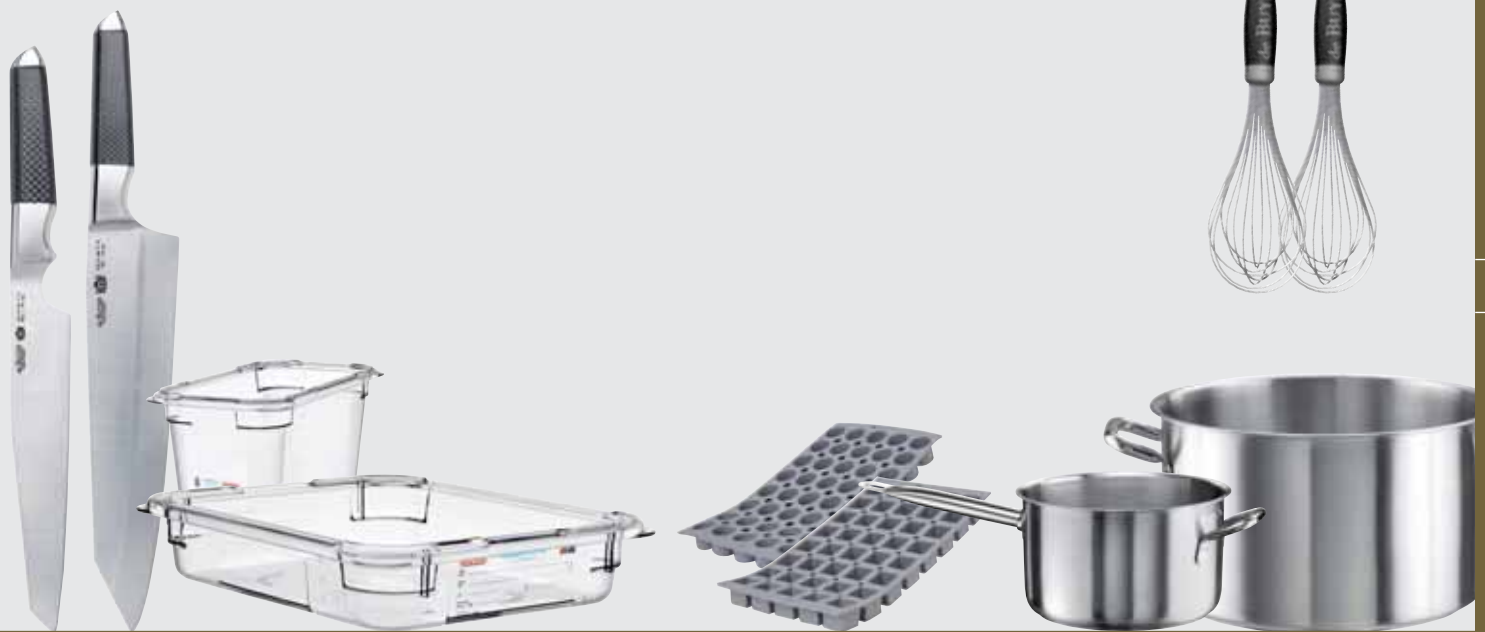

# «Master» 18/10



Τα σκεύη της σειράς Master της Pintinox, είναι η ιδανική λύση για την κουζίνα του επαγγελματία. Διαθέτει μεγάλη γκάμα σκευών. Κατάλληλα για όλες τις εστίες και induction. • Σύμα από ανοξείδωτο ατσάλι. • Σκεύη με διπλό ύψος και μεγάλη χωρητικότητα. • Τριπλή ενισχυμένη βάση (χάλυβας / αλουμίνιο / χάλυβας) με κωνικό καπάκι. • Επαγγελματική λαβή ενισχυμένη & εργονομική. • Ανοιχτό χείλος anti-drop. • Σατινέ φινιρίσμα.



The cookware line Master, Pintinox, is the perfect solution for professional use. Wide range of cookware. Compatible with all stovetops, including induction.

- Stainless steel body.
- Pots with double height and high capacity.
- Triple bottom (steel / aluminum / steel) with conical cap.
- Professional handle with reinforced flange.
- Rim for non-drip pouring.
- Elegant satin finish.

# PINTINOX

MADE IN ITALY

# MASTER

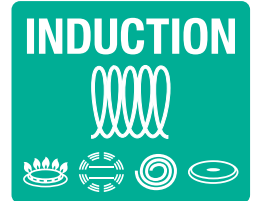

## μαρμίτα | stock pot



PINTINOX

### μαρμίτα | stock pot

- \*19.80198 2,9 lt (16 cm | 14,7 cm)  
pack: 1
- \*19.80199 4 lt (18 cm | 16 cm)  
pack: 1
- \*19.80200 5,5 lt (20 cm | 18 cm)  
pack: 1
- \*19.80201 7,2 lt (22 cm | 19 cm)  
pack: 1
- \*19.80202 10,7 lt (24 cm | 24 cm)  
pack: 1
- \*19.80203 17 lt (28 cm | 28 cm)  
pack: 1
- \*19.80204 21,2 lt (30 cm | 30 cm)  
pack: 1
- \*19.80205 25,7 lt (32 cm | 32 cm)  
pack: 1
- \*19.80206 30,7 lt (34 cm | 34 cm)  
pack: 1
- \*19.80207 36,5 lt (36 cm | 36 cm)  
pack: 1
- \*19.80208 50,2 lt (40 cm | 40 cm)  
pack: 1
- \*19.80209 63,5 lt (45 cm | 40 cm)  
pack: 1



## χύτρα ρηχή | medium pot



PINTINOX

### χύτρα ρηχή | medium pot

- \*19.80210 1,6 lt (16 cm | 8,5 cm)  
pack: 1
- \*19.80211 2,4 lt (18 cm | 9,5 cm)  
pack: 1
- \*19.80212 3,7 lt (20 cm | 12 cm)  
pack: 1
- \*19.80213 4,9 lt (22 cm | 13 cm)  
pack: 1
- \*19.80214 6,2 lt (24 cm | 14,5 cm)  
pack: 1
- \*19.80215 9,7 lt (28 cm | 16 cm)  
pack: 1
- \*19.80216 12 lt (30 cm | 17 cm)  
pack: 1
- \*19.80217 15,7 lt (32 cm | 19,5 cm)  
pack: 1
- \*19.80218 21,2 lt (36 cm | 21,5 cm)  
pack: 1
- \*19.80219 30 lt (40 cm | 24 cm)  
pack: 1
- \*19.80220 42,7 lt (45 cm | 27 cm)  
pack: 1
- \*19.80221 58,7 lt (50 cm | 30 cm)  
pack: 1



## χύτρα βαθιά | deep pot



PINTINOX

### χύτρα βαθιά | deep pot

- \*19.80192 2,5 lt (16 cm | 13 cm)  
pack: 1
- \*19.80193 3,5 lt (18 cm | 14,4 cm)  
pack: 1
- \*19.80194 4,9 lt (20 cm | 16 cm)  
pack: 1
- \*19.80195 6 lt (22 cm | 17,6 cm)  
pack: 1
- \*19.80196 8,4 lt (24 cm | 19,2 cm)  
pack: 1
- \*19.80197 15,5 lt (30 cm | 22,2 cm)  
pack: 1



## χύτρα σωτέ | shallow pot



PINTINOX

### χύτρα σωτέ | shallow pot

- \*19.80229 3,5 lt (24 cm | 8 cm)  
pack: 1
- \*19.80230 5,7 lt (28 cm | 9,5 cm)  
pack: 1
- \*19.80231 7 lt (30 cm | 10 cm)  
pack: 1
- \*19.80232 11 lt (32 cm | 11 cm)  
pack: 1
- \*19.80233 13 lt (36 cm | 13 cm)  
pack: 1
- \*19.80234 14,5 lt (40 cm | 14,5 cm)  
pack: 1
- \*19.80235 15,5 lt (45 cm | 15,5 cm)  
pack: 1
- \*19.80236 19 lt (50 cm | 19 cm)  
pack: 1





κατσαρόλα ρηχή | *medium saucepan*

  	κατσαρόλα βαθιά με χερούλι <i>deep saucepan with handle</i>
	*19.80237 1,2 lt (16 cm   6,5 cm) pack: 1
	*19.80238 2,2 lt (20 cm   7,5 cm) pack: 1
	*19.80239 3,5 lt (24 cm   8 cm) pack: 1
	*19.80240 5,7 lt (28 cm   9,5 cm) pack: 1
	*19.80241 11 lt (32 cm   11 cm) pack: 1

κατσαρόλα κωνική | *curved saute pan*

  	κατσαρόλα κωνική <i>curved saute pan</i>
	*19.80242 1 lt (16 cm   6,5 cm) pack: 1
	*19.80243 1,3 lt (18 cm   6,5 cm) pack: 1
	*19.8024 1,7 lt (20 cm   7 cm) pack: 1
	*19.80245 2,7 lt (24 cm   7,5 cm) pack: 1

κατσαρόλα βαθιά | *deep saucepan*

  	κατσαρόλα βαθιά   <i>deep saucepan</i>
	*19.80222 0,7 lt (12 cm   6,5 cm) pack: 1
	*19.80223 1,1 lt (14 cm   7,5 cm) pack: 1
	*19.80224 2 lt (16 cm   8,5 cm) pack: 1
	*19.80225 3,7 lt (20 cm   12 cm) pack: 1



κατσαρόλα βαθιά με χερούλι | *deep saucepan*

  	κατσαρόλα βαθιά με χερούλι <i>deep saucepan with handle</i>
	*19.80226 6,2 lt (24 cm   14,5 cm) pack: 1
	*19.80227 9,7 lt (28 cm   16 cm) pack: 1
	*19.80228 15,7 lt (32 cm   19,5 cm) pack: 1

κατσαρόλα κωνική με στόμιο  
*curved saute pan with pouring edge*

  	κατσαρόλα κωνική με στόμιο <i>curved saute pan with pouring edge</i>
	*19.80276 10 cm   5 cm pack: 1
	*19.80277 12 cm   5,5 cm pack: 1
	*19.80278 14 cm   6,5 cm pack: 1
	*19.80279 16 cm   6,5 cm pack: 1
	*19.80280 19 cm   6,5 cm pack: 1

τηγάνι | *frying pan*

  	τηγάνι   <i>frying pan</i>
	*19.80255 24 cm   5 cm pack: 1
	*19.80256 28 cm   5,7 cm pack: 1



τηγάνι με χερούλι | *frying pan with handle*

  	τηγάνι με χερούλι   <i>frying pan</i>
	*19.80257 30 cm   6 cm pack: 1
	*19.80258 32 cm   6 cm pack: 1
	*19.80259 34 cm   6,2 cm pack: 1
	*19.80260 36 cm   7 cm pack: 1
	*19.80261 40 cm   7,2 cm pack: 1
	*19.80262 45 cm   8 cm pack: 1

τηγάνι με 2 χερούλια | *frying pan with 2 handles*

  	τηγάνι με 2 χερούλια <i>frying pan with 2 handles</i>
	*19.80246 24 cm   5 cm pack: 1
	*19.80247 28 cm   5,7 cm pack: 1
	*19.80248 30 cm   6 cm pack: 1
	*19.80249 32 cm   6 cm pack: 1
	*19.80250 34 cm   6,2 cm pack: 1
	*19.80251 36 cm   7 cm pack: 1
	*19.80252 40 cm   7,2 cm pack: 1
	*19.80253 45 cm   8 cm pack: 1
	*19.80254 50 cm   9 cm pack: 1

wok

  	τηγάνι wok   <i>wok</i>
	*19.80281 30 cm   10 cm pack: 1

καπάκι | *lid*

 	καπάκι   <i>lid</i>
	19.80266 12 cm pack: 1
	*19.80267 14 cm pack: 1
	*19.80263 16 cm pack: 1
	*19.80264 18 cm pack: 1
	*19.80265 20 cm pack: 1
	*19.80268 28 cm pack: 1
	*19.80269 30 cm pack: 1
	*19.80270 32 cm pack: 1
	*19.80271 34 cm pack: 1
	*19.80272 36 cm pack: 1
	*19.80273 40 cm pack: 1
	*19.80274 45 cm pack: 1
	*19.80275 50 cm pack: 1

## «Profi line»

HENDI

Η επαγγελματική σειρά που διαθέτει όλα τα χαρακτηριστικά που έχουν ανάγκη οι ειδικοί των επαγγελματιών χύρων εστίασης. **Σύμα:** γυάλισμα satin που μένει, εξαιρετική αντοχή με ενισχυμένο γυαλιστερό χείδος.

• **Λαβές:** εργονομικές, συμπαγείς, δεν υπερθεμαίνονται. • **Πάτος:** τύπου sandwich, inox-αλουμίνιο-inox, οδικής διασποράς θερμότητας, καιάλθηδος και για εστίες induction. • **Καπάκι:** πάχους 1 mm με τρύπες για να διαφεύγει ο ατμός.



Durable and long lasting body satin finish and base. • Solid handles with multi-point fixing to the pot surface which don't get hot. • Sandwich type bottom (stainless steel/aluminium/stainless steel). • All lids are made of 1 mm stainless steel with steam release holes.



**HACCP**

ανοξείδωτο  
ατσάλι 304

αλουμίνιο  
5mm

ανοξείδωτο ατσάλι 430  
ελάχιστο πάχος: 0,5mm



### χύτρα βαθιά με καπάκι | deep pot with lid

HENDI	Κωδικός	Περιγραφή
	30.40559	χύτρα βαθιά   deep pot 2 lt (16 cm   11 cm) pack: 1
	30.40560	χύτρα βαθιά   deep pot 4 lt (20 cm   13 cm) pack: 1
	30.40561	χύτρα βαθιά   deep pot 7 lt (24 cm   15 cm) pack: 1
	30.40562	χύτρα βαθιά   deep pot 10 lt (28 cm   17 cm) pack: 1
	30.40563	χύτρα βαθιά   deep pot 15 lt (32 cm   19 cm) pack: 1
	30.40564	χύτρα βαθιά   deep pot 23,5 lt (36 cm   23 cm) pack: 1

### χύτρα ρηχή με καπάκι | medium pot with lid

HENDI	Κωδικός	Περιγραφή
	30.40552	χύτρα ρηχή   medium pot 1,5 lt (16 cm   7,5 cm) pack: 1
	30.40553	χύτρα ρηχή   medium pot 2,8 lt (20 cm   9 cm) pack: 1
	30.40554	χύτρα ρηχή   medium pot 4,8 lt (24 cm   10,5 cm) pack: 1
	30.40555	χύτρα ρηχή   medium pot 7,5 lt (28 cm   12 cm) pack: 1
	30.40556	χύτρα ρηχή   medium pot 12 lt (32 cm   15 cm) pack: 1



οπές  
διαφυγής  
υδρατμών





λαβές  
που δεν  
θερμαίνονται



κατσαρόλα σωτέ κωνική  
χωρίς καπάκι



*curved saute pan*  
without lid

	30.40557	κατσαρόλα κωνική <i>curved saute pan</i> 0,9 lt (16 cm   6 cm) pack: 1
	30.40558	κατσαρόλα κωνική <i>curved saute pan</i> 1,5 lt (20 cm   6 cm) pack: 1

μαρμίτα με καπάκι | *high pot with lid*



	30.40565	μαρμίτα   <i>high pot</i> 3 lt (16 cm   15 cm) pack: 1
	30.40566	μαρμίτα   <i>high pot</i> 6 lt (20 cm   19 cm) pack: 1
	30.40567	μαρμίτα   <i>high pot</i> 10 lt (24 cm   22 cm) pack: 1
	30.40568	μαρμίτα   <i>high pot</i> 16 lt (28 cm   26 cm) pack: 1
	30.40569	μαρμίτα   <i>high pot</i> 24 lt (32 cm   30 cm) pack: 1
	30.40570	μαρμίτα   <i>high pot</i> 37 lt (36 cm   36 cm) pack: 1
	30.40571	μαρμίτα   <i>high pot</i> 50 lt (40 cm   40 cm) pack: 1

τηγάνι χωρίς καπάκι | *frying pan without lid*

	30.40575	τηγάνι   <i>frying pan</i> 24 cm   4,5 cm pack: 1
	30.40576	τηγάνι   <i>frying pan</i> 28 cm   5 cm pack: 1
	30.40577	τηγάνι   <i>frying pan</i> 32 cm   5,5 cm pack: 1

τηγάνι αντικολλητικό  
χωρίς καπάκι

*frying pan non-stick*  
without lid

	*30.40572	τηγάνι αντικολλητικό <i>frying pan non-stick</i> 24 cm   4,5 cm pack: 1
	*30.40573	τηγάνι αντικολλητικό <i>frying pan non-stick</i> 28 cm   5 cm pack: 1
	*30.40574	τηγάνι αντικολλητικό <i>frying pan non-stick</i> 32 cm   5,5 cm pack: 1

κατσαρόλα χωρίς καπάκι | *saucepan without lid*

	30.40548	κατσαρόλα   <i>saucepan</i> 1,2 lt - 14 cm   7 cm pack: 1
	30.40549	κατσαρόλα   <i>saucepan</i> 1,5 lt - 16 cm   7,5 cm pack: 1
	30.40550	κατσαρόλα   <i>saucepan</i> 2 lt - 18 cm   8 cm pack: 1
	30.40551	κατσαρόλα   <i>saucepan</i> 3 lt - 20 cm   9 cm pack: 1





Το σκεύος των καιρών μας. Ανταγωνιστικό σε όλους τους τομείς: τεχνικές προδιαγραφές, εύρος γκάμας, ταχύτητα, αποδοτικότητα, σιάνιαρ υγιεινής, τιμή. Κατάλληλο για όλες τις εστίες και induction.

The cookware line of our times. Competitive in technical specifications, vast range, speed, efficiency, hygiene standards, price. Suitable for induction.

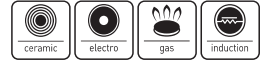

## χύτρα ρηχή | medium pot

	*53.20022	χύτρα ρηχή   medium pot 2 lt (18 cm   8 cm) pack: 1
	*53.20023	χύτρα ρηχή   medium pot 2,5 lt (20 cm   9 cm) pack: 1
	53.20024	χύτρα ρηχή   medium pot 4,5 lt (24 cm   10,5 cm) pack: 1
	53.20025	χύτρα ρηχή   medium pot 7 lt (28 cm   12 cm) pack: 1
	53.20026	χύτρα ρηχή   medium pot 10 lt (32 cm   13 cm) pack: 1
	53.20027	χύτρα ρηχή   medium pot 14 lt (36 cm   14 cm) pack: 1
	53.20028	χύτρα ρηχή   medium pot 20 lt (40 cm   16 cm) pack: 1
	53.20029	χύτρα ρηχή   medium pot 30 lt (44 cm   20 cm) pack: 1
	53.20030	χύτρα ρηχή   medium pot 41,5 lt (48 cm   23 cm) pack: 1

οι διαστάσεις αναφέρονται στο εσωτερικό των σκευών

## χύτρα βαθιά | deep pot

	53.20013	χύτρα βαθιά   deep pot 3 lt (18 cm   12 cm) pack: 1
	53.20014	χύτρα βαθιά   deep pot 4 lt (20 cm   13 cm) pack: 1
	53.20015	χύτρα βαθιά   deep pot 6,5 lt (24 cm   15 cm) pack: 1
	53.20016	χύτρα βαθιά   deep pot 10 lt (28 cm   17 cm) pack: 1
	53.20017	χύτρα βαθιά   deep pot 14 lt (32 cm   18 cm) pack: 1
	53.20018	χύτρα βαθιά   deep pot 23 lt (36 cm   23 cm) pack: 1
	53.20019	χύτρα βαθιά   deep pot 31 lt (40 cm   25 cm) pack: 1
	53.20020	χύτρα βαθιά   deep pot 42,5 lt (44 cm   28 cm) pack: 1
	53.20021	χύτρα βαθιά   deep pot 56 lt (48 cm   31 cm) pack: 1

οι διαστάσεις αναφέρονται στο εσωτερικό των σκευών

## μαρμίτα | stock pots

	53.20001	μαρμίτα   stock pot 10,7 lt (24 cm   24 cm) pack: 1
	53.20002	μαρμ. κοντή   low stock pot 14 lt (28 cm   23 cm) pack: 1
	53.20003	μαρμίτα   high pot 17 lt (28 cm   28 cm) pack: 1
	53.20004	μαρμ. κοντή   low stock pot 20,5 lt (32 cm   26 cm) pack: 1
	53.20005	μαρμίτα   high pot 24,5 lt (32 cm   31 cm) pack: 1
	53.20006	μαρμ. κοντή   low stock pot 29,5 lt (36 cm   29 cm) pack: 1
	53.20007	μαρμίτα   high pot 35,5 lt (36 cm   35 cm) pack: 1
	53.20008	μαρμ. κοντή   low stock pot 40 lt (40 cm   32 cm) pack: 1
	53.20009	μαρμίτα   high pot 50 lt (40 cm   40 cm) pack: 1
	53.20010	μαρμίτα   high pot 65 lt (44 cm   43 cm) pack: 1
	53.20011	μαρμίτα   high pot 77,5 lt (48 cm   43 cm) pack: 1
	53.20012	μαρμίτα   high pot 100 lt (50 cm   50 cm) pack: 1

οι διαστάσεις αναφέρονται στο εσωτερικό των σκευών

## χύτρα σωτέ | shallow pot

	53.20031	χύτρα σωτέ   shallow pot 4 lt (28 cm   7 cm) pack: 1
	53.20032	χύτρα σωτέ   shallow pot 6 lt (32 cm   7,5 cm) pack: 1
	53.20033	χύτρα σωτέ   shallow pot 8 lt (36 cm   8 cm) pack: 1
	53.20034	χύτρα σωτέ   shallow pot 10 lt (40 cm   8 cm) pack: 1
	53.20035	χύτρα σωτέ   shallow pot 22 lt (48 cm   12,5 cm) pack: 1

οι διαστάσεις αναφέρονται στο εσωτερικό των σκευών

κατσαρόλα ρηχή | *medium saucepan*



- 53.20040 κατσαρόλα ρηχή *medium saucepan*  
1,4 lt (16 cm | 7 cm)  
pack: 1
- 53.20041 κατσαρόλα ρηχή *medium saucepan*  
2 lt (18 cm | 8 cm)  
pack: 1
- 53.20042 κατσαρόλα ρηχή *medium saucepan*  
2,5 lt (20 cm | 9 cm)  
pack: 1
- 53.20043 κατσαρόλα ρηχή *medium saucepan*  
4,5 lt (24 cm | 10,5 cm)  
pack: 1
- 53.20044 κατσαρόλα ρηχή με λαβή *medium saucepan skillet*  
7 lt (28 cm | 12 cm)  
pack: 1

οι διαστάσεις αναφέρονται στο εσωτερικό των σκευών

κατσαρόλα βαθιά | *deep saucepan*



- 53.20036 κατσαρόλα βαθιά *deep saucepan*  
2,2 lt (16 cm | 11 cm)  
pack: 1
- 53.20037 κατσαρόλα βαθιά *deep saucepan*  
3 lt (18 cm | 12 cm)  
pack: 1
- 53.20038 κατσαρόλα βαθιά *deep saucepan*  
4 lt (20 cm | 13 cm)  
pack: 1
- 53.20039 κατσαρόλα βαθιά *deep saucepan*  
6,5 lt (24 cm | 15 cm)  
pack: 1

καπάκια | *lids*



- 53.20056 καπάκι | *lid*, 16 cm  
pack: 1
- 53.20057 καπάκι | *lid*, 18 cm  
pack: 1
- 53.20058 καπάκι | *lid*, 20 cm  
pack: 1
- 53.20059 καπάκι | *lid*, 24 cm  
pack: 1
- 53.20060 καπάκι | *lid*, 28 cm  
pack: 1
- 53.20061 καπάκι | *lid*, 32 cm  
pack: 1
- 53.20062 καπάκι | *lid*, 36 cm  
pack: 1
- 53.20063 καπάκι | *lid*, 40 cm  
pack: 1
- 53.20064 καπάκι | *lid*, 44 cm  
pack: 1
- 53.20065 καπάκι | *lid*, 48 cm  
pack: 1
- 53.20066 καπάκι | *lid*, 50 cm  
pack: 1

κατσαρόλα κωνική | *curved saute pan*



- 53.20052 κατσαρόλα κωνική *curved saute pan*  
0,9 lt (16 cm | 6 cm)  
pack: 1
- 53.20053 κατσαρόλα κωνική *curved saute pan*  
1,3 lt (18 cm | 6,5 cm)  
pack: 1
- 53.20054 κατσαρόλα κωνική *curved saute pan*  
1,8 lt (20 cm | 7 cm)  
pack: 1
- 53.20055 κατσαρόλα κωνική *curved saute pan*  
2,8 lt (24 cm | 7,5 cm)  
pack: 1

τηγάνι | *frying pan*



- 53.20045 τηγάνι | *frying pan*  
1,4 lt (20 cm | 5 cm)  
pack: 1
- 53.20046 τηγάνι | *frying pan*  
2,3 lt (24 cm | 5,5 cm)  
pack: 1
- 53.20047 τηγάνι | *frying pan*  
3,2 lt (28 cm | 5,5 cm)  
pack: 1
- 53.20048 τηγάνι | *frying pan*  
5 lt (32 cm | 6,5 cm)  
pack: 1
- 53.20049 τηγάνι με λαβή *frying pan with handle*  
6,1 lt (36 cm | 6,5 cm)  
pack: 1
- 53.20050 τηγάνι με λαβή *frying pan with handle*  
8,1 lt (40 cm | 7 cm)  
pack: 1
- 53.20051 τηγάνι με λαβή *frying pan with handle*  
10 lt (4 cm | 7 cm)  
pack: 1

οι διαστάσεις αναφέρονται στο εσωτερικό των σκευών



## «Culinox» copper induction

Πρωινό στη Φρανκφούρτη, δείπνο στο Νιουμπάι... τα προϊόντα της Spring είναι πάντα εκεί. Είναι τοποθετημένα σε διάσημα ξενοδοχεία σε όλο τον κόσμο, καθώς η ποιότητά τους αναγνωρίζεται. Η Spring παρέχει μια λειτουργική και οπτικά εδκνσική γκάμα. Ο μελετημένος σχεδιασμός τους τοποθετεί τις γαστρονομικές διχουδιές στο αθήνινό φως. Τέλος, το μάτι πρέπει να είναι ευχαριστημένο.

Breakfast in Frankfurt, dinner in Dubai. Always there: the products from Spring. They are represented in famous hotels around the world, as quality will succeed. Chafing Dishes keep warm delights on the buffet, wine coolers guarantee perfect drinking sensation. Spring provides a functional and visually appealing range.



	*30.20067 1554.06.20	χύτρα με καπάκι deep pot with lid 20 cm pack: 1
	*30.20064 1554.06.24	χύτρα με καπάκι deep pot with lid 24 cm pack: 1
	*30.20090 1550.06.20	χύτρα με καπάκι casserole with lid 20 cm pack: 1
	*30.20091 1550.06.24	χύτρα με καπάκι casserole with lid 24 cm pack: 1
	*30.20056 1545.06.28	χύτρα ρηχή με καπάκι shallow pot with lid 28 cm pack: 1
	*30.20063 1551.06.16	κατσαρόλι με καπάκι sauce pan with lid 16 cm pack: 1
	*30.20092 1551.06.20	κατσαρόλι με καπάκι sauce pan with lid 20 cm pack: 1
	*30.20055 1553.06.20	κατσαρόλι βαθύ με καπάκι sauce pan deep with lid 20 cm pack: 1

\*30.20089  
1485.60.20

\*30.20057  
1485.60.24

\*30.20058  
1485.60.28

\*30.20093  
1566.60.18

\*30.20066  
1566.60.20



## «Prima Matera» copper induction



### PRIMA MATERA:

η πρώτη σειρά χάλκινων σκευών ιδανικά για induction  
 • 90% χαλκός - 10% inox • χαλκός για τέλειο μαγείρεμα  
 • inox για τέλειο καθαίρισμα • μεγάλη ανθεκτικότητα από 20 σκεύη.  
 The first made copper line in the world for induction use.  
 Is 90% copper -excellent diffusion and  
 10% inox -matchless hygiene.





αντικολλητικά τηγάνια  
*«Choc intense»*  
*induction non-stick*

Κομψό βιομηχανικό σχέδιο με μαύρη βάση και γαλακτωμένη ανοξείδωτη λαβή. Σύμμα από σφυρηλατούμενο αλουμίνιο για μεγαλύτερη αντοχή. Νέας γενιάς παχιά οδόστρωτη αντικολλητική επίστρωση PTFE προσθέτει 50% έξτρα χρόνο χρήσης. Τέλειο για front cooking.

This range with a chic, industrial design combines a deep black base with gloss polished stainless steel handle and definitely does not compromise on performance. The forging process makes the aluminum border and more durable. A next generation ultra-thick reinforced non-stick coating guarantees unparalleled effectiveness and high resistance to abrasion. Perfect for delicately cooking without coloring fish, vegetables, legumes and grains.



διατίθενται  
 καπάκια  
 για όλα τα  
 τηγάνια.



αντικολλητικό τηγάνι  
*non-stick frypan*

25.00660 20 cm

8760.20 pack: 1

25.00661 24 cm

8760.24 pack: 1

25.00662 28 cm

8760.28 pack: 1

25.00663 32 cm

8760.32 pack: 1



αντικολλητικό τηγάνι κρέπας  
*non-stick crepe pan*

25.00820 26 cm

8765.26 pack: 1

25.00821 30 cm

8765.30 pack: 1



de Buyer  
DEPUIS 1730



25.00233 τηγάνι | *frying pan*

8480.20 20 cm (5 mm)

pack: 1

25.00234 τηγάνι | *frying pan*

8480.24 24 cm (5 mm)

pack: 1

25.00235 τηγάνι | *frying pan*

8480.28 28 cm (5 mm)

pack: 1

25.00236 τηγάνι | *frying pan*

8480.32 32 cm (5 mm)

pack: 1



25.00237 τηγάνι κρέπας | *crepe pan*

8485.26 26 cm (5 mm)

pack: 1



αντικολλητικά τηγάνια *«Choc Resto»* *induction non-stick*

«Choc Resto»: η συνέχεια της φημισμένης σειράς «Choc 5» τώρα σε έκδοση για όλες τις εστίες και για induction. Με συμπαγή πάνο induction, ενισχυμένες αντικολλητικές ιδιότητες, υψηλότερη αντίσταση στα γδαροσίματα, αισιόδνη λαβή και βελτιωμένες θερμικές επιδόσεις.

«Choc Resto»: the induction version of the famous «Choc 5».



## «Titanium professional» induction

τηγάνια cast aluminium  
cast aluminium frying pans

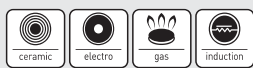

Από χυτό αλουμίνιο, κατάλληλα για όλες τις εστίες. Χρησιμοποιείται και στον φούρνο (μέχρι 250°C). Λαβή από ανοξείδωτο ατσάλι 18/10, αντικολλητική επίστρωση «Whitford Xylan» ιδιαίτερα ανθεκτική σε υψηλές θερμοκρασίες (μέχρι 250°C).

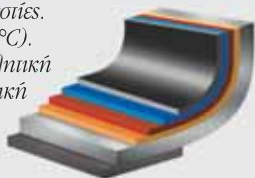

Made of cast aluminium, suitable for all heat sources and even suitable for use in ovens (up to 250°C). Handle is made from 18/10 stainless steel. The «Whitford Xylan» non-stick coating has a high temperature resistance (up to 250°C). Adhesion of the non-stick coating is improved by a layer of titanium between the aluminium and the coating.



**HENDI**

τηγάνι | frying pan

30.40288	24 cm   5 cm	pack: 1
30.40289	28 cm   5,5 cm	pack: 1
30.40290	26 cm   6 cm	pack: 1

## «Marble professional» induction

αντικολλητικά αλουμινίου  
non-stick aluminium pans



Με σιδερένια λαβή, βαφή epoxy και αντικολλητική επιφάνεια marble

**HENDI**

Iron handle epoxy coated, «marble» non-stick coating

260°C



αντικολλητικό τηγάνι induction  
non-stick induction frying pan

30.41069	20 cm   4,5 cm	pack: 1
30.40588	24 cm   4,5 cm	pack: 1
30.40589	28 cm   5 cm	pack: 1
30.40590	32 cm   5 cm	pack: 1
30.41608	36 cm   5 cm	pack: 1
30.41609	39 cm   5 cm	pack: 1

αντικολλητικά τηγάνια κρέπας  
non-stick crepe pan induction



de Buyer

τηγάνι κρέπας | crepe pan (4 mm)

25.00237	26 cm	8485.26	pack: 1
*25.00389	30 cm	8485.30	pack: 1



**HENDI**

τηγάνι κρέπας | crepe pan (4 mm)

30.41799	24 cm   2,5 cm	pack: 1
30.41800	28 cm   2 cm	pack: 1



## «Choc Resto» induction



de Buyer

HACCP

αντικολλητικό τηγάνι με κίτρινο χέρι  
non-stick frying pan with yellow handle

25.00458	20 cm   3 cm	8470.20	pack: 1
25.00459	24 cm   3,5 cm	8470.24	pack: 1
25.00439	28 cm   3,8 cm	8470.28	pack: 1
25.00460	32 cm   4,7 cm	8470.32	pack: 1



αντικολλητικό τηγάνι με κόκκινο χέρι  
non-stick frying pan with red handle

25.00461	20 cm   3 cm	8450.20	pack: 1
25.00462	24 cm   3,5 cm	8450.24	pack: 1
25.00440	28 cm   3,8 cm	8450.28	pack: 1
25.00463	32 cm   4,7 cm	8450.32	pack: 1



τηγάνι αντικολλητικό με πράσινο χέρι  
non-stick frying pan with green handle

25.00464	20 cm   3 cm	8460.20	pack: 1
25.00465	24 cm   3,5 cm	8460.24	pack: 1
25.00441	28 cm   3,8 cm	8460.28	pack: 1
25.00466	32 cm   4,7 cm	8460.32	pack: 1



τηγάνι αντικολλητικό με μπλε χέρι  
non-stick frying pan with blue handle

25.00467	20 cm   3 cm	8440.20	pack: 1
25.00468	24 cm   3,5 cm	8440.24	pack: 1
25.00442	28 cm   3,8 cm	8440.28	pack: 1
25.00469	32 cm   4,7 cm	8440.32	pack: 1



επιφάνεια γκριλ induction griddle cooking



30.41453  
επιφάνεια γκριλ  
griddle induction cooking  
39x26 cm  
pack: 1





de Buyer

## «Choc 5» αντικολλητικά non-stick

Κατασκευή από παχύ αλουμίνιο με 5 στρώσεις «PTFE» και εγνημένα χωρίς PFOA.

Thick aluminium with 5 layers of PTFE without PFOA

	αντικολλητικό τηγάνι non-stick frying pan
25.00010	20 cm   3 cm 8180.20 pack: 1
25.00012	24 cm   3,5 cm 8180.24 pack: 1
25.00013	26 cm   3,7 cm 8180.26 pack: 1
25.00014	28 cm   4 cm 8180.28 pack: 1
25.00015	30 cm   4,2 cm 8180.30 pack: 1
25.00016	32 cm   4,5 cm 8180.32 pack: 1
25.00017	36 cm   4,8 cm 8180.36 pack: 1
25.00018	40 cm   5,4 cm 8180.40 pack: 1
	τηγάνι κωνικό σωτέ αντικολλητικό non-stick conical saute pan
25.00038	24 cm   7 cm 8188.24 pack: 1
25.00039	28 cm   7 cm 8188.28 pack: 1
	τηγάνι κρέπας αντικολλητικό non-stick crepe pan
25.00019	22 cm   1,5 cm 8185.22 pack: 1
25.00020	26 cm   1,5 cm 8185.26 pack: 1
25.00021	30 cm   1,5 cm 8185.30 pack: 1
	*25.00366 τηγάνι ορθογώνιο αντικολλητικό non-stick rectangular frying pan
8184.38	38x26 cm   4,2 cm pack: 1



## HENDI «Titanium professional»

τηγάνια cast aluminium  
cast aluminium frying pans



Από χυτό αλουμίνιο, καιάλληλα για όλες τις εστίες. Χρησιμοποιείται και στον φούρνο (μέχρι 250°C). Λαβή από ανοξείδωτο ατσάδι 18/10, αντικολλητική επίστρωση «Whitford Xylan» ιδιαίτερα ανθεκτική σε υψηλές θερμοκρασίες (μέχρι 250°C).



Made of cast aluminium, suitable for all heat sources and even suitable for use in ovens (up to 250°C). Handle is made from 18/10 stainless steel. The «Whitford Xylan» non-stick coating has a high temperature resistance (up to 250°C). Adhesion of the non-stick coating is improved by a layer of titanium between the aluminium and the coating.



	τηγάνι   frying pan
30.40578	24 cm   5,5 cm pack: 1
30.40579	28 cm   5,5 cm pack: 1
30.40580	32 cm   5,5 cm pack: 1
30.40581	36 cm   5,5 cm pack: 1
30.40582	40 cm   5,5 cm pack: 1
	30.40585 τηγάνι σωτέ saute pan
	28 cm   8,5 cm pack: 1
	30.40587 τηγάνι wok wok pan
	32 cm   10 cm pack: 1
	*30.40583 τηγάνι grill grill pan
	28x28 cm   5,5 cm pack: 1
	30.40586 τηγάνι ψαριού fish frying pan
	40x27,5 cm   3,5 cm pack: 1
	30.40584 τηγάνι κρέπας crepe pan
	32 cm   2 cm pack: 1



για ξύλινες  
κουτάλες  
ανατρέξτε...



σελίδα **402**  
KOYZINA

## «Choc 5»



 <p><b>HACCP</b></p>	αντικολλητικό τηγάνι με κίτρινο χέρι <i>non-stick frying pan with yellow handle</i>	25.00358 28 cm   4 cm 8070.28 pack: 1
	25.00359 32 cm   4,5 cm 8070.32 pack: 1	
	αντικολλητικό τηγάνι με κόκκινο χέρι <i>non-stick frying pan with red handle</i>	25.00360 28 cm   4 cm 8050.28 pack: 1
	25.00361 32 cm   4,5 cm 8050.32 pack: 1	
	τηγάνι αντικολλητικό με πράσινο χέρι <i>non-stick frying pan with green handle</i>	25.00362 28 cm   4 cm 8060.28 pack: 1
	25.00363 32 cm   4,5 cm 8060.32 pack: 1	
	τηγάνι αντικολλητικό με μπλε χέρι <i>non-stick frying pan with blue handle</i>	25.00364 28 cm   4 cm 8040.28 pack: 1
	25.00365 32 cm   4,5 cm 8040.32 pack: 1	

## wok

 <p><b>HENDI</b></p>	30.40107 τηγάνι wok, inox με επίπεδη βάση <i>flat-bottomed wok, inox 3-ply (2 inox - 1 aluminium)</i>	36 cm   9 cm pack: 1
	30.41335 28 cm (base 21 cm)   7,5 cm pack: 1	
 <p><b>HENDI</b></p>	τηγάνι wok αλουμινίου αντικολλητικό <i>non-stick aluminium wok</i>	30.41336 32 cm (base 21 cm)   10 cm pack: 1
	35.01379 τηγάνι wok ατσάλινο αντικολλητικό <i>carbon steel non-stick wok</i>	35,5 cm pack: 1/6
 <p><b>KitchenCraft</b></p>		

## induction Carbone steel



 <p><b>de Buyer</b></p>	25.00300 20 cm   3,2 cm 5110.20 pack: 1/3
	25.00301 22 cm   4 cm 5110.22 pack: 1/3
	25.00470 24 cm   3,5 cm 5110.24 pack: 1/3
	25.00302 26 cm   4 cm 5110.26 pack: 1/3
	25.00303 28 cm   4 cm 5110.28 pack: 1/3
	25.00357 32 cm   5 cm 5110.32 pack: 1/3

## τηγάνια «Blue Steel» frying pans



Γερή σιδερένια κατασκευή, 1-1,5 mm πάχος, γρήγορο ζέσταμα.

Sturdy construction, made of 1-1.5 mm thick iron, fast heating.



 <p><b>de Buyer</b></p>	25.00002 24 cm   4,8 cm 5020.24 pack: 1
	25.00003 26 cm   5 cm 5020.26 pack: 1
	25.00004 28 cm   5,1 cm 5020.28 pack: 1
	25.00005 32 cm   5,8 cm 5020.32 pack: 1
	25.00006 36 cm   6,2 cm 5020.36 pack: 1
	25.00007 40 cm   7 cm 5020.40 pack: 1

## φριτούρες | deep fryers

 <p><b>de Buyer</b></p>	φριτούρες   <i>deep fryers</i>
	25.00221 32 cm   9,3 cm 5050.32 pack: 1
	25.00284 40 cm   13,1 cm 5050.40 pack: 1
	25.00396 45 cm   14,5 cm 5050.45 pack: 1
	καλάθια φριτούρας   <i>tinned wire basket</i>
	25.00335 32 cm   8,7 cm για 5051.32 pack: 1
	25.00319 39 cm   12,4 cm για 5051.40 pack: 1
	25.00398 45 cm   15 cm για 5051.45 pack: 1

## τηγάνια παέγια σιδερένια | st. steel paella pans



 <p><b>HENDI</b></p>	τηγάνι παέγια   <i>paella pan</i>
	*30.40591 34 cm   4 cm pack: 1
	*30.40592 46 cm   4 cm pack: 1
	*30.40593 60 cm   4 cm pack: 1
	*30.40594 80 cm   5 cm pack: 1



δέσσοι αλουμίνου | *aluminium trays*

		δέσσοι αλουμίνου (βαριόι 1,5 mm) <i>aluminium baking tray - Special bard                  1,5mm-thick aluminium</i>
		*25.00808 40x30 cm 7360.40 pack: 1
		*25.00809 GN 1/1 (53x32,5 cm) 7360.53 pack: 1



δέσσοι ψησίματος GN | *oven trays*

	30.40113 δέσσο αλουμίνου GN 1/1 διάτρητος με 4 πλευρές <i>aluminium perforated                  tray GN 1/1 with 4 rims</i> 53x32,5 cm pack: 1
	30.41910 δέσσο αλουμίνου GN 1/1 διάτρητος με 4 πλευρές αντικολλητικός <i>aluminium perforated                  tray with 4 rims, non-stick</i> 53x32,5 cm pack: 1
	30.41911 δέσσο αλουμίνου GN 1/1 με 4 πλευρές αντικολλητ. <i>aluminium tray                  with 4 rims, non-stick</i> 53x32,5 cm pack: 1
	30.40506 δέσσο αλουμίνου GN 2/3 διάτρητος με 4 πλευρές <i>aluminium perforated                  tray GN 1/1 with 4 rims</i> 35,4x32,5 cm pack: 1
	30.40507 δέσσο αλουμίνου GN 2/3 διάτρητος με 4 πλευρές αντικολλητικός <i>aluminium perforated                  tray with 4 rims, non-stick</i> 35,4x32,5 cm pack: 1



αντικολλητικοί δέσσοι «Choc 5» *non-stick trays*

		αντικολλητικοί δέσσοι   <i>non-stick trays</i>
		25.00026 GN 1/1 8161.53 pack: 1  25.00027 60x40 cm 8161.60 pack: 1

δέσσοι αλουμίνου  
 διάτρητοι δέσσοι αλουμίνου  
*perforated aluminium trays*

		δέσσο αλουμίνου (βαριόι 1,5 mm) <i>aluminium baking tray - Special bard                  1,5mm-thick aluminium</i>
		*25.00811 40x30 cm 7367.40 pack: 1
		*25.00812 GN 1/1 (53x32,5 cm) 7367.53 pack: 1

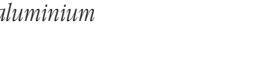
		δέσσοι αλουμίνου (βαριόι 1,5 mm) <i>aluminium baking tray - Special bard                  1,5mm-thick aluminium</i>
		*25.00814 40x30 cm 7368.40 pack: 1
		*25.00815 GN 1/1 (53x32,5 cm) 7368.53 pack: 1

δέσσοι ψησίματος (3 πλευρές) | *oven trays (3 rims)*

	30.41904 δέσσο αλουμίνου με 3 πλευρές <i>aluminium tray with 3 rims</i> 60x40 cm pack: 1
	30.40883 δέσσο αλουμίνου διάτρητος με 3 πλευρές <i>aluminium perforated                  tray with 3 rims</i> 60x40 cm pack: 1
	30.41905 δέσσο αλουμίνου διάτρητος με 3 πλευρές αντικολλητικός <i>aluminium perforated                  tray with 3 rims, non-stick</i> 60x40 cm pack: 1





δίσκοι μπαγκετών | french bread trays



**30.41345** δίσκος αλουμινίου διάτρητος για 5 μπαγκέτες *aluminium perforated tray for 5 french bread*, 60x40 cm  
pack: 1



**30.41906** δίσκος αλουμινίου διάτρητος για 5 μπαγκέτες αντικολλητικός *aluminium perforated tray for 5 french bread, non-stick* 60x40 cm  
pack: 1

ταψιά | roasting pans



ταψί φούρνου inox με λαβές *roast pan falling handles, inox*

**30.40136** 30x22 cm | 13 cm  
pack: 1



**30.40137** 35x25 cm | 16 cm  
pack: 1

**30.40138** 40x28 cm | 22 cm  
pack: 1



σχάρες στεγνώματος | pastry grids



**10.50023** σχάρα στεγνώματος inox *dryer set* 23x35 cm | 5,4 cm  
pack: 1



**25.40049** σχάρα ορθογώνια *cake cooler* NC1054060 30,5x22 cm  
pack: 1



**34.20028** σχάρα ορθογώνια με πόδια *cake cooling rack* 30,5x23 cm | 1,2 cm  
pack: 1



**34.20080** σχάρα ορθογώνια αντικολλητική με πόδια *cake cooling non-stick rack* 35x25 cm  
pack: 1

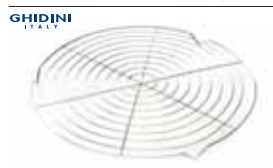

**10.50027** σχάρα στρογγυλή inox *round cake cooler* 32 cm  
pack: 1



**\*25.40048** σχάρα στρογγυλή *round cake cooler* 36 cm  
pack: 1

γκρίλιες | baking wire grates



**25.00048** γκρίλια inox | *wire grate* GN 1/1 - 53x32,5 cm 3330.53  
pack: 1



**25.00049** γκρίλια inox | *wire grate* 60x40 cm 3330.60  
pack: 1



**\*25.00620** γκρίλια inox | *wire grate* GN 2/1 - 65x53 cm 3330.65  
pack: 1

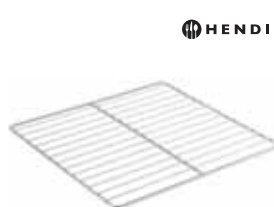

**30.41349** γκρίλια inox GN 2/3 *wire grate 18/10 GN 2/3* 35,4x32,5 cm  
pack: 1

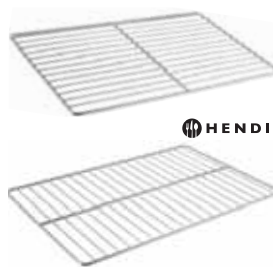

**30.40905** σχάρα inox GN 1/1 *grid inox GN 1/1* 53x32,5 cm  
pack: 1



**30.41344** σχάρα inox GN 1/1 με οριζόντιο πλέγμα *grid transverse, inox GN 1/1* 53x32,5 cm  
pack: 1

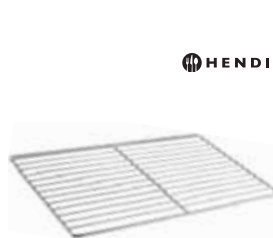

**30.41907** σχάρα inox με οριζόντιο πλέγμα *grid transverse, inox* 60x40 cm  
pack: 1

**30.41908** σχάρα inox επιχρωμιωμένη *grid chrome plated* 60x40 cm  
pack: 1

**30.41909** σχάρα inox *grid*, 60x40 cm  
pack: 1

χάλκινες μπασίβες ασπραδιών | *copper eggwhites bowls*

	de Buyer 
	*25.00481 6580.26 μπασίβα ασπραδιών με ένα χέρι   <i>eggwhites bowl with 1 handle</i> , 16,7 lt 26 cm (1,2 mm) pack: 1



μπολ ανάμιξης inox | *mixing bowls*

	HENDI
	μπολ ανάμιξης με επίπεδη βάση <i>flat bottom mixing bowls</i>
	30.40001 0,8 lt (16 cm   6,5 cm) pack: 1
	30.41610 1,3 lt (20,5 cm   7 cm) pack: 1
	30.40002 1,6 lt (22,5 cm   8 cm) pack: 1
	30.41611 2,3 lt (25 cm   8,4 cm) pack: 1
30.40003 3,1 lt (27,8 cm   10 cm) pack: 1	
30.40004 5 lt (35,5 cm   11 cm) pack: 1	
30.40005 6 lt (35 cm   12 cm) pack: 1	

	HENDI
	μπολ ανάμιξης ημισφαιρικό <i>hemispherical bowl</i>
	30.40006 0,7 lt (15,8 cm   5,5 cm) pack: 1
	30.40007 1,4 lt (19,7 cm   6,8 cm) pack: 1
	30.40008 2,3 lt (24 cm   8,8 cm) pack: 1
30.40009 3,3 lt (25,9 cm   9,2 cm) pack: 1	
30.40010 4,9 lt (30 cm   11,8 cm) pack: 1	

μπολ ανάμιξης inox | *mixing bowls*

	de Buyer 
	μπολ ανάμιξης ημισφαιρικό, inox <i>hemispherical bowl</i>
	*25.00569 2,1 lt (20 cm) 3372.20 pack: 1
	*25.00208 7 lt (30 cm) 3372.30 pack: 1
	*25.00424 11,2 lt (35 cm) 3371.35 pack: 1
*25.00421 16,8 lt (40 cm) 3371.40 pack: 1	
*25.00209 3379.01 βάση για ημισφαιρικά μπολ 30-40 cm <i>round stand for bowls</i> pack: 1	

	de Buyer 
	μπολ ανάμιξης inox με επίπεδη βάση <i>flat bottom mixing bowls</i>
	*25.00477 1 lt (16 cm   9 cm) 0,8mm 3250.16 pack: 1
	*25.00429 2 lt (20 cm   10 cm) 0,8mm 3250.20 pack: 1
	*25.00478 3,5 lt (24 cm   11,5 cm) 1mm 3250.24 pack: 1
	*25.00243 5,5 lt (28 cm   12,5 cm) 1mm 3250.28 pack: 1
*25.00182 8 lt (32 cm   14 cm) 1mm 3250.32 pack: 1	
25.00416 16 lt (40 cm   17,5 cm) 1,2mm 3250.40 pack: 1	

μπολ ανάμιξης PP | *mixing bowls polypropylene*

	araven
	46.01070 μπολ   <i>bowl</i> , 0,5 lt 13 cm   6 cm pack: 24
	46.01071 μπολ   <i>bowl</i> , 1 lt 17 cm   8 cm pack: 24
	46.01072 μπολ   <i>bowl</i> , 2,5 lt 23,5 cm   11 cm pack: 12
	46.01073 μπολ   <i>bowl</i> , 4,5 lt 28 cm   14 cm pack: 12
46.01074 μπολ   <i>bowl</i> , 7 lt 32,5 cm   16 cm pack: 6	
46.01075 μπολ   <i>bowl</i> , 11 lt 38 cm   18 cm pack: 6	



μπολ ανάμιξης PP *mixing bowls*

	de Buyer 
	μπολ ανάμιξης ημισφαιρικό, PP <i>hemispherical bowl PP</i>
	25.00797 2,5 lt (23 cm   10,5 cm) 4530.23 pack: 1
25.00798 6 lt (32 cm   14,5 cm) 4530.32 pack: 1	
25.00799 13 lt (40 cm   18 cm) 4530.40 pack: 1	

σουρωτήρια ενισχυμένα | *reinforced sieves*

	<p><b>HENDI</b></p> <p>σουρωτήρια ενισχυμένα με διπλή σίτα και ξύλινο χέρι <i>sieve, double mesh with wooden handle, reinforced bracket</i></p> <p>30.40140 57 cm   26 cm pack: 1</p> <p>30.40141 80 cm   31 cm pack: 1</p> <p>30.40604 86 cm   36 cm pack: 1</p>
	<p>60.61062 σουρωτήρι ενισχυμένο με inox λαβή <i>reinforced sieve with inox handle</i> 25 cm pack: 1</p>

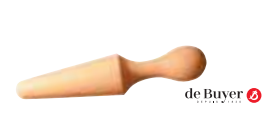

σινουά | *conical strainers*

	<p><b>de Buyer</b></p> <p>*25.00369 σινουά μαγειρικής <i>kitchen chinese strainer</i> (διάτρηση/micro-perforated 1,5 mm) 20 cm   18 cm pack: 1</p>
	<p>30.40026 σινουά   <i>chinese strainer</i> 18,5 cm   35 cm pack: 1</p> <p>30.40027 σινουά   <i>chinese strainer</i> 23,5 cm   39,5 cm pack: 1</p>
	<p>60.61053 σινουά   <i>chinese strainer</i> 20 cm pack: 1</p> <p>60.61054 σινουά   <i>chinese strainer</i> 25 cm pack: 1</p>
	<p>*25.00377 πιεστήρας ξύλινος   <i>pusher</i> 5 cm   25,5 cm pack: 1</p>

σουρωτήρι κωνικό mesh | *conical mesh stainer*

	<p><b>HENDI</b></p> <p>30.40220 σουρωτήρι κωνικό mesh <i>conical mesh stainer</i> 18x39,5 cm pack: 1</p>
--	--

σουρωτήρια χειρός ανοξείδωτα | *inox mesh strainers*

	<p><b>PKS</b></p> <p>60.61022 8 cm pack: 1</p> <p>60.61023 10 cm pack: 1</p> <p>60.61024 12 cm pack: 1</p>
	<p>60.61025 14 cm pack: 1</p> <p>60.61026 16 cm pack: 1</p> <p>60.61027 18 cm pack: 1</p> <p>60.61028 20 cm pack: 1</p> <p>60.61029 25 cm pack: 1</p>

σουρωτήρια χειρός ανοξείδωτα | *inox mesh strainers*

	<p><b>PKS</b></p> <p>60.61041 7 cm pack: 1</p> <p>60.61042 8 cm pack: 1</p> <p>60.61043 10 cm pack: 1</p>
	<p>60.61044 12 cm pack: 1</p> <p>60.61045 14 cm pack: 1</p> <p>60.61046 16 cm pack: 1</p> <p>60.61047 18 cm pack: 1</p> <p>60.61048 20 cm pack: 1</p> <p>60.61049 22 cm pack: 1</p> <p>60.61050 25 cm pack: 1</p>

δοχείο στραγγίσματος | *chips colander aluminium*

	<p><b>HENDI</b></p> <p>30.40595 δοχείο στραγγίσματος τηγανπτόν με αποσπώμενο σουρωτήρι <i>chips colander - fixed bottom and removable strainer</i> 40 cm   17 cm pack: 1</p>
--	--



### σουρωτήρια inox | colanders inox

	<p><b>HENDI</b> σουρωτήρι κωνικό inox, βαρύ <i>st. steel conical colander</i></p> <p>30.40299 32 cm   18 cm pack: 1</p> <p>30.40300 36 cm   20 cm pack: 1</p> <p>30.40301 40 cm   22 cm pack: 1</p>
	<p>σουρωτήρι inox   <i>st. steel colander</i></p> <p>73.20009 24,5 cm pack: 1</p> <p>73.20010 29,5 cm pack: 1</p> <p>30.40030 34 cm pack: 1</p>
	<p><b>HENDI</b> σουρωτήρι διάτρητο <i>colander perforated</i> 31,5 cm   12 cm pack: 1</p>
	<p>σουρωτήρια polypropylene <i>colander polypropylene</i></p> <p>46.01082 23x15 cm pack: 12</p> <p>46.01083 28x12,3 cm pack: 12</p> <p>46.00483 38x17,2 cm pack: 5</p>



### εργαλεία ζαχαροπλαστικής | pastry tools

	<p><b>de Buyer</b></p> <p>25.00109 4782.00 δοχείο με σίτα <i>dredger with metal mesh</i> inox, 7 cm   13 cm (35 cl) pack: 1</p> <p>25.00110 4783.00 δοχείο με τρύπες 1,5 mm. <i>dredger - small holes</i> inox, 7 cm   13 cm (35 cl) pack: 1</p> <p>25.00111 4783.01 δοχείο με μεγάλες τρύπες <i>dredger - large holes</i> inox, 7 cm   13 cm (35 cl) pack: 1</p>
	<p><b>GHIDINI ITALY</b> 10.50026 αχνορίχτης ανοξείδωτος με καπάκι για κακάο και άχνη ζάχαρη <i>dredger with metal mesh</i> 7 cm   9 cm pack: 1</p>



### κόσκινα | baker's sieve

	<p><b>de Buyer</b></p> <p>25.00800 4605.21 κόσκινο inox με 4 σίτες <i>st. steel sieve with 4 removable meshes</i> (σίτες / meshes: 3-2-1-0,5 mm) 20 cm pack: 1</p>
	<p>κόσκινο άχνης <i>sieve for powdered sugar</i></p> <p>30.40605 25 cm   7,5 cm pack: 1</p> <p>30.40608 40 cm   7,5 cm pack: 1</p>
	<p>κόσκινο αλευριού <i>sieve for flour and meal</i></p> <p>30.40606 25 cm   7,5 cm pack: 1</p> <p>30.40609 40 cm   7,5 cm pack: 1</p>
	<p>κόσκινο χοντρό <i>sieve for bread-crumbs</i></p> <p>30.40607 25 cm   7,5 cm pack: 1</p> <p>30.40610 40 cm   7,5 cm pack: 1</p>
	<p>10.40506 3532 κόσκινο mesh λεπτό (άχνη, κακάο) <i>sieve for powdered sugar</i> 15 cm pack: 1</p> <p>10.40507 3533 κόσκινο mesh χονδρό (αλεύρι) <i>sieve for flour and meal</i> 15 cm pack: 1</p>

### χωνιά | funnel

	<p>30.40031 χωνί, inox <i>st. steel funnel</i> 12 cm pack: 1</p>
	<p>34.00165 mini χωνί inox <i>mini funnel, st. steel</i> 5,5 cm pack: 6</p>
	<p><b>HENDI</b></p> <p>30.41173 χωνιά   <i>funnel</i> PP, 10 cm pack: 1</p> <p>30.41174 χωνιά   <i>funnel</i> PP, 12,7 cm pack: 1</p> <p>30.41175 χωνιά   <i>funnel</i> PP, 15 cm pack: 1</p>

σέσουλες | scoops

	<p><b>HENDI</b> σέσουλες αλουμινίου   <i>aluminium scoops</i></p>
	<p>30.40614 18 cm (12,5 cl) pack: 1</p>
	<p>30.40615 21 cm (20 cl) pack: 1</p>
	<p>30.40616 25 cm (30 cl) pack: 1</p>
	<p>30.40617 26,5 cm (50 cl) pack: 1</p>
	<p>σέσουλες PP   <i>PP scoops</i></p>
	<p>30.40611 18,7 cm (12,5 cl) pack: 1</p>
	<p>30.40612 25 cm (25 cl) pack: 1</p>
<p>30.40613 33 cm (65 cl) pack: 1</p>	

σέσουλες  
«CamWaver®»  
scoops

Αθάναιες και βοδικές  
σέσουλες PC  
*Virtually unbreakable  
scoops will not dent,  
chip or rust.*





**CAMBRO**

	<p>92.00850 σέσουλα 170 gr SCP6CW <i>scoop 170 gr</i> pack: 12</p>
	<p>92.00851 σέσουλα 340 gr SCP12CW <i>scoop 340 gr</i> pack: 12</p>
	<p>92.00852 σέσουλα 680 gr SCP24CW <i>scoop 680 gr</i> pack: 12</p>
	<p>92.00853 σέσουλα 1,814 gr SCP64CW <i>scoop 1.814 gr</i> pack: 6</p>

σέσουλες | scoops

	<p><b>GHIDINI</b> ITALY</p> <p>10.40550 σέσουλες μικρές, σετ 3 τμχ. <i>set of 3 small scoops</i> pack: 3/36</p>
---	---

μεζούρες | measuring cups

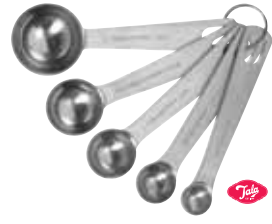
	<p><b>de Buyer</b></p> <p>25.00139 σετ 4 μεζούρες κούπες: 4827.02 1/4 - 1/3 - 1/2 - 1 κούπα <i>set of 4 measuring cups: 1/4 - 1/3 - 1/2 - 1 cup</i> pack: 1</p>
	<p><b>KitchenCraft</b></p> <p>35.02887 σετ 4 μεζούρες κουτάλια copper <i>set of 4 copper effect measuring spoon</i> 1 tbsp - 1 tsp - 1/2 tsp - 1/4 tsp pack: 1</p>
	<p>34.00139 σετ 5 μεζούρες κουτάλια <i>set of 4 measuring spoons</i> pack: 6</p>

	<p>34.20061 σετ 4 διπλές μεζούρες <i>set of 4 double measurements</i> a: 1/4 cup - 60 ml / 1/4 tsp - 1,25 ml b: 1/3 cup - 80 ml / 1/2 tsp - 2,5 ml c: 1/2 cup - 120 ml / 1 tsp - 5 ml d: 1 cup - 235 ml / 1 tbs - 15 ml pack: 1</p>
---	---

	<p>μεζούρες γυάλινες πυρίμαχες <i>fireproof measurements</i></p> <p>90.55175 0,25 lt - 8 oz - 1 cup pack: 4</p> <p>90.55177 0,5 lt - 16 oz - 2 cups pack: 4</p> <p>90.55178 1 lt - 32 oz - 4 cups pack: 3</p>
--	---

	<p>90.91016 μεζούρα γυάλινη πυρίμαχη <i>measuring glass</i> 5 oz pack: 1</p>
--	--



κανάτες/μεζούρες «CamWare®» *measuring cups*

Δύσθρανοιες κανάτες PC με  
ενανάγνωστες μειρήσεις.  
*Externally marked gradua-  
tions are molded in  
and imprinted in red for  
American standard  
and blue for metric for  
easy measurement.*



**CAMBRO**

	<b>92.00861</b> μεζούρα 225 ml 25MCCW pack: 12
	<b>92.00863</b> μεζούρα 0,5 lt 50MCCW pack: 12
	<b>92.00859</b> μεζούρα 1 lt 100MCCW pack: 12
	<b>92.00860</b> μεζούρα 2 lt 200MCCW pack: 12
	<b>92.00862</b> μεζούρα 4 lt 400MCCW pack: 1

κουβάς αποθήκευσης | *pail with bail*

**CAMBRO**



<b>92.00519</b> PWB22148	κουβάς PE για προετοιμασία, αποθήκευση, μεταφορά και τροφίμων <i>multi-purpose pail, ideal for mixing, storing and transporting</i> pack: 6
<b>92.00521</b> RFSC12	καπάκι κουβά <i>cover for pail</i> pack: 6

κανάτες μεζούρες | *measuring jugs*

	<b>HENDI</b> κανάτες μεζούρες PP <i>PP measuring jugs</i> <b>30.40013</b> 0,5 lt (9 cm   14 cm) pack: 1
	<b>30.40139</b> 1 lt (11 cm   17 cm) pack: 1
	<b>30.40014</b> 2 lt (14 cm   21,5 cm) pack: 1
	<b>30.40015</b> 3 lt (16 cm   24 cm) pack: 1
	<b>30.40016</b> 5 lt (19 cm   27 cm) pack: 1
	κανάτες μεζούρες PP στοιβαζόμενες <i>PP stackable measuring jugs</i> <b>30.41823</b> 0,5 lt (9,5 cm   13,6 cm) pack: 1
	<b>30.41454</b> 1 lt (12,5 cm   17,2 cm) pack: 1
	<b>30.41455</b> 2 lt (14,7 cm   21,5 cm) pack: 1
	<b>30.41456</b> 3 lt (17,2 cm   24,1 cm) pack: 1
	<b>30.41457</b> 5 lt (21,5 cm   27,1 cm) pack: 1
	<b>HENDI</b> κανάτες μεζούρες inox <i>inox measuring jugs</i> <b>30.42041</b> 0,5 lt (9 cm   11 cm) pack: 1
	<b>30.40017</b> 1 lt (12 cm   13,5 cm) pack: 1
	<b>HENDI</b> μεζούρες inox με ενισχυμένη βάση <i>inox measuring jugs with reinforced base</i> <b>30.41176</b> 7 lt (23 cm   24,5 cm) pack: 1
	<b>30.40012</b> 12 lt (29 cm   30,5 cm) pack: 1
	<b>HENDI</b> <b>30.41177</b> κουβάς inox   <i>inox bucket</i> 12 lt (31 cm   30 cm) pack: 1

## κουτάλες ανοξείδωτες | *utensils*

Επαγγελματικά εργαλεία κουζίνας, πάχους 2,5 mm.  
Ανθεκτικά, εργονομικά. Με ένδειξη διαμέτρου και λίτρου

Heavy duty st. steel utensils. Handle thickness: 2,5 mm. Professional and robust. Ergonomic shape and multi-support book.  
Diameter and/or liter engraved on the handle



**de Buyer**

κουτάλες βαθιές, ανοξείδωτες  
*st. steel ladles*

**25.00053** 6 cm | 33,5 cm (5 cl)  
3130.06 pack: 1

**25.00054** 8 cm | 39 cm (13 cl)  
3130.08 pack: 1

**25.00055** 10 cm | 44,5 cm (25 cl)  
3130.10 pack: 1

**25.00056** 12 cm | 50 cm (45 cl)  
3130.12 pack: 1



**de Buyer**

κουτάλες τρυπητές, ανοξείδωτες  
*st. steel skimmers*

**25.00061** 8 cm | 40 cm  
3150.08 pack: 1

**25.00062** 10 cm | 45 cm  
3150.10 pack: 1

**25.00063** 12 cm | 50 cm  
3150.12 pack: 1

**25.00065** 16 cm | 58,5 cm  
3150.16 pack: 1



**de Buyer**

σπάτουλες, ανοξείδωτες  
*st. steel spatulas*

**25.00066** απλή | *plain*  
3142.10 10 cm | 36,5 cm  
pack: 1

**25.00067** τρυπητή | *perforated*  
3141.10 10 cm | 36,5 cm  
pack: 1

## κουτάλες βαριάς χρήσης (2,7 mm) | *heavy duty utensils*



κουτάλες βαθιές, st. steel  
*st. steel non-drip ladles*

**30.40622** 6 cm | 30 cm (5 cl)  
pack: 1

**30.40623** 8 cm | 32 cm (12,5 cl)  
pack: 1

**30.40624** 10 cm | 40 cm (25 cl)  
pack: 1

**30.40625** 12 cm | 45 cm (50 cl)  
pack: 1

**30.40626** 14,5 cm | 44 cm (75 cl)  
pack: 1

**30.40627** 16,5 cm | 48 cm (1 lt)  
pack: 1



κουτάλες τρυπητές, st. steel  
*st. steel skimmers*

**30.40628** 8 cm | 39 cm  
pack: 1

**30.40629** 10 cm | 40 cm  
pack: 1

**30.40630** 12 cm | 46 cm  
pack: 1

**30.40631** 16 cm | 53 cm  
pack: 1



**30.40634** κουτάλα λοξή, st. steel  
*st. steel side basting spoon*  
10x6,5 cm | 43 cm  
pack: 1

**30.40633** κουτάλα, st. steel  
*st. steel straight basting spoon*  
10x6,5 cm | 48 cm  
pack: 1

**30.40632** σπάτουλα, st. steel  
*st. steel spatula*  
10x11 cm | 51 cm  
pack: 1

**30.40021** πιρούνα, st. steel  
*st. steel vegetable spoon*  
35 cm  
pack: 1

## εργαλεία κουζίνας | *kitchen utensils*



κουτάλα σάλτσας λοξή  
*one piece sauce ladle*

**19.55015** 27 cm  
50926300 pack: 1

**ΡΙΝΤΙΝΟΧ**

## κουτάλα φωλιά | *bird's nest shaped strainer*



**HENDI**

**30.40663** κουτάλα φωλιά  
*bird's nest shaped strainer*  
8/10 cm | 39,5 cm  
pack: 1



κουτάλες μονοκόμματες (1,5 mm) | *utensils one piece*

κουτάλες βαθιές, st. steel | *st. steel non-drip ladles*

30.40144	6,5 cm   30 cm	pack: 1
30.40145	9 cm   36 cm	pack: 1
30.40146	10 cm   38 cm	pack: 1

κουτάλες τρυπητές, st. steel | *st. steel skimmer*

30.40147	10 cm   34 cm	pack: 1
30.40148	13 cm   38,5 cm	pack: 1

30.40149 οπάτουλα, st. steel | *st. steel spatula*,  
34 cm

pack: 1

30.40151 οπάτουλα τρυπητή, st. steel | *slotted spatula*,  
34 cm

pack: 1

30.40150 κουτάλα σερβιρ. st. steel | *st. steel basting spoon*  
34,5 cm

pack: 1

σέσουλα τηγανητών | *french fries funnel scoop*

30.40664  
σέσουλα τηγανητών με 2 χέρια (άνοιγμα: 7,5 cm)  
*french fries funnel scoop*  
*with detachable handles*  
*fill opening: 7,5 cm*  
20x23 cm  
pack: 1



HENDI

σέσουλα τηγανητών | *french fries funnel scoop*

	<p>30.40900 σέσουλα τηγανητών PC με 2 χέρια (άνοιγμα: 7,5 cm) <i>french fries funnel scoop PC</i> <i>with detachable handles</i> <i>fill opening: 7,5 cm</i> 20,5x23,3 cm pack: 1</p>
	<p>HENDI</p>

αράχνες | *chip scoops*

κουτάλες αράχνη st. steel ενισχυμένες  
*reinforced chip scoops*

30.40636	16 cm   45 cm	pack: 1
30.40023	18 cm   47 cm	pack: 1
30.40024	20 cm   51 cm	pack: 1
30.42044	20 cm   54 cm	pack: 1
30.40025	24 cm   55 cm	pack: 1



30.40637 κουτάλα αράχνη βαθιά  
st. steel, με χέρι PA  
*st. steel chip scoop with PA*  
*handle and extra deep scoop*  
26 cm | 60 cm  
pack: 1



30.40899 κουτάλα αράχνη  
st. steel, με συρμάτινη  
λαβή  
*st. steel chip scoop*  
*with wire handle*  
12,5 cm | 42 cm  
pack: 1

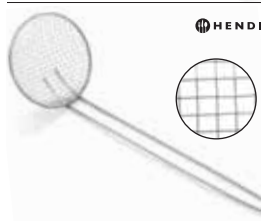

κουτάλα «αράχνη» | *wire skimmer*  
34.20078 42 cm  
pack: 1/10



κουτάλα λίπους  
*fat skimmer - fine mesh*

30.41342	12,5 cm   35 cm	pack: 1
30.40222	15 cm   43 cm	pack: 1

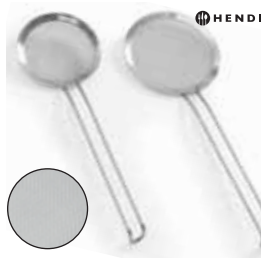





κουτάλες ξύλινες | wooden spoons

	30.40223 ξύλινες κουτάλες (σετ 3) wooden spoons (set of 3) 30 - 35 - 40 cm pack: 1
	34.00093 ξύλινες κουτάλες (σετ 3) wooden spoons (set of 3) 20 - 24 - 30 cm pack: 12
	34.00092 ξύλινες σπάτουλες (σετ 3) wooden spatulas (set of 3) 30 cm pack: 12
	34.00094 2 ξύλινες κουτάλες και σπάτουλα 2 wooden spoons and spatula 30 cm pack: 12





ξύλινα εργαλεία κουζίνας | wooden itchen utensils

	de Buyer ξύλινη σπάτουλα κρέπας στρογγυλή round crepe dough spreader *25.00804 16/1,5 cm   20,5 cm 4873.01 pack: 1
	de Buyer ξύλινη σπάτουλα κρέπας crepe dough spreader *25.00646 16/3 cm   20 cm 4873.02 pack: 1





σειρά θερμικής αντοχής - PA heat resistant line

	+210°C Nylon PA 66 + 30% glass fibers 04.00331 κουτάλα σερβιρίσματος serving spoon 30 cm pack: 1
	04.00330 κουτάλα σούπας soup ladle 30 cm pack: 1
	04.00332 κουτάλα με τρυπητή cooking slotted spoon 30 cm pack: 1
	04.00328 σπάτουλα   turner 30 cm pack: 1
	04.00329 σπάτουλα τρυπητή slotted spatula 30 cm pack: 1
	04.00327 σπάτουλα   spatula 30 cm pack: 1



λαβίδες | tongs

	HENDI λαβίδες st. steel με κλείδωμα st. steel tongs with fastening clip 30.40042 25 cm pack: 1 30.40043 30 cm pack: 1 30.40884 40 cm pack: 1
	HENDI λαβίδες inox/οιλικόνες με μαλακό πιάσιμο και κλείδωμα st. steel tongs with heat resistant silicone tongs and soft-grip with lock 30.40620 24 cm pack: 1 30.40621 30 cm pack: 1 30.42128 44,5 cm pack: 1
	HENDI λαβίδες inox με μαύρη λαβή PVC st. steel tongs with black PVC insulated handle 30.40040 25 cm pack: 1 30.40041 30 cm pack: 1
	HENDI λαβίδες inox με χρωματιστή λαβή PVC st. steel tongs with coloured PVC handle 30.41458 κόκκινη, 25 cm pack: 1 30.41459 μπλε, 25 cm pack: 1 30.41460 πράσινη, 25 cm pack: 1 30.41461 μωβ, 25 cm pack: 1 30.41462 κίτρινη, 25 cm pack: 1 30.42158 καφέ, 25 cm pack: 1 30.41659 κόκκινη, 30 cm pack: 1 30.41660 μπλε, 30 cm pack: 1 30.41661 πράσινη, 30 cm pack: 1 30.41662 μωβ, 30 cm pack: 1 30.41663 κίτρινη, 30 cm pack: 1 30.42159 καφέ, 30 cm pack: 1
	HENDI 30.41439 λαβίδα αλουμινίου φαρδιά, αντικολλητική με κλείδωμα, 28 cm universal tong with teflon coating, 28 cm pack: 1

λαβίδες ανοξείδωτες | tweezers

	30.42255 λαβίδα με κυρτή λαβή <i>tweezer with curved handle</i> 24 cm pack: 1
	30.42256 λαβίδα με στρογγυλή άκρη, st. steel <i>tweezer with round head</i> 30,5 cm pack: 1
	30.42253 λαβίδα με τετραγωνισμένη άκρη <i>tweezer with square head</i> 14,5 cm pack: 1
	30.42254 λαβίδα με κυλινδρική άκρη <i>tweezer with cylindrical head</i> 17 cm pack: 1
	30.42257 λαβίδα με στρογγυλή άκρη, st. steel, μαύρη <i>tweezer with round head, black</i> 30,5 cm pack: 1

	λαβίδες γενικής χρήσης st. steel, κατάλληλες και για τηγαντά <i>multipurpose st. steel tweezers, suitable for e.g. turning deep frying product</i>
	30.41180 16 cm pack: 1
	30.41179 21,5 cm pack: 1
	30.41178 23 cm pack: 1
	30.40143 30 cm pack: 1
	30.42000 μαύρη   black, 30 cm pack: 1

	λαβίδες κυρτές st. steel <i>st. steel curved tweezers</i>
	30.41183 16 cm pack: 1
	30.41182 24 cm pack: 1
	30.41181 30,5 cm pack: 1

	λαβίδες σπαστές sushi st. steel <i>sushi st. steel tweezers</i>
	30.41185 16 cm pack: 1
	30.41184 21 cm pack: 1

	30.41188 λαβίδα με στρογγυλή άκρη, st. steel <i>tweezer with round head</i> 15 cm pack: 1
--	---

	λαβίδες για κόκαλα ψαριών, st. steel <i>fish bone tweezers</i>
	30.41186 12 cm για λεπτά κόκαλα <i>slanted head</i> pack: 1
	30.41187 13 cm για χοντρά κόκαλα <i>flat head</i> pack: 1
	30.42251 10 cm μικρή με ίσια άκρη <i>small flat head</i> pack: 1
	30.42252 15,5 cm με μυτερή άκρη <i>point head</i> pack: 1





λαβίδες σιλικόνης | silicone tweezers

	λαβίδες σιλικόνης, 280°C <i>silicone tweezers, temp up to 280°C</i>
	30.42156 17 cm pack: 1
	30.42157 29 cm pack: 1

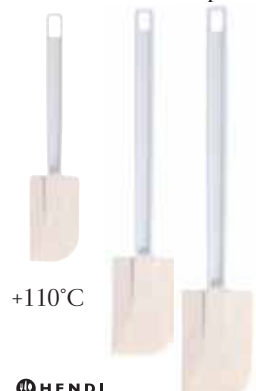

σπάτουλες | *scrapers*

 <p>+110°C</p> <p><b>HENDI</b></p>	<p>σπάτουλες ζύμης (καουτσούκ/ABS) <i>scrapers (synthetic rubber/ABS)</i></p>
	<p>30.40227 7x8x25 cm pack: 1</p>
	<p>30.40228 7x11,5x35 cm pack: 1</p>
<p>30.40229 7x11,5x45 cm pack: 1</p>	

 <p>-60°C +260°C</p> <p><b>HENDI</b></p>	<p>σπάτουλες ζύμης (σιλικόνη/ABS) <i>scrapers (silicone/ABS)</i></p>
	<p>30.40230 7x11,5x25,4 cm pack: 1</p>
	<p>30.40231 7x11,5x35 cm pack: 1</p>
<p>30.40232 7x11,5x45 cm pack: 1</p>	

 <p>+110°C</p>	<p>κουτάλα-ξύστρα (καουτσούκ/ABS) <i>scraper spoon shaped (synthetic rubber/ABS)</i></p>
	<p>30.42042 5,7x8,8 cm   25,4 cm pack: 1</p>
	<p>30.42043 7,5x11,7 cm   35,7 cm pack: 1</p>
	<p>30.40233 7,5x11,7 cm   40,8 cm pack: 1</p>

σπάτουλες-κουτάλες | *spatulas-kitchens spoons*

 <p><b>HENDI</b></p>	<p>30.40172 σπάτουλα αντικολλητική PA, μαύρη (+200°C) <i>non-stick spatula, PA, black (+200°C)</i> 28 cm pack: 1</p>
---	--

 <p>-40°C - +220°C</p> <p><b>HENDI</b></p>	<p>κουτάλα PBT   <i>kitchen spoon PBT</i></p>
	<p>30.41124 7x38 cm pack: 1</p>
	<p>30.41125 8x45 cm pack: 1</p>
	<p>30.40226 10,5x60 cm pack: 1</p>

σπάτουλες | *scrapers*

 <p>de Buyer</p>	<p>σπάτουλες ζύμης από καουτσούκ <i>rubber flexible scraping spatula, 100°C</i></p>
	<p>25.00218 29 cm 4891.24N pack: 1</p>
	<p>25.00069 37,3 cm 4891.34N pack: 1</p>

 <p>de Buyer</p>	<p>σπάτουλες ζύμης σιλικόνης <i>one-piece spatula, high temperature +260°C - nylon handle and silicone blade</i></p>
	<p>25.00215 27 cm 4740.24N pack: 1</p>
	<p>25.00116 42 cm 4740.42N pack: 1</p>

 <p>de Buyer</p>	<p>σπάτουλα polyglass λευκή, +220°C <i>white spatula made of polyglass</i></p>
	<p>25.00216 25 cm 4745.25 pack: 1</p>
	<p>25.00165 30 cm 4745.30 pack: 1</p>
	<p>25.00068 40 cm 4745.40 pack: 1</p>
	<p>25.00641 45 cm 4745.45 pack: 1</p>
	<p>25.00126 50 cm 4745.50 pack: 1</p>

παλέτες | *palletes*

 <p>Jale</p>	<p>34.00142 παλέτα οπαστή <i>pallette knife angled, small</i> 23 cm pack: 1</p>
	<p>34.00143 παλέτα οπαστή μυτερή <i>pallette knife, tapered blade</i> 23 cm pack: 1</p>

παλέτες με μεζούρα | *measuring spreader spatula*

 <p>Jale</p>	<p>34.00144 παλέτα με μεζούρα οπαστή <i>measuring spreader spatula with angled blade</i> 36 cm pack: 1</p>
	<p>34.00145 παλέτα με μεζούρα ίσια <i>measuring spreader spatula with straight blade</i> 36 cm pack: 1</p>

	<p>σπάτουλες ψήσιση   <i>turners</i></p> <p>47.34721 μαύρη   <i>black</i>, 10 cm pack: 1</p> <p>47.35419 μαύρη   <i>black</i>, 16 cm pack: 1</p> <p>47.32618 μαύρη   <i>black</i>, 11 cm pack: 1</p> <p>47.38877 μαύρη   <i>black</i>, 16 cm pack: 1</p>		<p>παλέτα flexible   <i>palette flexible</i></p> <p>30.40389 μαύρη   <i>black</i>, 20,3 cm pack: 1</p> <p>30.40390 μαύρη   <i>black</i>, 25 cm pack: 1</p>
	<p>47.34265 σπάτουλα hamburger 6013 μαύρη   <i>black</i>, 12 cm pack: 1</p>		<p>παλέτες ζαχαροπλαστικής   <i>pastry palettes</i></p> <p>47.32614 μαύρη   <i>black</i>, 25 cm pack: 1</p> <p>47.32612 μαύρη   <i>black</i>, 30 cm pack: 1</p> <p>47.34761 μαύρη   <i>black</i>, 36 cm pack: 1</p> <p>47.32617 σπαστή, μαύρη   <i>offset black</i> 20 cm pack: 1</p>
	<p>σπάτουλες γυρίσματος, flexible <i>flexible turners</i></p> <p>30.40224 μαύρη   <i>black</i> 20x7,3 cm pack: 1</p> <p>30.40205 μαύρη   <i>black</i> 32,5x9,5 cm pack: 1</p> <p>30.40225 μαύρη διάτρητη <i>perforated black</i> 21x7,3 cm pack: 1</p>		<p>παλέτες φαρδιές   <i>wide palettes</i></p> <p>47.35722 μαύρη   <i>black</i>, 18 cm pack: 1</p> <p>47.34734 λευκή   <i>white</i>, 18 cm pack: 1</p>
	<p>σπάτουλες γυρίσματος   <i>turners</i></p> <p>30.40047 10x7,6 cm   27,5 cm pack: 1</p> <p>30.40642 14x10,5 cm   30,8 cm pack: 1</p>		<p>παλέτες σπαστές flexible <i>flexible offset palettes</i></p> <p>30.40641 μαύρη   <i>black</i>, 11 cm pack: 1</p> <p>30.40391 μαύρη   <i>black</i>, 20 cm pack: 1</p> <p>30.40388 μαύρη   <i>black</i>, 25 cm pack: 1</p>
	<p>σπάτουλες γυρίσματος st. steel/ξύλο <i>turners, st. steel/wood</i></p> <p>30.40643 12x7,5 cm   28 cm pack: 1</p> <p>30.40644 15x11 cm   30,5 cm pack: 1</p>		<p>σπάτουλα βουτύρου   <i>butter spatula</i></p> <p>47.35447 μαύρη   <i>black</i>, 11 cm pack: 1</p> <p>47.37231 λευκή   <i>white</i>, 11 cm pack: 1</p>
	<p>96.33015 σπάτουλα γυρίσματος st. steel/ξύλο <i>turner, st. steel/wood</i> 24,6 cm pack: 1</p>		<p>30.40302 σπάτουλα βουτύρου οδοντωτή, μαύρη <i>serrated butter spatula, black</i> 11 cm pack: 1</p>
	<p>96.33017 σπάτουλα γυρίσματος st. steel/ξύλο <i>turner, st. steel/wood</i> 27 cm pack: 1</p>		<p>96.33013 σπάτουλα βουτύρου <i>butter spreader</i> 9,1/10,3 cm pack: 1</p>
	<p>30.40046 σπάτουλα-ξύστis <i>scraper</i>, PP/st. steel 8x10,8 cm   25,1 cm pack: 1</p>		<p>96.33014 σπάτουλα st. steel/ξύλο <i>pie server, st. steel/wood</i> 25,5 cm pack: 1</p>
	<p>30.41189 σπάτουλα-ξύστis, st. steel/ξύλο <i>scraper, st. steel/wood</i> 11,8x10,1 cm   25,1 cm pack: 1</p>		
	<p>96.33016 σπάτουλα-ξύστis, st. steel/ξύλο <i>scraper, st. steel/wood</i> 12,7 cm pack: 1</p>		



30.41890

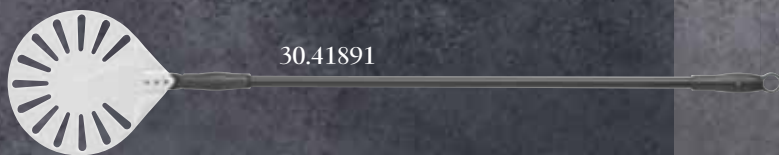

30.41891

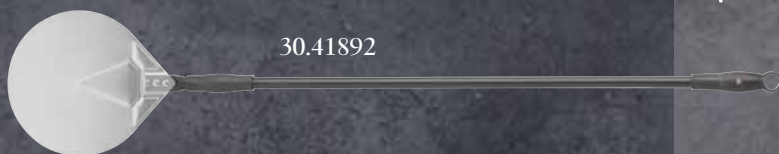

30.41892



30.41893



30.42249



30.41894



30.41895



30.41900



30.40114

## φτυάρια πίτσας | *pizza scoops*

30.41890

στρογγυλό φτυάρι αλουμινίου με αντιολισθητική λαβή  
*round aluminium pizza scoop, handle with slide grip*  
23 cm | 120 cm pack: 1

30.41891

στρογγυλό φτυάρι αλουμινίου, διάτρητο, με αντιολισθητική λαβή  
*round perforated aluminium pizza scoop, handle with slide grip*  
23 cm | 120 cm pack: 1

30.41892

στρογγυλό φτυάρι inox, με αντιολισθητική λαβή  
*round inox pizza scoop, handle with slide grip*  
23 cm | 120 cm pack: 1

30.41893

στρογγυλό φτυάρι inox, διάτρητο, με αντιολισθ. λαβή  
*round perforated inox pizza scoop, handle with slide grip*  
23 cm | 120 cm pack: 1

30.42249

στρογγυλό φτυάρι από σκληρό ανοδιωμένο αλουμίνιο, διάτρητο, με αντιολισθητική λαβή  
*round, hard anodised aluminium, perforated pizza scoop, handle with slide grip*  
23 cm | 120 cm pack: 1

30.41894

τετράγωνο φτυάρι αλουμινίου  
*squared aluminium pizza scoop*  
30,5 cm | 132 cm pack: 1

30.41895

τετράγωνο φτυάρι αλουμινίου  
*squared aluminium pizza scoop*  
40,5 cm | 132 cm pack: 1

30.41900

βούρτσα φούρνου με ορειχάλκινες τρίχες, ξύστρα και κοντάρι αλουμινίου  
*pizza oven cleaning brush, copper brush, aluminium handle*  
132 cm pack: 1

30.40114

βούρτσα/ξύστρα φούρνου με ορειχάλκινα νήματα, ατσάλινη ξύστρα και ξύλινο κοντάρι  
*pizza oven cleaning brush made of brass wire and wooden handle ended with a screw*  
26x93 cm pack: 1



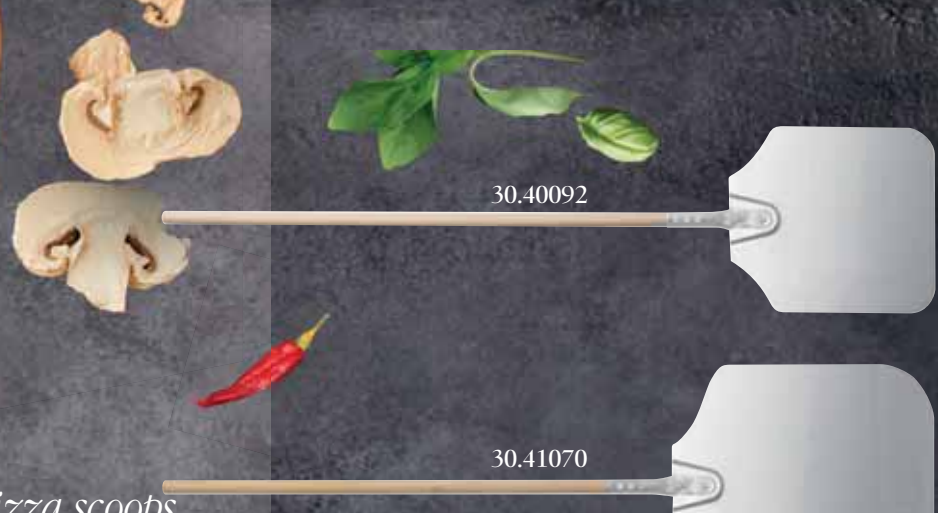

## φτυάρια πίτσας | *pizza scoops*

τετράγωνα φτυάρια αλουμ. με ξύλινη λαβή  
*squared alum. pizza scoop, wooden handle*

- 30.40092  
30,5 cm | 132 cm pack: 1
- 30.42241  
35,5 cm | 132 cm pack: 1
- 30.41070  
40,5 cm | 132 cm pack: 1



30.41898  
τετράγωνο φτυάρι inox  
*squared inox pizza scoop*  
30,5 cm | 132 cm pack: 1



τετράγωνα φτυάρια αλουμινίου διάτρητα  
*squared aluminium pizza scoops, perforated*

- 30.41896  
30,5 cm | 132 cm pack: 1
- 30.41897  
40,5 cm | 132 cm pack: 1



τετράγωνα φτυάρια αλουμινίου διάτρητα, κοντή λαβή  
*squared aluminium pizza scoops, perforated, short handle*

- 30.42245  
30,5 cm | 56 cm pack: 1
- 30.42246  
30,5 cm | 66 cm pack: 1



τετράγωνα φτυάρια από σκληρό ανοδιωμένο αλουμίνιο  
διάτρητα, κοντή λαβή  
*squared, hard anodised aluminium pizza scoops,  
perforated, short handle*

- 30.42247  
30,5 cm | 56 cm pack: 1
- 30.42248  
30,5 cm | 66 cm pack: 1



τετράγωνα φτυάρια αλουμ. με ξύλινη κοντή λαβή  
*squared alum. pizza scoop, wooden short handle*

- 30.42242  
30,5 cm | 66 cm pack: 1
- 30.42243  
35,5 cm | 71 cm pack: 1
- 30.42244  
40,5 cm | 76 cm pack: 1

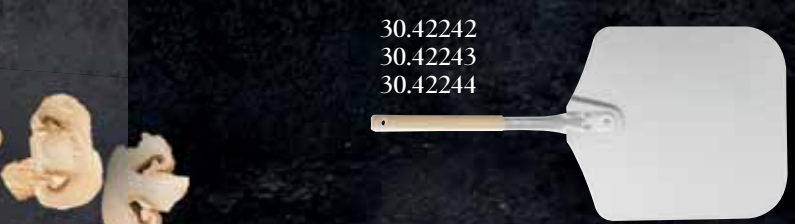
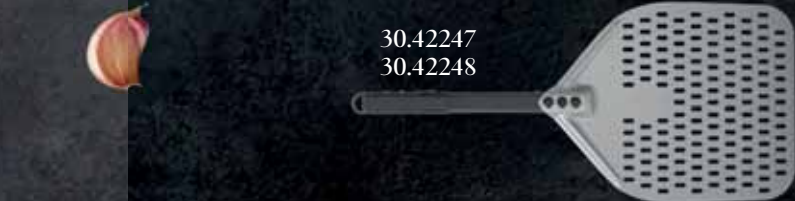

δοχεία ζύμης | *pizza dough boxes*

30.41222 60x40 cm | 7,5 cm  
pack: 1

30.41223 60x40 cm | 9,5 cm  
pack: 1

30.41463 60x40 cm | 13 cm  
pack: 1

30.41464 καπάκι | *lid*  
60x40 cm  
pack: 1



30.40128  
ρόδα/μαχαίρι pizza | *pizza slicer*  
10x23 cm  
pack: 1



30.40060  
σπάτουλα  
*spatula*, 26 cm  
pack: 1



30.40157  
σπάτουλα  
*spatula*, 28x7,5 cm  
pack: 1



τοάντα μεταφοράς πίτσας, μαύρη, από πολυεστέρα.  
με velcro, μεγάλη λαβή και διαφανή τσέπη  
*Thermal insulation delivery bags from durable and  
easy to clean polyester, closed with velcro, large  
handle and top transparent pocket*

30.42259  
για 4 κουτιά 35x35 cm  
*fits 4 boxes of 35x35 cm.*  
36x36 cm | 20 cm  
pack: 1

30.42258  
για 4 κουτιά 45x45 cm  
*fits 4 boxes of 45x45 cm.*  
46x46 cm | 21 cm  
pack: 1





ταψιά πίτσας αλουμινίου  
*aluminium pizza pans*



30.41901  
λαβίδα ταψιού  
*pan gripper*  
19 cm  
pack: 1

96.70003	20 cm	pack: 1
96.70004	28 cm	pack: 1
96.70005	30 cm	pack: 1
96.70006	32 cm	pack: 1
96.70007	36 cm	pack: 1
96.70008	38 cm	pack: 1

30.41899  
λαβίδα ταψιού  
*pan gripper*  
20 cm  
pack: 1



σχάρες πίτσας  
*pizza screens*



30.41879	23 cm	pack: 1
30.41880	25 cm	pack: 1
30.41881	28 cm	pack: 1
30.41085	30 cm	pack: 1
30.41882	33 cm	pack: 1
30.41883	36 cm	pack: 1
30.41876	38 cm	pack: 1
30.41884	40 cm	pack: 1
30.41877	43 cm	pack: 1
30.41885	45 cm	pack: 1
30.41878	48 cm	pack: 1
30.41886	50 cm	pack: 1
30.41887	60 cm	pack: 1

30.41888  
βάση για 14 ταψιά ή  
δίσκους πίτσας  
*pizza screen / pan rack,*  
14 slots,  
30x30,5 cm | 68 cm  
pack: 1











## κόπτης ζύμης | *dough scrapers*

	47.38776	κόπτης ζύμης με καμπύλη λευκός <i>dough scraper curved, white</i> 14 cm pack: 1
	30.40142	κόπτης ζύμης ευθύς <i>dough scraper straight</i> 15x11 cm pack: 1
	30.40073	κόπτης ζύμης ευθύς <i>dough scraper straight</i> st. steel, 15x11 cm pack: 1
	*25.40047	κόπτης μαλακός, χέρι PP <i>soft scraper PP handle</i> 11,5x11 cm pack: 1
	30.40074	σετ 3 κόπτες ζύμης ευθείς <i>set 3 dough scrapers straight</i> 22x13 cm pack: 1
	30.40075	σετ 6 κόπτες ζύμης ευθείς <i>set 6 dough scrapers straight</i> 12x10 cm pack: 1
	30.40076	σετ 6 κόπτες ζύμης flexible <i>set 6 flexible dough scrapers</i> 12x9 cm pack: 1
	10.50025	σετ 2 χούφτες μαλακές PP κόπτης 15x10 cm χτένι διπλής όψης 11x7,5cm <i>set of 2 soft spatulas</i> <i>scraper 15x10 cm</i> <i>comb 11x7,5cm</i> pack: 1
	34.00159	σετ 3 χούφτες σκληρές οδοντωτές <i>set of 3 scrapers</i> 13,5x10 cm pack: 6



## ρόδες κοπής φύλλου | *grating rollers*

	κόπτης ζύμης για κρουασάν ξύλινος <i>croissant roller cutter, wooden handle.</i> *25.40045 croissant, 35 cm pack: 1 *25.40044 mini-croissant, 44 cm pack: 1	
	19.39013	ρόδα κοπής, inox <i>pastry wheel</i> 4 cm pack: 1
	19.39014	ρόδα κοπής οδοντωτή, inox <i>serrated pastry wheel</i> 6 cm pack: 1
	19.39012	διπλή ρόδα κοπής, inox <i>double pastry wheel</i> 6 cm pack: 1
	10.90059	ρόδα κοπής, inox <i>pastry wheel</i> pack: 1
	30.41615	ρόδα κοπής «καρφιά» <i>grating roller spiked</i> 6x20 cm pack: 1
	30.41438	πιτσσομένος κόπτης με 5 ίσιες ρόδες πλάτος κοπής: 5,6-51,5 cm <i>5 wheel dough cutter</i> <i>cutting width: 5,6-51,5 cm</i> 22,2x5,6 cm pack: 1
	30.40298	ρόδα κοπής οδοντωτή, <i>serrated pastry wheel, inox</i> 6 cm pack: 1

πλάστες | *rolling pins*

	30.40077 πλάστρος st. steel με ρουλεμάν <i>st. steel rolling pin with slide bearings</i> 6,5x25/47 cm   1,8 Kgr pack: 1
	30.40078 πλάστρος, inox με ρουλεμάν, βάση και αντιολισθητική επιφάνεια <i>st. steel rolling pin, non-stick coating, with slide bearings, including chrome-plated storage stand</i> 6,5x25/47 cm   1,65 Kgr pack: 1
	πλάστες αντικολλητικοί πλαστικοί <i>non-stick plastic rolling pins</i> 35.00842 3,6 cm   23 cm pack: 1/6 35.01664 3,6 cm   49 cm pack: 1/6
	30.40079 πλάστρος, ξύλινος με ρουλεμάν   <i>wooden rolling pin with ball bearings</i> 7,5x38/59 cm   1,6 Kgr pack: 1
	πλάστρος ξύλινος 35.01369 πλάστρος από ξύλο οξιάς <i>solid beech wood rolling pin</i> 40 cm pack: 1
	πλάστρος από ξύλο οξιάς ρυθμιζόμενος (5 ύψη) <i>beechwood revolving adjustable rolling pin</i> (1-2-3-4-5 mm) 10.50022 54 cm pack: 1



πινέλα | *brushes*

	de Buyer +260°C 25.00321 πινέλο οιλικόννης οβάλ με πυκνή τρίχα <i>large silicone pastry brush with wider and thicker brush</i> 4807.60N 1,4x3 cm   25 cm pack: 1
	πινέλα οιλικόννης για απόλυτη υγιεινή και εύκολο καθαρισμό <i>silicon hygienic brush, easily cleanable</i> 25.00030 3 cm   19,5 cm 4807.00 pack: 1 25.00356 3 cm   25 cms 4807.25 pack: 1 25.00031 6 cm   25 cm 4807.50 pack: 1
	πινέλα λίπους <i>butter and fat brushes with st. steel bristles</i> 30.41436 2,5 cm pack: 1 30.41437 5 cm pack: 1
	πινέλα οιλικόννης <i>butter and fat brush flat silicone</i> 30.42280 3,2 cm   22 cm pack: 1 30.42127 4,5 cm   23 cm pack: 1

scoops

	30.40070 scoop λαδιού   <i>oil scoop</i> 22,5 cm pack: 1
	35.00051 scoop αντικολλητικό, με αντιψυκτικό υγρό <i>scoop with non-stick coating and non-freeze gel</i> 18 cm pack: 1/6
	34.60080 scoop, inox 12 scoops/litre μεταδίδει τη θερμοκρασία της παλάμης pack: 6
	19.21004 scoop, inox τριγωνικό <i>ice cream scoop</i> 4,1 cm pack: 1/12
	30.40278 scoop, μπλε   <i>blue</i> 26 cm pack: 1

αυγοδάρτες βαριάς χρήσης | *heavy duty whisks*



- αντιβακτηριαδικός • απόλυτη υγιεινή • αποστειρώνεται
- αντιολισθητική λαβή για να μην επιτρέψει το πέσιμο στο μπολ
- 2 τρόποι χρήσης.
- professional whisk • Perfectly hygienic • Can be sterilized
- Anti-slip handle with curved design: the whisk will not fall into the pan
- 2 possibilities to use the whisk

de Buyer



25.00114	25 cm
2610.25	pack: 1
25.00032	30 cm
2610.30	pack: 1
25.00033	35 cm
2610.35	pack: 1
25.00034	40 cm
2610.40	pack: 1
25.00035	45 cm
2610.45	pack: 1

αυγοδάρτες | *whisks*



αυγοδάρτες βαριάς χρήσης, st. steel με λαβή PP, με 8 χοντρά σύρματα  
*heavy duty whisks with PP handle and 8 heavy stiff wires*

30.41633	25 cm
	pack: 1
30.41634	35 cm
	pack: 1
30.41635	45 cm
	pack: 1



αυγοδάρτες st. steel, με λαβή PP με 12 εύκαμπτα σύρματα  
*st. steel whisks with PP handle with 12 flexible piano wires*

30.41190	20 cm
	pack: 1
30.41191	25 cm
	pack: 1
30.41192	35 cm
	pack: 1
30.41193	40 cm
	pack: 1
30.41194	45 cm
	pack: 1



αυγοδάρτες βαριάς χρήσης, st. steel με 8 χοντρά σύρματα  
*heavy duty whisks with 8 heavy stiff wires*

30.41071	25 cm
	pack: 1
30.41821	30 cm
	pack: 1
30.40036	35 cm
	pack: 1
30.40037	40 cm
	pack: 1
30.40038	50 cm
	pack: 1
30.41822	60 cm
	pack: 1



αυγοδάρτες, st. steel με 7 εύκαμπτα σύρματα  
*st. steel whisks with 7 flexible piano wires*

30.41072	20 cm
	pack: 1
30.40034	25 cm
	pack: 1
30.40035	35 cm
	pack: 1



30.42216 αυγοδάρτης καθαρόλας  
*dressing and pan whisk*  
16 cm  
pack: 1



30.42217 αυγοδάρτης σπιράλ  
*spiral whisk*  
26 cm  
pack: 1



30.40158 αυγοδάρτης καθαρόλας  
*dressing and pan whisk*  
16 cm  
pack: 1



25.00373 αυγοδάρτης σφαιρικός επαγγελματικός  
*professional whisk has a large head and hard springy wires for beating eggwhites*  
35 cm  
pack: 1



επιφάνειες ψησίματος | *non-stick baking mats*

HENDI

επιφάνειες ψησίματος σιλικόνης  
*silicon non-stick baking mat*

30.40293 30x40 cm | 7 mm  
pack: 1

30.40291 53x32,5 cm | 7 mm  
pack: 1

30.40292 60x40 cm | 7 mm  
pack: 1

250°C



βάσεις διακόσμησης | *decoration stands*



34.00141 βάση τούρτας, περιστρεφόμενη, και υπό γωνία 0-20°  
*cake stand, rotating the top can be adjusted to any angle between 0-20°*  
25 cm | 9 cm  
pack: 1



35.02165 stand για 24 pop up cakes  
*stand for pop up cakes*  
29x16 cm | 9 cm  
pack: 1

λαδόχαρτο | *greaseproof paper*



34.00147 λαδόχαρτο (20 φύλλα)  
*greaseproof paper (20 pcs)*  
34x27 cm  
pack: 1

34.00148 λαδόχαρτο (20 φύλλα)  
*greaseproof paper (20 pcs)*  
23 cm  
pack: 1

επιφάνειες ψησίματος | *non-stick baking mats*

*Air Mat*

silikowart  
professional



14.10066 40.111.99.0000

«Air Mat éclair»  
επιφάνεια ψησίματος σιλικόνης  
διπλής όψης  
*double use silicone mat*  
58,3x38,4 cm  
pack: 1



silikowart  
professional

νέο  
προϊόν



14.10067 40.112.99.0000

«Air Mat Choux»  
επιφάνεια ψησίματος σιλικόνης  
διπλής όψης  
*double use silicone mat*  
58,3x38,4 cm  
pack: 1



βάσεις διακόσμησης | *decoration stands*

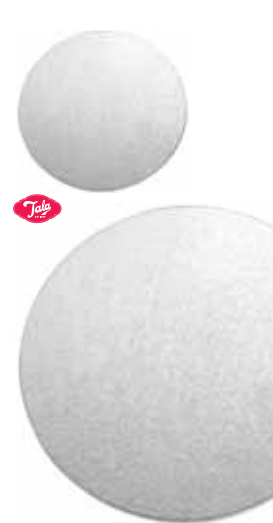

βάσεις τούρτας με αλουμινόχαρτο  
στρογγυλές | *round cake drum*

34.00157 20 cm | 0,3 cm  
pack: 1

34.00149 20 cm | 1,2 cm  
pack: 1

34.00158 25 cm | 0,3 cm  
pack: 1

34.00150 25 cm | 1,2 cm  
pack: 1

34.00151 30 cm | 1,2 cm  
pack: 1

34.00152 35 cm | 1,2 cm  
pack: 1



βάσεις τούρτας με αλουμινόχαρτο  
τετράγωνα | *square cake drum*

34.00161 25x25 cm | 0,3 cm  
pack: 1

34.00154 25x25 cm | 1,2 cm  
pack: 1

34.00162 30x30 cm | 0,3 cm  
pack: 1

34.00155 30x30 cm | 1,2 cm  
pack: 1

34.00156 35x35 cm | 1,2 cm  
pack: 1



Έμπνευση, δημιουργικότητα και όραμα... τα εργαλεία



**HENDI**

30.41159  
ραβδομπλέντερ «Concept line»  
σχεδιάστηκε υπό του  
Robert Bronwasser ειδικά για σεφ.  
περίβλημα από πλαστικό ABS  
με άξονα από ανοξείδωτο ατσάλι.  
Λεπίδα από ανοξείδωτο ατσάλι  
με επίστρωση τιτανίου  
ισχυρός κινητήρας 250W,  
6 ταχύτητες - ενδείξεις LCD  
μέγιστη ταχύτητα: 13.500 rpm.  
Κατάλληλο για παρασκευή ποσοτήτων  
από 1 έως 4 λίτρα.

*Stick blender «Concept line»  
Designed with chefs  
in mind by Robert Bronwasser.  
ABS plastic housing and a stainless steel shaft.  
Stainless steel cross shaped blade with titanium  
coating. Powerful 250W motor,  
6 speeds with LCD display.  
Maximum speed 13500 rpm.  
Suitable for processing 1 to 4 liters.  
7,1 cm | 44,4 cm  
pack: 1*



30.41731  
φλόγιτρο | *sburner*  
18,5x6,5 cm | 10 cm  
pack: 1

**HENDI**



30.40673  
φιάλη αερίου  
200 ml  
*gas canister*  
pack: 1

**HENDI**



30.40674  
φόρμα crème brûlée  
*ramekin*  
10 cm | 2,5 cm  
pack: 1/12



30.40671  
σετ 4 φιάλες αερίου  
*set of 4 cartridges, 227g*  
pack: 1



**HENDI**

30.40672  
φλόγιτρο  
*crème-brûlée burner*  
11,5 cm | 15,5 cm  
pack: 1



**HENDI**

30.40192  
φλόγιτρο  
*crème-brûlée burner*  
14,5 cm | 19 cm  
pack: 1/6



DIMITRIS CHRONOPOULOS

*Pastery Chef*

που απογειώνουν τη σύγχρονη ζαχαροπλαστική

ΚΟΥΖΙΝΑ

415

ΖΑΧΑΡΟΠΛΑΣΤΙΚΗ



de Buyer

σακούλες από πλαστικοποιημένο βαμβάκι χωρίς ραφές  
*coated cotton pastry bags*

25.00071 40 cm  
4856.40 pack: 1



HENDI

30.40685  
σακούλες αντικολλητικές βιοδιασπώμενες για ζεστά και κρύα,  
*biodegradable disposable bags, for hot and cold, polyethylene 80 micron*  
51,5x28 cm (100 τμχ.)  
pack: 1



HENDI

σακούλες για ζεστά και κρύα,  
*80 micron polyethylene pastry bags, for hot and cold*

30.40684 44,5x22 cm (100 τμχ.)  
pack: 1

30.40683 53x28,5 cm (100 τμχ.)  
pack: 1

σετ 2 βαμβακερές σακούλες, εσωτερικά πλαστικοποιημένες με πολυουρεθάνη, πολύ ανθεκτικές  
*set of 2 heavy duty pastry bags, cotton, inside coated with polyurethane*

HENDI

30.40678 35 cm  
pack: 1

30.40679 40 cm  
pack: 1

30.40680 45 cm  
pack: 1

30.40681 50 cm  
pack: 1



HENDI

30.41838  
επιτοίχια βάση για 4 σακούλες και 31 μύτες και 7 άγκιστρα,  
*wall rack for 4 hanging bags, 31 icing tips, and 7 hooks to hang tools*  
49,5x34 cm | 56,5 cm  
pack: 1







μύτες ζαχαροπλαστικής | *pastry nozzles*

<p><b>HENDI</b></p>	<p>30.40676 σετ 5 μύτες, st. steel set of 5 pastry nozzles 6, 8, 10, 12, 14 mm pack: 1</p>
<p><b>HENDI</b></p>	<p>30.40675 σετ 5 μύτες κυματιστές, st. steel set of 5 serrated nozzles 6, 8, 10, 12, 14 mm pack: 1</p>
<p><b>HENDI</b></p>	<p>30.40540 σετ 5 μύτες, st. steel γεμίσματος - μακαρόν - ντεκόρ - κυματισμού καλαθιού - 1 γραψίματος set of 5 pastry nozzles filling - macarons - writing decorating - basket weave pack: 1</p>
	<p>30.41465 σετ 5 μύτες st. steel «λουλούδια και πέταλα» 2 σταγόνες λουλουδιών - 1 άκρη αστεριού - 1 άκρη πέταλου - 1 ομαλή άκρη set of 5 pastry nozzles "flowers and petal" 2 drop flower tips - 1 open star tip - 1 petal tip - 1 small smooth tip pack: 1</p>
<p><b>HENDI</b></p>	<p>30.40072 σετ 7 μύτες απλές, PP set of 7 pastry nozzles, PP 4, 6, 8, 10, 12, 14, 16 mm pack: 1</p>
<p><b>HENDI</b></p>	<p>30.40206 σετ 7 μύτες κυματιστές, PP set of 7 serrated nozzles, PP 8, 10, 12, 14, 16, 18, 20 mm pack: 1</p>
<p><b>de Buyer</b></p> <p><b>HACCP</b></p>	<p>25.00297 4347.10 σταντ PP για σακούλες ζαχαροπλαστικής holder for pastry bag, PP 19,5 mm   23 cm pack: 1</p>





<p>25.00698 2112.02N</p>	<p>0,3 cm   A5 pack: 1</p>
<p>25.00699 2112.03N</p>	<p>0,3 cm   A6 pack: 1</p>
<p>25.00700 2112.04N</p>	<p>0,35 cm   A7 pack: 1</p>
<p>25.00701 2112.05N</p>	<p>0,5 cm   A8 pack: 1</p>
<p>25.00702 2112.06N</p>	<p>0,5 cm   B5 pack: 1</p>
<p>25.00703 2112.07N</p>	<p>0,5 cm   B6 pack: 1</p>
<p>25.00704 2112.08N</p>	<p>0,6 cm   B7 pack: 1</p>
<p>25.00551 2112.09N</p>	<p>0,7 cm   B8 pack: 1</p>
<p>25.00705 2112.10N</p>	<p>0,7 cm   C5 pack: 1</p>
<p>25.00706 2112.11N</p>	<p>0,7 cm   C6 pack: 1</p>
<p>25.00707 2112.12N</p>	<p>0,7 cm   C7 pack: 1</p>
<p>25.00708 2112.13N</p>	<p>0,9 cm   C8 pack: 1</p>
<p>25.00709 2112.14N</p>	<p>1,1 cm   D5 pack: 1</p>
<p>25.00710 2112.15N</p>	<p>1,1 cm   D6 pack: 1</p>
<p>25.00552 2112.16N</p>	<p>1,1 cm   D7 pack: 1</p>
<p>25.00711 2112.17N</p>	<p>1,1 cm   D8 pack: 1</p>
<p>25.00712 2112.18N</p>	<p>1,3 cm   E5 pack: 1</p>
<p>25.00713 2112.19N</p>	<p>1,3 cm   E6 pack: 1</p>
<p>25.00553 2112.20N</p>	<p>1,3 cm   E7 pack: 1</p>
<p>25.00714 2112.21N</p>	<p>1,3 cm   E8 pack: 1</p>
<p>25.00715 2112.22N</p>	<p>1,8 cm   F5 pack: 1</p>
<p>25.00554 2112.23N</p>	<p>1,8 cm   F6 pack: 1</p>
<p>25.00716 2112.24N</p>	<p>1,8 cm   F7 pack: 1</p>
<p>25.00717 2112.25N</p>	<p>1,8 cm   F8 pack: 1</p>

	<b>25.00682</b> 0,2 cm   5 cm 2111.02N pack: 1
	<b>25.00683</b> 0,3 cm   5 cm 2111.03N pack: 1
	<b>25.00547</b> 0,4 cm   5 cm 2111.04N pack: 1
	<b>25.00684</b> 0,5 cm   5 cm 2111.05N pack: 1
	<b>25.00685</b> 0,6 cm   5 cm 2111.06N pack: 1
	<b>25.00686</b> 0,7 cm   4,5 cm 2111.07N pack: 1
	<b>25.00687</b> 0,8 cm   4,5 cm 2111.08N pack: 1
	<b>25.00688</b> 0,9 cm   4,5 cm 2111.09N pack: 1
	<b>25.00689</b> 1 cm   5,4 cm 2111.10N pack: 1
	<b>25.00690</b> 1,1 cm   5 cm 2111.11N pack: 1
	<b>25.00548</b> 1,2 cm   5 cm 2111.12N pack: 1
	<b>25.00691</b> 1,3 cm   5 cm 2111.13N pack: 1
	<b>25.00692</b> 1,4 cm   5 cm 2111.14N pack: 1
	<b>25.00693</b> 1,5 cm   5,4 cm 2111.15N pack: 1
	<b>25.00549</b> 1,6 cm   5,3 cm 2111.16N pack: 1
	<b>25.00694</b> 1,7 cm   5,3 cm 2111.17N pack: 1
	<b>25.00695</b> 1,8 cm   5 cm 2111.18N pack: 1
	<b>25.00696</b> 2 cm   5 cm 2111.20N pack: 1
	<b>25.00550</b> 2,2 cm   4,9 cm 2111.22N pack: 1
	<b>25.00697</b> 2,4 cm   4,5 cm 2111.24N pack: 1

	<b>25.00725</b> 7 mm   4,8 cm 2116.07 10 δόντια   10 teeth pack: 1
	<b>25.00726</b> 7 mm   4,3 cm 2116.08 12 δόντια   12 teeth pack: 1
	<b>25.00727</b> 10 mm   5 cm 2116.10 14 δόντια   14 teeth pack: 1
	<b>25.00728</b> 14 mm   5,5 cm 2116.14 16 δόντια   16 teeth pack: 1
	<b>25.00729</b> 16 mm   5,3 cm 2116.16 17 δόντια   17 teeth pack: 1
	<b>25.00730</b> 17,5 mm   4,8 cm 2116.17 18 δόντια   18 teeth pack: 1



	<b>25.00735</b> 4,5 mm - ίσια   plain 2118.31 pack: 1
	<b>25.00734</b> 4,5 mm - σιτέρι   star 2118.12 pack: 1

	<b>25.00731</b> 21/35 mm   6,3 mm 2118.01 προεξέχων κώνος protruding cone pack: 1
	<b>25.00732</b> 21/35 mm   6,3 mm 2118.02 flat cone-up pack: 1

	<b>25.00733</b> 7 mm (12 δόντια 2118.03 (12 teeth) pack: 1
--	--

	<b>25.00555</b> 16x2 mm (6 points) 2113.06N pack: 1
	<b>25.00718</b> 20x3 mm (6 points) 2113.08N pack: 1

	<b>25.00749</b> 0,8 cm   5 cm 2129.08N pack: 1
	<b>25.00750</b> 0,9 cm   5 cm 2129.09N pack: 1
	<b>25.00751</b> 1,1 cm   5 cm 2129.11N pack: 1
	<b>25.00599</b> 1,4 cm   5 cm 2129.14N pack: 1
	<b>25.00752</b> 1,6 cm   5 cm 2129.16N pack: 1

	<b>25.00748</b> No 2 large 6 mm 2128.02N pack: 1
---	---





*st. steel Bird nest nozzle*

de Buyer

	<b>25.00745</b> 1,3 cm   3,95 cm 2126.00N (7 τρύπες   holes) pack: 1
	<b>25.00746</b> 1,9 cm   3,95 cm 2126.01 (9 τρύπες   holes) pack: 1

*st. steel spiral effect nozzle*

de Buyer

	<b>25.00736</b> 3,1 cm   4,15 cm 2119.13 (8 δόντια   teeth) pack: 1
--	---

*st. steel Bird nest nozzle*

de Buyer

	<b>25.00747</b> 3,1 cm 2126.02 3 fluted holes pack: 1
--	---

*st. steel ruban nozzle*

de Buyer

	<b>25.00322</b> 10x2 mm (2,5 cm   4,5 cm) 2117.10 pack: 1
	<b>25.00323</b> 15x2 mm (3,2 cm   4,5 cm) 2117.15 pack: 1
	<b>25.00324</b> 20x2 mm (3,2 cm   4,5 cm) 2117.20 pack: 1
	<b>25.00325</b> 30x5 mm (3,6 cm   4,5 cm) 2117.30 pack: 1

*st. steel Saint Honoré nozzle*

de Buyer

	<b>25.00720</b> 0,9 cm   5,5 cm 2115.20N pack: 1
	<b>25.00721</b> 1,1 cm   5,3 cm 2115.25N pack: 1
	<b>25.00722</b> 1,3 cm   5,3 cm 2115.30N pack: 1
	<b>25.00723</b> 1,5 cm   5,3 cm 2115.35N pack: 1
	<b>25.00724</b> 1,6 cm   5,3 cm 2115.40N pack: 1

*st. steel Russian nozzles*

de Buyer

	<b>25.00737</b> 2,67 mm   3,85 cm 2120.01 No 241 pack: 1
	<b>25.00738</b> 2,67 mm   3,85 cm 2120.02 No 242 pack: 1
	<b>25.00556</b> 2,67 mm   3,85 cm 2120.03 No 243 pack: 1
	<b>25.00739</b> 2,67 mm   3,85 cm 2120.04 No 244 pack: 1
	<b>25.00740</b> 2,67 mm   3,85 cm 2120.05 No 244 pack: 1
	<b>25.00557</b> 2,67 mm   3,85 cm 2120.06 No 247 pack: 1
	<b>25.00558</b> 2,67 mm   3,85 cm 2120.08 No 248 pack: 1
	<b>25.00741</b> 2,67 mm   3,85 cm 2120.07 No 257 pack: 1

*st. steel Sphere nozzle*

de Buyer

	<b>25.00742</b> λεπτές ραβδώσεις 2120.20 fine streaks pack: 1
	<b>25.00743</b> φαρδιές ραβδώσεις 2120.21 large streaks pack: 1

*st. steel garnishing nozzles*

de Buyer

	<b>25.00268</b> 6 mm   8,2 cm 2125.06 pack: 1
	<b>25.00744</b> σετ 3 μύτες 2125.03 set of 3 nozzles 4-6-8 mm pack: 1

*προσαρμογείς για μύτες | adapter for nozzles*

de Buyer

	<b>25.00719</b> σετ 3 προσαρμογείς 2114.13 set of 3 adapters for 3 sizes of nozzles 35/25/20 mm pack: 1
--	---

μύτες ζαχαροπλαστικής | *pastry nozzles*

de Buyer

25.00267  
2114.20



μύτες διακόσμησης  
σετ με 26 μύτες  
και 2 προσαρμογείς  
αλλαγής μύτες χωρίς  
να αλλάζετε σακούλα,  
ιδανικές για  
διακόσμηση σοκολάτας,  
κρέμας ή γλασέ  
για γράψιμο ή  
δημιουργία  
φύλλων-λουλουδιών, κ.ά.  
*case with 26 st. steel decor  
noozles  
an adaptator + 2 supports to  
make decorations in choco-  
late/cream/glaze for writing  
or creating leaves, flowers.  
Supplied with an adapter to  
change nozzles on the same  
pastry bag*  
pack: 1



δοσομερτητές | *piston funnels*

κορνέ - σύριγγες διακόσμησης | *icing syringes*



34.20062 κορνέ-σύριγγα  
με 8 μύτες  
*icing syringe, 8 nozzles*  
10 cl  
pack: 6

Jale



\*25.00482 δοσομερτητής, st. steel,  
3354.52 με βάση και δύο μύτες  
ιδανικό για μους, παχιές  
σάλτσες, καραμέλα,  
σοκολάτα, κ.ά.  
*piston funnel with base  
and 2 nozzles. Perfect for  
mousses, thick sauces, sauces  
with fruit pieces, caramel,  
thick jelly or fruit coulis, etc.*  
3,3 lt (20 cm | 38 cm)  
pack: 1

κόπτες τούρτας | *cake cutters*

KitchenCraft



35.00466 σύρμα κοπής  
*cutting wire (20 pcs)*  
23 cm  
pack: 1



30.40669 δοσομερτητής, st. steel,  
με βάση και τρεις μύτες  
4, 5 & 6 mm  
*piston funnel with base  
and 3 nozzles. 4, 5 & 6 mm*  
1,5 lt (27x19,5 cm | 22 cm)  
pack: 1



25.00381 «Kwik» δοσομερτητής  
3353.00 μαύρος, st. steel,  
με βάση & με μύτη 7 mm  
ιδανικό για μικρές ποσό-  
τητες σάλτσας, κρέμας κ.ά.  
*piston funnel black,  
with base and 7 mm nozzle  
ideal for dispensing small  
portions of sauce or cream*  
0,8 lt  
18,5x15 cm | 15,5 cm  
pack: 1



10.50024 «Pinocchio»  
δοσομερτητής μαύρος,  
st. steel,  
με βάση & 3 μύτες  
σιλικόνης 4-6-7,5 mm  
*gauging funnel black,  
with base and 3 silicone  
spouts 4-6-7,5 mm*  
17,8 cm | 23 cm  
pack: 1





### κορνέ - σύριγγες διακόσμησης | *icing tubes*

<p>KitchenCraft</p>	<p>35.00465 σετ 2 φιάλες διακόσμησης με μύτη και καπάκι Pack of 2 easy squeeze icing tubes with fine nozzles and screw caps for icing storage 70 ml pack: 6</p>
---------------------	---

	<p>κουτάλι διακόσμησης με κωνικό χείλος και λαβή σιλικόνης st. steel decorating spoon with a tapered pouring lip silicone handle</p> <p>*25.40051 6,5 cm   25 cm pack: 1</p>
--	--



### εργαλεία σοκολάτας | *chocolate tools*

<p>HENDI</p>	<p>30.42003 μπεν μαρί, st. steel st. steel bain-marie, 1 lt 16 cm   9,5 cm pack: 1</p>
--------------	--

<p>silikonart</p>	<p>14.10096 73.514.99.0062 «Wood» σπάτουλα φύλλων choco leaves spatula 6x4,5 cm pack: 1</p>
-------------------	---

### εργαλεία καραμέλας | *sugar accessories*

<p>de Buyer</p>	<p>κατοσρόλα καραμέλας χάλκινη, συμπαγής με 2 στόμια και ι inox λαβή sugar saucer, massive copper, 2 sprouts and st. steel cold handle</p> <p>*25.00119 3,4 lt 6572.20 20 cm   11 cm pack: 1</p>
-----------------	--

### κουπάτ ζαχαρόπαστας | *fondant plunger cutters*

	<p>κουπάτ ζαχαρόπαστας fondant plunger cutters</p> <p>35.00829 «Flower» σετ 4 τμχ.   set of 4 pieces 3,5 - 2,7 - 1,9 - 1,3 cm pack: 6</p>
--	---

	<p>35.00828 «Star» σετ 3 τμχ.   set of 3 pieces 1,8 - 1,4 - 0,8 cm pack: 6</p>
--	--

### εργαλεία διακόσμησης | *icing tools*

<p>Jale</p>	<p>34.00164 4 εργαλεία διακόσμησης διπλής ακμής icing modelling tools set 4 pcs pack: 1</p>
-------------	---

<p>KitchenCraft</p>	<p>35.01386 σετ 5 πινέλα ζαχαροπλαστικής set of 5 fine bristle brushes pack: 1</p>
---------------------	--

<p>KitchenCraft</p>	<p>35.00899 εργαλείο λείανσης ζαχαρόπαστας icing smoother pack: 1</p>
---------------------	---



de Buyer 

## σύριγγα πίεσης | «Le Tube» pressure pastry syringe

«Le Tube» γαρνίρει, γεμίζει, ντεκοράρει. Για εύκολες δόσεις πάστα, κρέμας και μους. Εργονομική αντιολισθητική λαβή. Διακόπτης ρύθμισης, πίεσης για ακριβή δοσολογία σε cl ή oz. Διάφανος σωλήνας 0,75 lt για εύκολη παρακολούθηση. Σύστημα stop-drop για σταμάτημα της ροής μεταξύ δύο πιέσεων. Με 2 PC μύτες U8 και D8

*Pressure syringe for effortless dosing of paste, creams and mousses. For garnishing, filling and decorating. Simple, fast and accurate work. Easier to fill than a pastry bag. 0,75 L. capacity in transparent plastic. Graduated in cl and oz. Allows the user to see how much is left. Knob for easy setting of pressure for dosing the amount to be poured (from 1 to 5 cl). Removable and interchangeable nozzles.*





**25.00825** «Le Tube»  
3358.01 παραδίδεται με 2 μύτες PC, κιτ μπισκότων (13 δίσκους για μπισκότα) και 2 καπάκια δοχείου για αποθήκευση delivered with 2 PC nozzles, biscuits kit (13 discs) and 2 caps to store the paste 10,5 cm | 38,4 cm pack: 1

**25.00206** έξτρα σωλήνας / δοχείο αποθήκευσης-γέμισης extra tank for storing with lid 8,5 cm | 19,6 cm pack: 1



# Micro perforated baking rings



τοέρκια παραλ. | *rectangular ring*

14.10189 276.20.0165 36 pcs / 60x40 cm  
 σετ 6 τοέρκια τάρτας  
*set 6 tarte rings*  
 12x3,5 cm | 2 cm  
 pack: 1

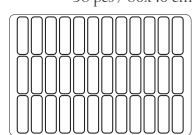

14.10190 390.20.0065 6 pcs / 60x40 cm  
 τοέρκι τάρτας  
*tarte ring*  
 26,5x10,5 cm | 2 cm  
 pack: 1

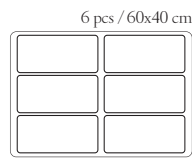

τοέρκια καρδιά | *heart-shaped ring*

14.10075 317.20.0165 30 pcs / 60x40 cm  
 σετ 8 τοέρκια τάρτας  
*set 8 tarte rings*  
 8x7 cm | 2 cm  
 pack: 1



14.10205 407.20.0065 4 pcs / 60x40 cm  
 τοέρκι τάρτας  
*tarte ring*  
 20,5x19 cm | 2 cm  
 pack: 1

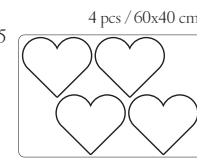

**silikomart®**  
 professional



τοέρκια οβάλ | *ovla ring*

14.10074 287.20.0165 28 pcs / 60x40 cm  
 σετ 6 τοέρκια τάρτας  
*set 6 tarte rings*  
 14,6x3,4 cm | 2 cm  
 pack: 1

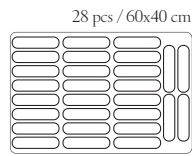

τοέρκια τετράγωνα | *square rings*

14.10073 286.20.0165 24 pcs / 60x40 cm  
 σετ 6 τοέρκια τάρτας  
*set 6 tarte rings*  
 8x8 cm | 2 cm  
 pack: 1

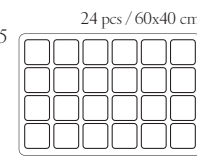

14.10192 388.20.0065 2 pcs / 60x40 cm  
 τοέρκι τάρτας  
*tarte rings*  
 20x20 cm | 2 cm  
 pack: 1

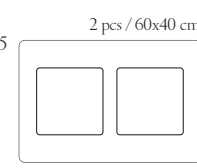

τοέρκια στρογγυλά | *round rings*

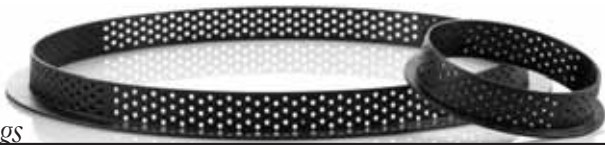

14.10191 306.20.0165 25 pcs / 60x40 cm  
 σετ 8 τοέρκια τάρτας  
*set 8 tarte rings*  
 7 cm | 2 cm  
 pack: 1

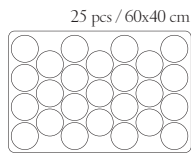

14.10072 285.20.0165 12 pcs / 60x40 cm  
 σετ 4 τοέρκια τάρτας  
*set 4 tarte rings*  
 12 cm | 2 cm  
 pack: 1

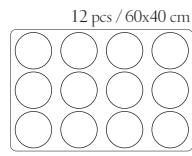

14.10077 385.20.0065 3 pcs / 60x40 cm  
 τοέρκι τάρτας  
*tarte rings*  
 21 cm | 2 cm  
 pack: 1

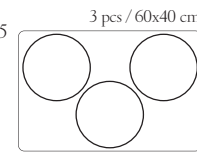

14.10069 243.20.0165 25 pcs / 60x40 cm  
 σετ 6 τοέρκια τάρτας  
*set 6 tarte rings*  
 8 cm | 2 cm  
 pack: 1

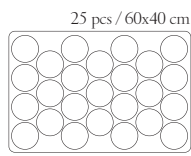

14.10070 244.20.0165 6 pcs / 60x40 cm  
 σετ 2 τοέρκια τάρτας  
*set 2 tarte rings*  
 15 cm | 2 cm  
 pack: 1

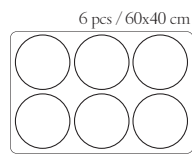

14.10078 386.20.0065 2 pcs / 60x40 cm  
 τοέρκι τάρτας  
*tarte rings*  
 23 cm | 2 cm  
 pack: 1

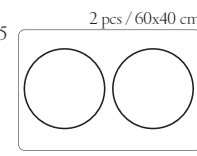

14.10071 277.20.0165 15 pcs / 60x40 cm  
 σετ 4 τοέρκια τάρτας  
*set 4 tarte rings*  
 10 cm | 2 cm  
 pack: 1

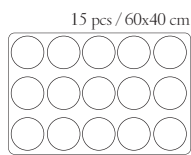

14.10076 369.20.0065 4 pcs / 60x40 cm  
 τοέρκι τάρτας  
*tarte rings*  
 19 cm | 2 cm  
 pack: 1

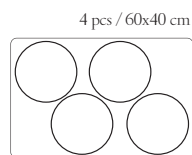

14.10079 387.20.0065 2 pcs / 60x40 cm  
 τοέρκι τάρτας  
*tarte rings*  
 25 cm | 2 cm  
 pack: 1

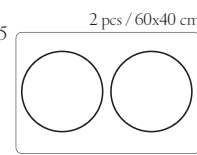

Δημιουργήθηκαν σε συνεργασία με την «Ecole Valrhona». Διάτρητα τσέρκια st. steel που εκπλήσσουν με τις επιδόσεις τους. • Ομοιόμορφο ψήσιμο. • Πανεύκολη απελευθέρωση περιεχομένου • Υψηλό αισθητικό αποτέλεσμα.

*Created in partnership with the «Ecole Valrhona» these new tart st. steel rings with small holes enable an uniform baking of the pie/tart edges. The right edge allows an easy removal and a perfect pastry rim.*



	<p>τσέρκια στρογγυλά, 2 cm ύψος <i>round rings, 2 cm height</i></p> <p><b>*25.00305</b> 5,5 cm   2 cm 3099.01 pack: 1</p> <p><b>*25.00337</b> 6,5 cm   2 cm 3099.02 pack: 1</p> <p><b>*25.00187</b> 10,5 cm   2 cm 3099.04 pack: 1</p> <p><b>*25.00614</b> 12,5 cm   2 cm 3099.05 pack: 1</p> <p><b>*25.00344</b> 15,5 cm   2 cm 3099.06 pack: 1</p> <p><b>*25.00582</b> 18,5 cm   2 cm 3099.07 pack: 1</p> <p><b>*25.00188</b> 20,5 cm   2 cm 3099.08 pack: 1</p> <p>διαθέσιμα επίσης και/ <i>available also:</i> 7,5 - 24,5 - 25,8 cm</p>
	<p>τσέρκια στρογγυλά, 3,5 cm ύψος <i>round rings, 3,5 cm height</i></p> <p><b>*25.00766</b> 12,5 cm   3,5 cm 3098.05 pack: 1</p> <p><b>*25.00767</b> 20,5 cm   3,5 cm 3098.08 pack: 1</p> <p>διαθέσιμα επίσης και/ <i>available also:</i> 5,5 - 6,5 - 7,5 - 8,5 - 10,5 - 15,5 - 24,5 - 28,5 cm</p>

	<p>τσέρκια τετράγωνα, 2 cm ύψος <i>square rings, 2 cm height</i></p> <p><b>*25.00490</b> 7x7 cm   2 cm 3099.19 pack: 1</p> <p><b>*25.00584</b> 15x15 cm   2 cm 3099.21 pack: 1</p> <p><b>*25.00189</b> 20x20 cm   2 cm 3099.22 pack: 1</p> <p>διαθέσιμα επίσης και με ύψος 3,5 cm <i>available also with height 3,5 cm</i></p>
--	--

	<p>τσέρκια ορθογώνια, 2 cm ύψος <i>rectangle rings, 2 cm height</i></p> <p><b>*25.00287</b> 12x4 cm   2 cm 3099.30 pack: 1</p> <p><b>*25.00342</b> 25x8 cm   2 cm 3099.32 pack: 1</p> <p>διαθέσιμα επίσης και με ύψος 3,5 cm <i>available also with height 3,5 cm</i></p>
--	---



	<p>τσέρκια εξάγωνα 2 cm ύψος <i>hexagonal rings 2 cm height</i></p> <p><b>*25.00589</b> 10 cm   2 cm 3099.60 pack: 1</p> <p><b>*25.00591</b> 24 cm   2 cm 3099.62 pack: 1</p>
--	---

	<p>τσέρκια «καρδιά», 2 cm ύψος <i>«heart» rings 2 cm height</i></p> <p><b>*25.00769</b> 8 cm   2 cm 3099.50 pack: 1</p> <p><b>*25.00770</b> 12 cm   2 cm 3099.51 pack: 1</p> <p><b>*25.00771</b> 18 cm   2 cm 3099.52 pack: 1</p> <p><b>*25.00772</b> 22 cm   2 cm 3099.53 pack: 1</p>
--	--

τσέρκια τάρτας στρογγυλά | *round tart rings*

de Buyer   
 στρογγυλά τσέρκια τάρτας  
 με τυλιγμένες άκρες,  
 ύψος 2 cm  
*tart ring, rolled edge,  
 height 2 cm*



<b>25.00350</b>	6 cm   2 cm
3091.06N	pack: 1
<b>25.00758</b>	8 cm   2 cm
3091.08N	pack: 1
<b>25.00379</b>	10 cm   2 cm
3091.10N	pack: 1
<b>25.00759</b>	12 cm   2 cm
3091.12N	pack: 1
<b>25.00760</b>	14 cm   2 cm
3091.14N	pack: 1
<b>25.00313</b>	16 cm   2 cm
3091.16N	pack: 1
<b>25.00761</b>	18 cm   2 cm
3091.18N	pack: 1
<b>25.00762</b>	20 cm   2 cm
3091.20N	pack: 1
<b>25.00314</b>	22 cm   2 cm
3091.22N	pack: 1
<b>25.00763</b>	24 cm   2 cm
3091.24N	pack: 1
<b>25.00309</b>	26 cm   2 cm
3091.26N	pack: 1
<b>25.00764</b>	28 cm   2 cm
3091.28N	pack: 1
<b>25.00765</b>	30 cm   2 cm
3091.30N	pack: 1
<b>25.00315</b>	32 cm   2 cm
3091.32N	pack: 1

στρογγυλά τσέρκια τάρτας  
 με τυλιγμένες άκρες  
*tart ring,  
 rolled edge*



διατίθενται μεγέθη  
 από 7 έως 32 cm ανά 2 cm

<b>*25.40069</b>	8 cm   2,7 cm
834920	pack: 1
<b>*25.40070</b>	10 cm   2,7 cm
834940	pack: 1
<b>*25.40071</b>	12 cm   2,7 cm
834941	pack: 1
<b>*25.40072</b>	18 cm   2,7 cm
834944	pack: 1
<b>*25.40073</b>	20 cm   2,7 cm
834950	pack: 1
<b>*25.40074</b>	24 cm   2,7 cm
834970	pack: 1

τσέρκια τάρτας | *tart ring*

τετράγωνα τσέρκια τάρτας  
 με τυλιγμένες άκρες  
*tart ring, rolled edge*



<b>*25.40061</b>	18x18 cm   2 cm
865530	pack: 1
<b>*25.40062</b>	20x20 cm   2 cm
865540	pack: 1
<b>*25.40063</b>	22x22 cm   2 cm
865550	pack: 1
<b>*25.40064</b>	24x24 cm   2 cm
865560	pack: 1
<b>*25.40065</b>	18x18 cm   2,7 cm
835530	pack: 1
<b>*25.40066</b>	20x20 cm   2,7 cm
835540	pack: 1
<b>*25.40067</b>	22x22 cm   2,7 cm
835530	pack: 1
<b>*25.40068</b>	24x24 cm   2,7 cm
835560	pack: 1

τσέρκια τετράγωνα | *square rings*

de Buyer 



τσέρκια τετράγωνα, st. steel  
*st. steel square rings*

<b>*25.00378</b>	8x8 cm   2 cm
3905.08	pack: 1
<b>*25.00496</b>	12x12 cm   2 cm
3905.12	pack: 1
<b>*25.00497</b>	16x16 cm   2 cm
3905.16	pack: 1
<b>*25.00348</b>	20x20 cm   2 cm
3905.20	pack: 1
<b>*25.00498</b>	24x24 cm   2 cm
3905.24	pack: 1
<b>*25.00349</b>	28x28 cm   2 cm
3905.28	pack: 1

τσέρκια τετράγωνα | *square rings*

de Buyer 

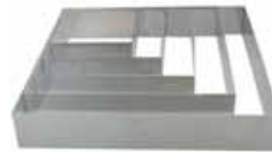

τσέρκια τετράγωνα, st. steel  
*st. steel square rings*

<b>*25.00213</b>	8x8 cm   4,5 cm (0,8 mm)
3906.08	pack: 1
<b>*25.00499</b>	12x12 cm   4,5 cm (1 mm)
3906.12	pack: 1
<b>*25.00277</b>	16x16 cm   4,5 cm (1 mm)
3906.16	pack: 1
<b>25.00087</b>	20x20 cm   4,5 cm (1 mm)
3906.20	pack: 1
<b>25.00088</b>	24x24 cm   4,5 cm (1,2 mm)
3906.24	pack: 1
<b>*25.00140</b>	28x28 cm   4,5 cm (1,2 mm)
3906.28	pack: 1





τσέρκια ορθογώνια | *rectangular rings*

de Buyer

τσέρκια ορθογώνια με οξείες γωνίες  
*st. steel rectangular rings, sharp corners*

\*25.00162 12,4x4,3 cm | 3 cm  
3943.12 pack: 1

\*25.00346 12,4x4,3 cm | 4 cm  
3943.13 pack: 1

\*25.00160 18,4x3,3 cm | 2 cm  
3941.18 pack: 1

\*25.00161 16,4x3,2 cm | 3,2 cm  
3942.16 pack: 1

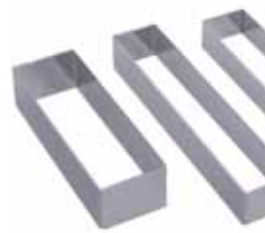

τσέρκια ρυθμιζόμενα | *adjustable rings*

de Buyer



\*25.00593 τσέρκι ρυθμιζόμενο  
στρογγυλό ύψους 3 cm  
*adjustable square ring*  
3 cm high  
18-36 cm  
pack: 1



de Buyer

τσέρκια ρυθμιζόμενα τετράγωνα  
ύψους 3 cm  
*adjustable square rings, 3 cm high*

\*25.00594 16x16 cm → 30x30 cm  
3013.16 pack: 1

\*25.00595 20x20 cm → 37x37 cm  
3013.20 pack: 1

\*25.00596 30x30 cm → 57x57 cm  
3013.30 pack: 1

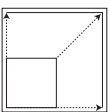

τσέρκια ρυθμιζόμενα ορθογώνια  
ύψους 3 cm  
*adjustable rectangular rings, 3 cm high*

\*25.00597 21,5x11,5 cm → 40x21 cm  
3013.21 pack: 1

\*25.00598 43x29 cm → 56x84 cm  
3013.43 pack: 1

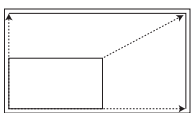

GHIDINI  
ITALY

10.40332 τσέρκι ανοξείδωτο  
ρυθμιζόμενο  
τετράγωνο ύψους 6 cm  
*adjustable square ring,*  
6 cm high  
24x20 έως 46x38 cm  
pack: 1



GHIDINI  
ITALY

10.40331 τσέρκι ανοξείδωτο  
στρογγυλό ρυθμιζόμενο,  
ύψους 8,5 cm  
*adjustable round ring*  
8,5 cm high  
16 έως 30 cm  
pack: 1

τσέρκια πλαίσιο | *pastry frames*

de Buyer

τσέρκι πλαίσιο, st. steel  
*st. steel pastry frame*

\*25.00414 57x37 cm | 3,5 cm  
3015.35 pack: 1

\*25.00510 57x37 cm | 4,5 cm  
3015.45 pack: 1







### τσέρκια «καρδιά» | *heart-shaped ring*

de Buyer

τσέρκια «καρδιά», st. steel  
st. steel heart-shaped ring

\*25.00152 6 cm | 4 cm (0,8 mm)  
3077.06 pack: 1

\*25.00347 14 cm | 4 cm (1 mm)  
3077.14 pack: 1

\*25.00427 16 cm | 4 cm (1 mm)  
3077.16 pack: 1

\*25.00492 18 cm | 4 cm (1 mm)  
3077.18 pack: 1

25.00089 20 cm | 4 cm (1 mm)  
3077.20 pack: 1

\*25.00493 22 cm | 4 cm (1 mm)  
3077.22 pack: 1

25.00090 24 cm | 4 cm (1 mm)  
3077.24 pack: 1



### τσέρκι στρογγυλό «Pain Surprise» round ring

de Buyer



\*25.00191 τσέρκι στρογγυλό, st. steel  
3912.20 st. steel round ring  
20 cm | 12 cm (1 mm)  
pack: 1

### τσέρκι στρογγυλό | round ring

HENDI



τσέρκια στρογγυλά, st. steel  
st. steel round rings

30.41217 6 cm | 4,5 cm  
pack: 1

30.40538 7 cm | 4,5 cm  
pack: 1

30.40539 9 cm | 5 cm  
pack: 1

### τσέρκια οβάλ | oblong rings

de Buyer



τσέρκια οβάλ, inox  
st. steel oval rings

\*25.00327 τσέρκι οβάλ, inox  
3099.40 st. steel oblong ring  
14,5x3,5 cm | 2 cm  
pack: 1

\*25.00624 πιεστής για οβάλ τσέρκι  
3006.04 pusher for oblong ring  
14x3,2 cm | 6,1 cm  
pack: 1

426

### τσέρκια «δάκρυ» | *teardrop rings*

de Buyer



τσέρκια «δάκρυ» st. steel  
st. steel teardrop rings

\*25.00334 8x5 cm | 4 cm (0,8 mm)  
3027.08 pack: 1

### τσέρκια οβάλ «Calisson» | oval rings

de Buyer



τσέρκια οβάλ, inox  
st. steel oval rings

\*25.00564 11x5 cm | 4 cm  
3076.11 pack: 1

### κόπτες | cutters

HENDI



30.41324 κόπτες στρογγυλοί,  
ίσοι, st. steel (σετ 14 τμχ.)  
set of 14 plain edge cutters  
1,9–11,2 cm  
pack: 1

30.41325 κόπτες στρογγυλοί  
κυματιστοί, st. steel  
(σετ 14 τμχ.)  
set of 14 serrated edge  
cutters  
1,8–10,8 cm  
pack: 1

### τσέρκια | rings

HENDI



τσέρκια στρογγυλά  
και πιεστές/καπάκια, st. steel  
st. steel round rings and pushers/lids

30.41209 8 cm | 4,5 cm  
pack: 1

30.41211 καπάκι | pusher, 8 cm  
pack: 1

30.41210 10 cm | 4,5 cm  
pack: 1

30.41212 καπάκι | pusher, 10 cm  
pack: 1

HENDI



τσέρκια τετράγωνα  
και πιεστές/καπάκια, st. steel  
st. steel square rings and pushers/lids

30.41213 6,5x6,5 cm | 4,5 cm  
pack: 1

30.41215 καπάκι | pusher, 6,5 cm  
pack: 1

30.41214 8x8 cm | 4,5 cm  
pack: 1

30.41216 καπάκι | pusher, 8 cm  
pack: 1



φόρμες st. steel με αποσπώμενα πλαϊνά  
*st. steel long mould for yule log with removable ends*

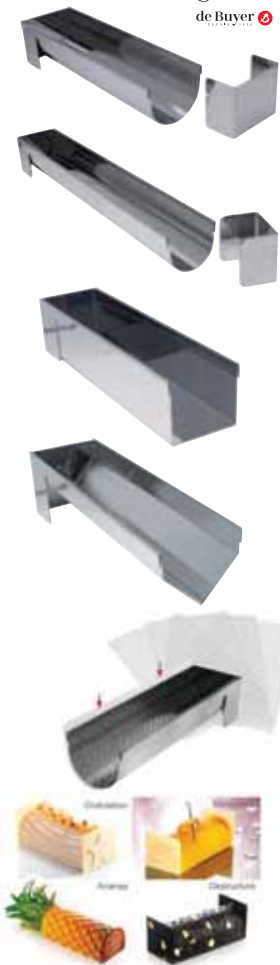

**\*25.00269** φόρμα στρογγυλή  
*round mould*  
 30 cm | 6,5 cm  
 pack: 1

**\*25.00270** φόρμα στρογγυλή  
*round mould*  
 30 cm | 4 cm  
 pack: 1

**\*25.00271** φόρμα τετράγωνη  
*square mould*  
 30 cm | 7 cm  
 pack: 1

**\*25.00272** φόρμα τρίγωνη  
*triangular mould*  
 30 cm | 6,5 cm  
 pack: 1

**\*25.00588** σετ 4 επιφάνειες  
 ανάγλυφων ντεκόρ  
*set 4 supple plastic sheets  
 for relief decoratin*  
 30x18,5 cm  
 pack: 1



φόρμες ημισφαιρικές (1,2 - 1,5 mm) | *hemispherical moulds*



φόρμες ημισφαιρικές, st. steel  
*st. steel hemispherical moulds*

**25.00190** 10 cm | 4,8 cm (25 cl)  
 3133.10 pack: 1

**\*25.00332** 12 cm | 5,9 cm (45 cl)  
 3133.12 pack: 1

**\*25.00488** 14 cm | 6,7 cm (67 cl)  
 3133.14 pack: 1

**\*25.00489** 16 cm | 8 cm (1 lt)  
 3133.16 pack: 1

**25.00096** 18 cm | 8,7 cm (1,46 lt)  
 3133.18 pack: 1

**\*25.00204** 20 cm | 10 cm (2,06 lt)  
 3133.20 pack: 1

διατίθονται επίσης / available also  
 10, 12, 16 & 20 cm

φόρμες κρεμ-καραμελέ | *crème-caramel mould*



φόρμες κρεμ-καραμελέ (0,8 mm)  
*crème-caramel mould, st. steel*

**\*25.00522** 4,5 cm | 4,2 cm (5 cl)  
 3095.45 pack: 1

**25.00097** 5,5 cm | 5,3 cm (14 cl)  
 3095.55 pack: 1

**\*25.00399** 6,5 cm | 6 cm (18 cl)  
 3095.65 pack: 1

**\*25.00403** 8 cm | 8 cm (32 cl)  
 3095.80 pack: 1

φόρμες Charlot | *Charlotte moulds*



φόρμες Charlot, st. steel  
*st. steel Charlotte moulds*

**\*25.00500** 6,7 cm | 4,5 cm  
 3125.07 pack: 1

**\*25.00502** 17,7 cm | 10 cm  
 3125.18 pack: 1

φόρμες «Baba» | *«Baba» moulds*



**30.41836** φόρμα «Baba» αλουμιν.  
 με χείλος  
*aluminium «Baba» mould  
 with roller rim*  
 7 cm | 6,8 cm  
 pack: 1



**30.41837** φόρμα «Baba» αλουμιν.  
*aluminium «Baba» mould*  
 7 cm | 6,8 cm  
 pack: 1

φόρμες τάρτας αντικολλητικές | *non-stick tart moulds*

 	αντικολλητικές φόρμες στρογγυλές <i>round fluted tart mould with straight edge</i>
	25.00519 20 cm   2 cm 4705.20 pack: 1
	25.00285 24 cm   2,8 cm 4705.24 pack: 1
	25.00294 28 cm   3 cm 4705.28 pack: 1
25.00380 32 cm   3 cm 4705.32 pack: 1	

 	αντικολλητικές φόρμες τάρτας βαθιές <i>medium deep round fluted tart mould</i>
	*25.40082 18,5/20 cm   3,5 cm 226520 pack: 1
	*25.40083 22,5/24 cm   3,5 cm 226530 pack: 1
	*25.40084 26,5/28 cm   3,5 cm 226540 pack: 1
	*25.40085 30,5/32 cm   3,5 cm 226550 pack: 1
μεγέθη από 20 έως 32 cm ανά 2 cm	

 	αντικολλητικές φόρμες στρογγυλές με λοξές πλευρές <i>round fluted tart mould with oblique edge</i>
	*25.00291 10 cm   2 cm 4703.10 pack: 1
	*25.00520 12 cm   3 cm 4703.12 pack: 1

 	*25.00521 αντικολλητική φόρμα με αυλάκι <i>round fluted fruit tart mould</i> 28 cm   3 cm pack: 1
---	--

φόρμες αντικολλητικές | *non-stick cake mould*

 	35.02124 φόρμα «Quiche Tins» αντικολλητική, διάτρητη με αποσπώμενη βάση <i>non-stick fluted round flan «Quiche Tins» with loose base</i> 30 cm   3 cm pack: 1/6
---	--







φόρμες αντικολλητικές διάτρητες  
*non-stick perforated tart moulds*

 	αντικολλητικές φόρμες τάρτας διάτρητες στρογγυλές <i>perforated round fluted tart mould</i>
	*25.40090 20 cm   2,8 cm 226321 pack: 1
	*25.40091 24 cm   2,8 cm 226331 pack: 1
	*25.40092 28 cm   2,8 cm 226341 pack: 1
	*25.40093 32 cm   2,8 cm 226351 pack: 1

 	φόρμες τάρτας διάτρητες στρογγυλές <i>perforated round fluted tart mould</i>
	*25.40098 20 cm   2,8 cm 126321 pack: 1
	*25.40099 24 cm   2,8 cm 126331 pack: 1
	*25.40100 28 cm   2,8 cm 126341 pack: 1
	*25.40101 32 cm   2,8 cm 126351 pack: 1
	μεγέθη από 20 έως 32 cm ανά 2 cm

φόρμες διάτρητες με αποσπώμενη βάση  
*perforated loose base moulds*

 	φόρμες αντικολλητικές στρογγυλές διάτρητες με αποσπώμενη βάση, <i>perforated non-stick fluted tart mould</i>
	*25.40094 20 cm   2,8 cm 226421 pack: 1
	*25.40095 24 cm   2,8 cm 226431 pack: 1
	*25.40096 28 cm   2,8 cm 226441 pack: 1
	*25.40097 32 cm   2,8 cm 226451 pack: 1
	μεγέθη από 20 έως 32 cm ανά 2 cm

 	φόρμες τάρτας στρογγυλές διάτρητες με αποσπώμενη βάση, <i>perforated round fluted tart mould</i>
	*25.40102 20 cm   2,8 cm 126421 pack: 1
	*25.40103 24 cm   2,8 cm 126431 pack: 1
	*25.40104 28 cm   2,8 cm 126441 pack: 1
	*25.40105 32 cm   2,8 cm 126451 pack: 1
	μεγέθη από 20 έως 32 cm ανά 2 cm





φόρμες με αποσπώμενη βάση | *loose base moulds*

 	<p>φόρμες τάρτας στρογγυλές, ίσια πλευρά <i>round fluted tart mould with straight edge</i></p>
	<p>*25.00273 19,8 cm   2 cm 4706.20 pack: 1</p>
	<p>*25.00274 23 cm   2,8 cm 4706.24 pack: 1</p>
	<p>*25.00275 28 cm   3 cm 4706.28 pack: 1</p>
	<p>*25.00276 32 cm   3 cm 4706.32 pack: 1</p>

	<p>φόρμες στρογγυλές αντικολλητικές <i>non-stick round fluted tart moulds</i></p>
	<p>*25.40086 18,5/20 cm   3,5 cm 226620 pack: 1</p>
	<p>*25.40087 22,5/24 cm   3,5 cm 226630 pack: 1</p>
	<p>*25.40088 26,5/28 cm   3,5 cm 226640 pack: 1</p>
	<p>*25.40089 30,5/32 cm   3,5 cm 226650 pack: 1</p>
<p>μεγέθη από 20 έως 32 cm ανά 2 cm</p>	

	<p>φόρμες στρογγυλές <i>round fluted tart mould</i></p>
	<p>*25.40075 18,5/20 cm   2,8 cm 126420 pack: 1</p>
	<p>*25.40076 20/22 cm   2,8 cm 126422 pack: 1</p>
	<p>*25.40077 23/24 cm   2,8 cm 126430 pack: 1</p>
	<p>*25.40078 24/26 cm   2,8 cm 126432 pack: 1</p>
	<p>*25.40079 27/28 cm   2,8 cm 126440 pack: 1</p>
	<p>*25.40080 28/30 cm   2,8 cm 126442 pack: 1</p>
<p>*25.40081 31/32 cm   2,8 cm 126450 pack: 1</p>	

φόρμες με αποσπώμενη βάση | *loose base moulds*

	<p>αντικολλητικές φόρμες στρογγυλές με αποσπώμενη βάση <i>non-stick round fluted cake mould with loose base</i></p>
	<p>*25.40108 8/10 cm   3 cm 224810 pack: 1</p>
	<p>*25.40109 13/15 cm   4 cm 224820 pack: 1</p>
	<p>φόρμες στρογγυλές με αποσπώμενη βάση <i>round fluted cake mould with loose base</i></p>
	<p>*25.40112 8/10 cm   3 cm 124810 pack: 1</p>
	<p>*25.40113 13/15 cm   4 cm 124820 pack: 1</p>

βάρος ζύμης | *pie weght chain*

	<p>*25.40043 αλυσίδα βάρους ζύμης <i>pie weght chain</i> pack: 1</p>
--	--



## φόρμες σαβαρέν | *savarin or ring mould*



αντικολλπ. βαθιές φόρμες σαβαρέν  
*non-stick deep savarin or ring mould*

\*25.40126 24 cm | 5,8 cm

254050 pack: 1

\*25.40127 26 cm | 6,2 cm

254060 pack: 1



## φόρμες αντικολλητικές | *non-stick cake mould*



de Buyer

φόρμες στρογγυλές από κάλυβα  
με αποσπώμενη βάση  
*dismontable round pastry mould*

25.00391 20 cm | 6,7 cm

4844.20 pack: 1

25.00386 26 cm | 6,7 cm

4844.26 pack: 1

## φόρμες με αποσπώμενη βάση | *loose base moulds*



de Buyer

25.00279 ορθογώνια φόρμα  
αντικολλητική  
με αποσπώμενη βάση  
*rectangular non-stick fluted  
tart mould with loose base*  
35,6x10,2 cm | 2,7 cm  
pack: 1

4708.36



\*25.40106 φόρμα τάρτας  
με αποσπώμενη βάση,  
*oblong fluted tart mould  
with loose base*  
35x11 cm | 2,5 cm  
pack: 1

125410

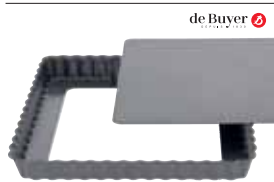

de Buyer

25.00280 τετράγωνη φόρμα τάρτας  
με αποσπώμενη βάση  
*square fluted tart mould  
with loose base*  
23x23 cm | 2,7 cm  
pack: 1

4709.23

## φόρμες αντικολλητικές | *non-stick cake mould*

KitchenCraft



φόρμες στρογγυλές  
με αποσπώμενη βάση  
*dismontable round pastry mould*

35.00065 23 cm

pack: 1

35.00066 25 cm

pack: 1

35.00067 30 cm

pack: 1

## φόρμες αντικολλητικές | *non-stick cake mould*

GHIDINI



φόρμες στρογγυλές  
με 2 αποσπώμενες βάσεις  
*round pastry mould with 2 bases*

10.50021 26 cm

pack: 1

10.50020 28 cm

pack: 1

## φόρμες διάτρητες με αποσπώμενη βάση *perforated moulds with loose base*



\*25.40107 αντικολλητική φόρμα  
ορθογώνια διάτρητη  
με αποσπώμενη βάση,  
*perforated non-stick oblong  
fluted tart mould, loose base*  
35x11 cm | 2,5 cm  
pack: 1

225412



\*25.40140 φόρμα ορθογώνια  
διάτρητη  
με αποσπώμενη βάση,  
*perforated oblong fluted  
tart mould with loose base*  
35x11 cm | 2,5 cm  
pack: 1

125412

## φόρμες κέικ αντικολλητικές | *non-stick cake mould*

KitchenCraft



35.00401 φόρμα αντικολλητική  
*non-stick round  
fluted cake tin*  
27 cm | 8 cm  
pack: 1



αντικολλητικές φόρμες κέικ  
*non-stick gugelbunf mould*

25.40128 21 cm | 8 cm

228020 pack: 1





φόρμες ψωμιού | *bread moulds*

	<p>αντικολλητική φόρμα για ψωμί τοστ <i>non-stick finger sandwiches</i></p> <p>*25.40129 20x20 cm   19 cm 219050 pack: 1</p>
	<p>αντικολλητική φόρμα με συρόμενο καπάκι <i>non-stick pullman loaf pan with sliding lid</i></p> <p>*25.40130 40x10,5 cm   9 cm 219010 pack: 1</p> <p>*25.40131 25x9,3 cm   7,6 cm 219310 pack: 1</p>
	<p>αντικολλητική φόρμα ψωμιού με αποσπώμενη βάση <i>non-stick long pan loaf pan with binges - loose bottom</i></p> <p>*25.40132 30x4 cm   6 cm 219410 pack: 1</p> <p>*25.40133 50x4 cm   6 cm 219440 pack: 1</p>
	<p>αντικολλητική φόρμα ψωμιού με αποσπώμενη βάση <i>non-stick long pan loaf pan with binges - loose bottom</i></p> <p>*25.40134 30x8 cm   8 cm 219710 pack: 1</p> <p>*25.40135 35x8 cm   8 cm 219720 pack: 1</p> <p>*25.40136 40x8 cm   8 cm 219730 pack: 1</p> <p>*25.40137 50x8 cm   8 cm 219740 pack: 1</p>



φόρμες αντικολλητικές | *non-stick cake mould*

	<p>de Buyer</p> <p>φόρμες αντικολλητικές ορθογώνιες <i>non-stick rectangular cake mould</i></p> <p>25.00517 15x7,5 cm   4,8 cm 4715.15 pack: 1</p> <p>25.00518 24x13 cm   6,1 cm 4715.24 pack: 1</p> <p>25.00306 26x10 cm   6,3 cm 4715.26 pack: 1</p>
--	--

φόρμες αλουμινίου | *aluminium moulds*

	<p>HENDI</p> <p>φόρμες αλουμινίου ορθογώνιες <i>aluminium rectangular cake moulds</i></p> <p>30.41833 18x8 cm   6 cm pack: 1</p> <p>30.41834 26x10 cm   7,5 cm pack: 1</p> <p>30.41835 30x11 cm   7,5 cm pack: 1</p>
--	--

δίσκοι μπαγκετών | *french bread trays*

	<p>HENDI</p> <p>30.41345 δίσκος αλουμινίου διάτρητος για 5 μπαγκέτες <i>aluminium perforated tray for 5 french bread</i>, 60x40 cm pack: 1</p>
	<p>HENDI</p> <p>30.41906 δίσκος αλουμινίου διάτρητος για 5 μπαγκέτες αντικολλητικός <i>aluminium perforated tray for 5 french bread, non-stick</i>, 60x40 cm pack: 1</p>

φόρμες αντικολλητικές | *non-stick cake mould*

	<p>KitchenCraft</p> <p>φόρμες τετράγωνα αντικολλητικές με αποσπώμενη βάση <i>square non-stick cake moulds, with loose base</i></p> <p>35.00402 25x25 cm   7,5 cm pack: 1</p>
--	--

## Δίνουμε σχήμα στα συναισθήματά σας

Για πάνω από 20 χρόνια η Silikomart σχεδιάζει φόρμες ζαχαροπλαστικής και μεταφέρει τη δημιουργικότητα των μεγαλύτερων σεφ ζαχαροπλαστικής της εποχής μας σε εξαιρετικά και επαναστασιακά έργα τέχνης.

Προσφέρει μεγάλα γκάμα εκλεπτυσμένων και καινοτόμων προϊόντων, με λειτουργικότητα και πρακτικότητα που ικανοποιούν τις ανάγκες όσων αγαπούν την ζαχαροπλαστική αλλά και το μαγείρεμα.

Η σιλικόνη είναι ανθεκτική στη θερμότητα, εύκαμπτη και αντικολλητική και μπορεί να χρησιμοποιηθεί σε θερμοκρασίες από  $-60^{\circ}\text{C}$  έως  $+230^{\circ}\text{C}$ . Η ασφάλεια, η ποιότητα και η απόδοση, σε συνδυασμό με τον μοναδικό σχεδιασμό των προϊόντων, καθιστούν τη Silikomart τον κορυφαίο ειδικό στη μαγειρική χρήση της σιλικόνης.



## We shape your emotions

For over 20 years Silikomart designs pastry-making moulds and transforms the creativity of some of the greatest pastry chefs of our time into extraordinary and revolutionary works of art.

Silikomart offers a wide range of refined and innovative products, with a functionality, practicality and beauty which meet the needs of all those who love pastry and cooking. The use of silicone in the kitchen provides excellent results and significant advantages. Silicone is heat resistant, flexible and non stick and can be used with temperatures ranging from  $-60^{\circ}\text{C}$  to  $+230^{\circ}\text{C}$ . Safety, quality and performance, combined with the unique design of products, makes Silikomart the leading specialist of culinary silicone use. Silikomart is providing inspiration and a help to gastronomy lovers and those who wish to approach this new world.

## φόρμες σιλικόνης



Canneles, 80 ml  
(5,6 cm | 5 cm)  
60x40 cm  
pack: 1

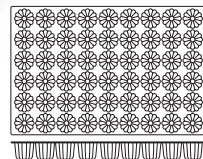

14.10014 SQ064  
Half sphere, 112 ml  
(7 cm | 4,1 cm)  
60x40 cm  
pack: 1

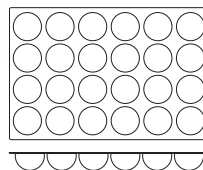

14.10001 SQ003  
Half sphere», 90 ml  
(7 cm | 3,5 cm)  
60x40 cm  
pack: 1

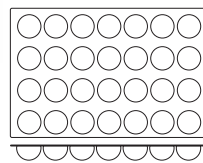

14.10017 SQ075  
Half sphere», 20 ml  
(4,2 cm | 2,2 cm)  
60x40 cm  
pack: 1

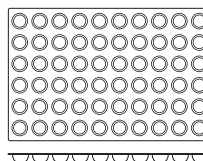

14.10002 SQ004  
Florentins, 25 ml  
(6 cm | 1,1 cm)  
60x40 cm  
pack: 1

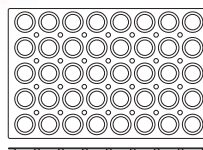



14.10003 SQ005  
Madeleine, 32 ml  
(7,7x4,4 cm | 1,8 cm)  
60x40 cm  
pack: 1

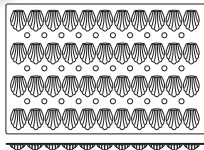

14.10009 SQ033  
Mini savarin, 12 ml  
(4,1 cm | 1,2 cm)  
60x40 cm  
pack: 1

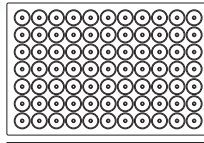

14.10013 SQ060  
Cylinders, 133 ml  
(7 cm | 3,5 cm)  
60x40 cm  
pack: 1

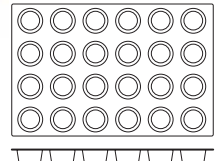

14.10008 SQ030  
Madeleine, 11 ml  
(4,6x3,3 cm | 1,4 cm)  
60x40 cm  
pack: 1

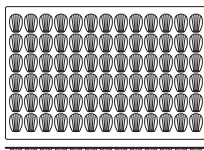

14.10010 SQ044  
Florentins, 33,5 ml  
(6 cm | 1,2 cm)  
60x40 cm  
pack: 1

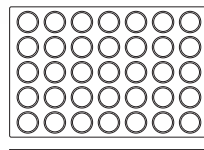

14.10012 SQ059  
Donuts, 133 ml  
(8,5 cm | 2,9 cm)  
60x40 cm  
pack: 1

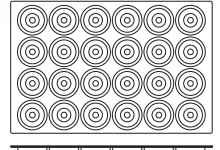

14.10004 SQ009  
Muffin, 122 ml  
(6,9 cm | 3,9 cm)  
60x40 cm  
pack: 1

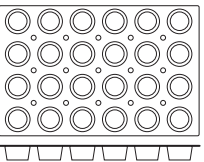

14.10005 SQ012  
Discs, 200 ml  
(16 cm | 1 cm)  
60x40 cm  
pack: 1

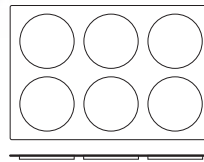

14.10016 SQ072  
Infinity, 480 ml  
(33,6x4,7 cm | 4 cm)  
60x40 cm  
pack: 1

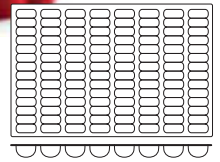

14.10011 SQ056  
Small oval, 20 ml  
(5,1x3,1 cm | 2 cm)  
60x40 cm  
pack: 1

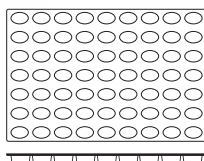

14.10006 SQ013  
Discs, 112 ml  
(12 cm | 1 cm)  
60x40 cm  
pack: 1

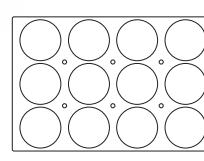

14.10007 SQ014  
Tronco, 2.137 ml  
(49,5x8 cm | 6,3 cm)  
60x40 cm  
pack: 1

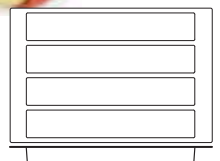

14.10015 SQ071  
Quenelle, 24 ml  
(6,3x3,1 cm | 2,8 cm)  
60x40 cm  
pack: 1

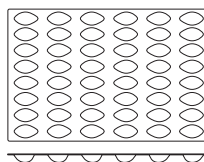





**14.10080** 20.341.87.0065  
«Cloud», 1,600 ml  
20x20 cm | 5,5 cm  
pack: 1



**14.10085** 25.401.99.0065  
«Klassik» (set 2 pcs.)  
2x290 ml  
15,7 cm | 15 cm  
pack: 1



**14.10090** 28.205.87.0065  
«Vague», 1,100 ml  
20 cm | 4,5 cm  
pack: 1

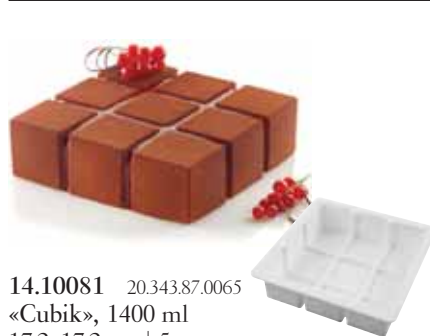

**14.10081** 20.343.87.0065  
«Cubik», 1,400 ml  
17,2x17,2 cm | 5 cm  
pack: 1



**14.10086** 25.931.87.0065  
«Lady Queen» (set 2 pcs.)  
1000 ml  
18/6 cm | 5 cm  
pack: 1

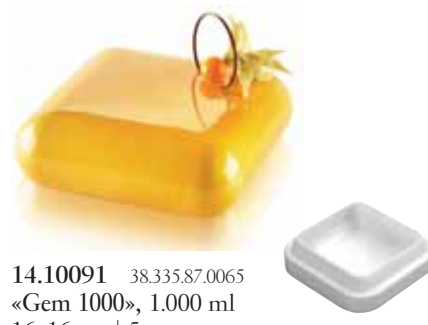

**14.10091** 38.335.87.0065  
«Gem 1000», 1,000 ml  
16x16 cm | 5 cm  
pack: 1



**14.10083** 20.376.87.0065  
«Eclipse», 600 ml  
14 cm | 4,3 cm  
pack: 1



**14.10087** 25.955.99.0065  
«Magia del tempo» (set 3 pcs.)  
1000 ml  
18,5 cm | 6 cm  
pack: 1



**14.10084** 20.394.87.0065  
«Universo», 600 ml  
14 cm | 4,5 cm  
pack: 1



**14.10082** 20.349.87.0065  
«Universo», 1,200 ml  
18 cm | 5 cm  
pack: 1



**14.10088** 27.227.87.0065  
«Paradise», 1,500 ml  
22/7 cm | 6 cm  
pack: 1



**14.10089** 28.201.87.0065  
«Eclipse» (set 2 pcs.)  
1000 ml  
18,5 cm | 4,5 cm  
pack: 1



**14.10193** 33.301.36.0065  
«Bosco»  
9x2,8 ml + 12x1,2 ml  
6x3,7 cm | 1,5 cm + 7,1x6,9 cm  
pack: 1



**14.10197** 33.305.36.0065  
«Quadrato 3»  
8x2 ml + 8x12 ml + 8x30 ml  
2x2 cm + 5,6x5,6 + 9,8x9,8 cm | 0,5 cm  
pack: 1



**14.10201** 36.330.36.0065  
«Pomodoro»  
12x24 ml  
4,3 cm | 2,8 cm  
pack: 1



**14.10194** 33.302.36.0065  
«Foresta»  
12x1,1 ml + 12x1,7  
6,6x3 cm | 1,5 cm + 6,2x4,3 cm  
pack: 1



**14.10198** 33.306.36.0065  
«Quadrato 4»  
32x12,5 ml  
4,8x4,8 cm - 9,8x9,8 cm  
pack: 1



**14.10202** 36.328.36.0065  
«Carota»  
12x20 ml  
7,8x2,3 cm | 2,3 cm  
pack: 1



**14.10195** 33.303.36.0065  
«Cerchio 3»  
12x20 ml  
6,8x2,6 cm | 2,1 cm  
pack: 1



**14.10199** 33.308.36.0065  
«Triangolo 2.0»  
12x25 ml + 12x5 ml  
11x9,7 cm - 4,2x3,7 cm  
pack: 1



**14.10203** 36.327.36.0065  
«Pannocchia»  
12x20 ml  
6,8x2,6 cm | 2,1 cm  
pack: 1



**14.10196** 33.304.36.0065  
«Cerchio 4»  
9x40 ml  
10 cm | 0,5 cm  
pack: 1



**14.10200** 33.307.36.0065  
«Triangolo 3.0»  
36x10,5 ml  
10,3x6,5 cm | 0,5 cm  
pack: 1



**14.10204** 36.329.36.0065  
«Peperoncino»  
12x13 ml  
9,1x3,1 cm | 1,6 cm  
pack: 1



**14.10330** 33.317.36.0065  
«Mela&Pera»  
28 τμχ./pcs  
8x5,6 - 6x5,1 | 0,15 cm  
pack: 1



**14.10329** 33.316.36.0065  
«Botanica»  
34 τμχ./pcs  
8,4 - 4,6 cm | 0,15 cm  
pack: 1



**14.10328** 33.318.36.0065  
«Verza»  
12x12 ml  
7 cm | 0,5 cm  
pack: 1

## modern single portions



**14.10018** 25.268.99.0065  
«The Ring» (set 3 pcs.)  
6x6,5 ml  
8,5/5 cm | 1,8 cm  
pack: 1



**14.10028** 36.258.87.0065  
«Truffles»  
15x40 ml  
4,2 cm | 3,6 cm  
pack: 1



**14.10026** 36.254.87.0065  
«Bloom 120»  
6x120 ml  
6,8 cm | 5,2 cm  
pack: 1



**14.10033** 36.296.87.0065  
«Universo 90»  
6 x 90 ml  
6,7 cm | 2,7 cm  
pack: 1

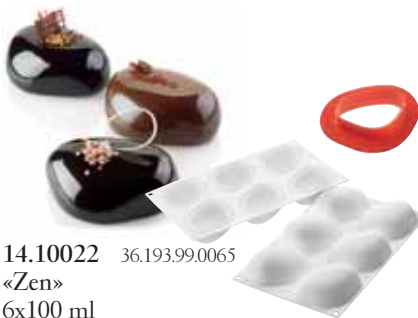

**14.10022** 36.193.99.0065  
«Zen»  
6x100 ml  
8,7x6,3 cm | 3,6 cm  
pack: 1



**14.10027** 36.256.87.0065  
«Goutte 55»  
8x55 ml  
5,4 cm | 4 cm  
pack: 1



**14.10020** 36.187.87.0065  
«Quenelle»  
12x24 ml  
6,3x2,9 cm | 2,8 cm  
pack: 1



**14.10023** 36.236.87.0065  
«Square sphere»  
8x110 ml  
6x6 cm | 3,9 cm  
pack: 1



**14.10031** 36.278.87.0065  
«Mela, Ciliegia & Pesca»  
15x30 ml  
3,9 cm | 3 cm  
pack: 1



**14.10021** 36.192.87.0065  
«Truffles»  
8x120 ml  
6,2 cm | 5,2 cm  
pack: 1



**14.10024** 36.247.87.0065  
«Cylindre», 8x110 ml  
6x6 cm | 3,9 cm  
με 10 δισκάκια και φόρμα κοπής  
pack: 1



**14.10321** 36.380.87.0065  
«Secret», 8x110 ml  
6,2 cm | 4,9 cm  
pack: 1



**14.10029** 36.259.87.0065  
«Truffles»  
8x70 ml  
5,2 cm | 4,5 cm  
pack: 1



**14.10030** 36.274.87.0065  
«Cloud»  
6x120 ml  
7,1x7,1 cm | 3,4 cm  
pack: 1



**14.10019** 36.163.87.0065  
«Stone»  
8x85 ml  
6,5 cm | 3 cm  
pack: 1



**14.10032** 36.288.87.0065  
«Cylindre 30»  
12x30 ml  
7,8x2,2 cm | 2,2 cm  
με 12 δισκάκια και φόρμα κοπής  
pack: 1



**14.10322** 36.386.87.0065  
«Rainbow 26», 16x26 ml  
6,5x16 cm | 3,25 cm  
pack: 1



**14.10327** 25.366.87.0098  
«GEL016 Rondo», 8x75 ml  
3,2 cm | 9,7 cm  
pack: 1



**14.10034** 36.319.87.0065  
«L'Éclair 120»  
8x120 ml  
13,5x2,8 cm | 3,7 cm  
με 10 δισκάκια και φόρμα κοπής  
pack: 1



**14.10025** 36.248.87.0065  
«Fingers 75»  
12x75 ml  
13x2,7 cm | 2,7 cm  
με 10 δισκάκια και φόρμα κοπής  
pack: 1



**14.10326** 25.397.87.0060  
«GEL017 Sun», 6x35 ml  
5,4 cm | 1,9 cm  
pack: 1

*decorative elements*



**14.10068** 33.051.20.0065  
«Wood» επιφάνεια ψησίματος σιλικόνης  
*silicone baking sheet*  
25x18,5 cm  
pack: 1



**14.10324** 36.383.87.0065  
«Tutù 24», 6x24 ml  
7,5 cm | 0,8 cm  
pack: 1



**14.10037** 36.312.87.0065  
«Plissé», 6x23 ml  
7,5 cm | 0,7 cm  
pack: 1



**14.10035** 36.231.87.0065  
«Tourbillon», 2x100 ml  
14 cm | 0,9 cm  
pack: 1



**14.10325** 36.382.87.0065  
«Tutù 100», 2x100 ml  
14 cm | 0,9 cm  
pack: 1



**14.10036** 36.311.87.0065  
«Plissé», 2x100 ml  
14 cm | 1 cm  
pack: 1

*φόρμες σιλικόνης | silicone moulds*



**14.10092** SFT124  
Round (με δαχτυλίδι προστασίας), 1,7 lt  
24 cm | 4,7 cm  
pack: 1



**14.10095** Sf 1424  
Flan pan (με δαχτυλίδι προστασίας), 1,25 lt  
24 cm | 3 cm  
pack: 1



**14.10094** SFT330  
Plum cake (με δαχτυλίδι προστασίας), 1,5 lt  
26x10 cm | 7 cm  
pack: 1

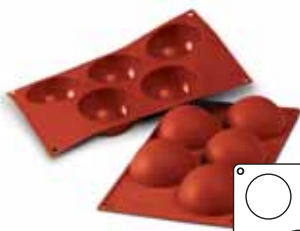

**14.10038** SF001  
5 half sphere, 120 ml  
(8 cm | 4 cm)  
17,3x29,7 cm  
pack: 1

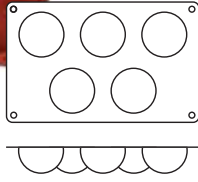

**14.10043** SF006  
24 half sphere, 10 ml  
(3 cm | 1,5 cm)  
17,3x29,7 cm  
pack: 1

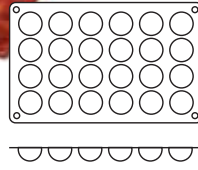

**14.10048** SF023  
6 med. muffin, 100 ml  
(6,9 cm | 3,5 cm)  
17,3x29,7 cm  
pack: 1

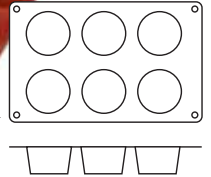

**14.10039** SF002  
6 half sphere, 80 ml  
(7 cm | 3,5 cm)  
17,3x29,7 cm  
pack: 1

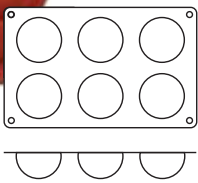

**14.10044** SF009  
24 pomponnetes, 18 ml  
(3,4 cm | 1,6 cm)  
17,3x29,7 cm  
pack: 1

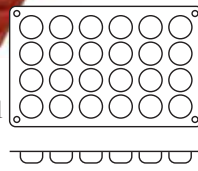

**14.10049** SF024  
5 big muffin, 135 ml  
(8,1 cm | 3,2 cm)  
17,3x29,7 cm  
pack: 1

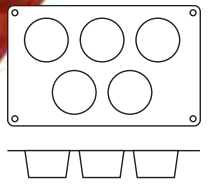

**14.10040** SF003  
6 half sphere, 60 ml  
(6 cm | 3 cm)  
17,3x29,7 cm  
pack: 1

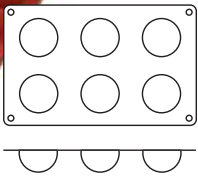

**14.10045** SF012  
6 big savarin, 62 ml  
(7,2 cm | 2,3 cm)  
17,3x29,7 cm  
pack: 1

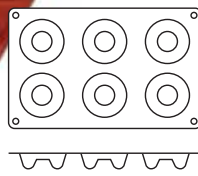

**14.10050** SF026  
12 cakes, 70 ml  
(7,9x2,9 cm | 3 cm)  
17,3x29,7 cm  
pack: 1

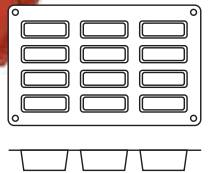

**14.10041** SF004  
8 half sphere, 30 ml  
(5 cm | 2,5 cm)  
17,3x29,7 cm  
pack: 1

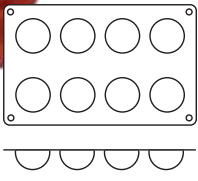

**14.10046** SF016  
6 tartelette, 70 ml  
(7 cm | 2 cm)  
17,3x29,7 cm  
pack: 1

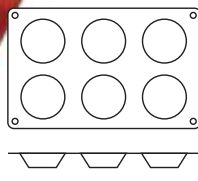

**14.10051** SF027  
15 petit fours, 30 ml  
(4 cm | 2 cm)  
17,3x29,7 cm  
pack: 1

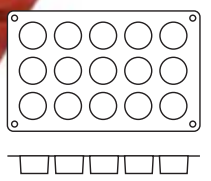

**14.10042** SF005  
15 half sphere, 20 ml  
(4 cm | 2 cm)  
17,3x29,7 cm  
pack: 1

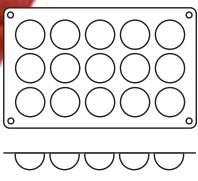

**14.10047** SF022  
11 small muffin, 50 ml  
(5,1 cm | 2,8 cm)  
17,3x29,7 cm  
pack: 1

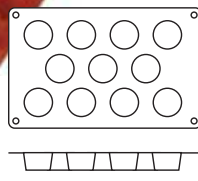

**14.10052** SF028  
8 cylinders, 90 ml  
(6 cm | 3,5 cm)  
17,3x29,7 cm  
pack: 1

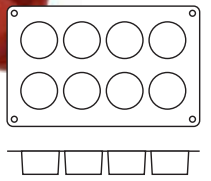



**14.10053** SF029  
8 Florentins, 35 ml  
(6 cm | 1,2 cm)  
17,3x29,7 cm  
pack: 1

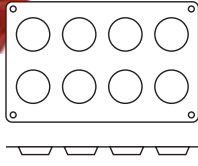

**14.10058** SF050  
8 big bordelais, 92 ml  
(5,5 cm | 5 cm)  
17,3x29,7 cm  
pack: 1

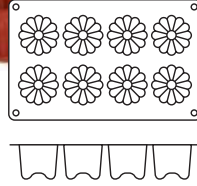

**14.10062** SF119  
8 Cylinders, 123 ml  
(6,3 cm | 4 cm)  
17,3x29,7 cm  
pack: 1

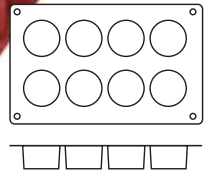

**14.10054** SF032  
9 Madeleine, 30 ml  
(6,8x4,5 cm | 1,7 cm)  
17,3x29,7 cm  
pack: 1

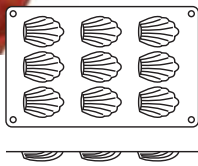

**14.10059** SF085  
8 big oval savarin, 72 ml  
(7,4x5,7 cm | 2,7 cm)  
17,3x29,7 cm  
pack: 1

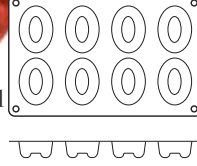

**14.10065** SF263  
40 small cube, 13 ml  
(2,4x2,4 cm | 2,4 cm)  
17,3x29,7 cm  
pack: 1

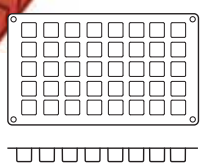

**14.10055** SF034  
6 Briochette, 110 ml  
(7,9 cm | 3,7 cm)  
17,3x29,7 cm  
pack: 1

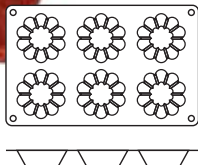

**14.10060** SF104  
8 cubes, 125 ml  
(5x5 cm | 5 cm)  
17,3x29,7 cm  
pack: 1



**14.10063** SF169  
82 choco ABC, 115 ml  
17,3x29,7 cm  
pack: 1

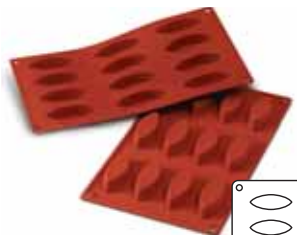
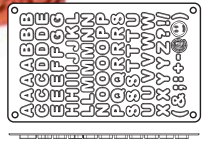

**14.10056** SF038  
12 medium boat, 20 ml  
(7,2x3 cm | 1,5 cm)  
17,3x29,7 cm  
pack: 1

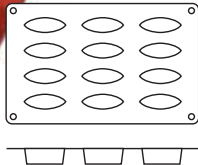

**14.10061** SF105  
15 cubes, 42 ml  
(3,5x3,5 cm | 3,5 cm)  
17,3x29,7 cm  
pack: 1

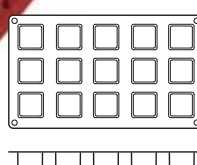

**14.10064** SF174  
60 choco 123, 124 ml  
17,3x29,7 cm  
pack: 1

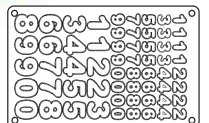

Gugelhopf (με δακτυλίδι προστασίας)

**14.10093** SFT249  
1,5 lt (20 cm | 9 cm) pack: 1  
**14.10097** SFT250  
2,2 lt (22 cm | 11 cm) pack: 1



**14.10057** SF039  
9 big boat, 40 ml  
(10x4,4 cm | 1,5 cm)  
17,3x29,7 cm  
pack: 1

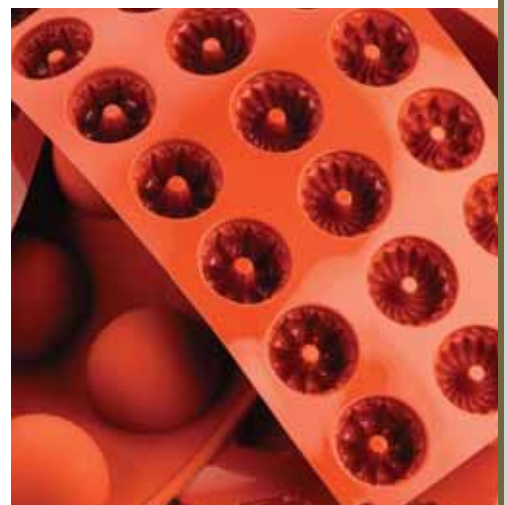
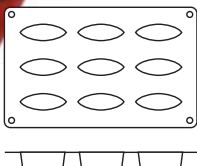



# VICTORINOX

Η ιστορία της Victorinox ξεκινά το 1884, όταν ο Karl Elsener εγκαινίασε το πρώτο του εργαστήριο κοπής. Η επαναστατική του ιδέα για κατασκευή ενός συμπαγούς μαχαιριού με πρακτική λαβή οδήγησε στην επιτυχία της Victorinox, η οποία σηματοδοτήθηκε με τον κλασικό Swiss Army σουγιά.

Οι υψηλές ποιοτικές προδιαγραφές, η λειτουργικότητα και ο εμβληματικός σχεδιασμός είναι προτεραιότητες για τη Victorinox, η οποία αφογκραζόμενη τις ανάγκες του σύγχρονου επαγγελματία, εξεδίσσει συνεχώς τα προϊόντα της. Σήμερα είναι ένα από τα πλέον αναγνωρίσιμα brands σε παγκόσμιο επίπεδο, για επαγγελματικά και οικιακά μαχαίρια.

Η συνδρογή της περιλαμβάνει μαχαίρια γενικής χρήσης, τεμαχισμού, σερφ αλλά και μαχαίρια για εξειδικευμένες κοπές, σε κάθε διάσταση. Τη συνδρογή συμπληρώνουν τα πρόσθετα αξεσουάρ απαραίτητα για μια κουζίνα.

Κάθε σειρά μαχαιριών έχει τη δική της καινοτόμο κατασκευή και λειτουργική αισθητική, με εξειδικευμένες λεπίδες που την καθιστούν εύχρηστη και απαραίτητη σε κάθε επαγγελματία. Κατασκευάζονται από υψηλής ποιότητας ανοξείδωτο ατσάλι, που σε συνδυασμό με τις εργονομικές λαβές προσφέρουν υψηλές επαγγελματικές επιδόσεις.

Η προστασία του περιβάλλοντος και η βιωσιμότητα είναι ύψιστης προτεραιότητας για τη Victorinox. Η εταιρεία υιοθετεί και εξεδίσσει διαρκώς μεθόδους παραγωγής φιλικές προς το περιβάλλον και χρησιμοποιεί ανακυκλωμένες πρώτες ύλες, σε μεγάλο βαθμό.

Οι συνδρογές Grand Maitre, Fibrox και Swiss Classic, είναι οι βασικές σειρές της Victorinox, διαθέτοντας μια πλήρη γκάμα μαχαιριών για κάθε χρήση.

Όλα τα μαχαίρια έχουν lifetime Guarantee για το υλικό και την τεχνική αριστηότητά τους. Φυσιολογικές φθορές ή εσφαλμένη χρήση δεν καλύπτονται από την εγγύηση.

The history of Victorinox begins in 1884, when Karl Elsener established his first cuttler's workshop. His pioneering idea of making a compact knife with a practical handle led to the success of Victorinox, which was marked by the classic Swiss Army knife.

High quality specifications, functionality and iconic design are priorities for Victorinox, which considering the needs of the professionals, is constantly evolving its products. In our days, it is one of the most recognizable brands worldwide, for professional and household knives.

The collection includes knives for general use, slicing, chef's, as well as knives for specialized cuts, in many dimensions. The collection is accompanied by the additional accessories, necessary for a kitchen.

Each collection of knives has its own innovative construction and aesthetic functionality, with specialized blades that makes it easy for use and essential for any professional. They knives are made of high-quality stainless steel, which combined to the ergonomic handles offer high professional performance.

Environmental protection and sustainability are top priorities for Victorinox. The company adopts and constantly develops environmentally friendly production methods and recycled raw materials, to a large extent.

The Grand Maitre, Fibrox and Swiss Classic collections are Victorinox's core collections, offering a complete range of knives for any use.

All knives have a lifetime guarantee for their material and technical excellence. Normal decay or misuse are not covered by the warranty.





«Grand Maitre»



VICTORINOX

παπαγαλάκι μαύρο | *peeling black*

96.35000 8 cm  
7.7303.08G pack: 1



κουζίνας μαύρο | *paring black*

96.35001 8 cm  
7.7203.08G pack: 1



96.35002 10 cm  
7.7203.10G pack: 1

κουζίνας οδοντωτό μαυρό | *paring wavy edge black*

96.35003 12 cm  
7.7203.12WG pack: 1



γενικής χρήσης μαύρο | *utility black*

96.35004 15 cm  
7.7203.15G pack: 1



96.35005 20 cm  
7.7203.20G pack: 1

chef's μαύρο | *chef's black*

96.35006 15 cm  
7.7403.15G pack: 1

96.35007 20 cm  
7.7403.20G pack: 1

96.35008 25 cm  
7.7403.25G pack: 1



santoku granton edge

96.35009 17 cm  
7.7323.17G pack: 1



φιλεταρίσματος μαύρο | *carving black*

96.35010 20 cm  
7.7213.20G pack: 1



πιρούνα ψητού | *carving knife*

96.35011 15 cm  
7.7233.15G pack: 1



96.35081 θήκη 8 μαχαριών | *case for 8 knives*  
7.4011.47 47x48 cm  
pack: 1

θήκη μαχαριών  
*case for knives*  
96.35083 82x48 cm  
7.4010.82 pack: 1  
96.35082 56x48 cm  
7.4010.56 pack: 1



«Fibrox»



VICTORINOX

chef's μαύρο | *chef's black*

96.35012 15 cm

5.2003.15 pack: 1

96.35015 19 cm

5.2003.19 pack: 1

96.35020 25 cm

5.2003.25 pack: 1



chef's πράσινο | *chef's green*

96.35013 15 cm

5.2004.15 pack: 1

96.35016 19 cm

5.2004.19 pack: 1

96.35021 25 cm

5.2004.25 pack: 1



chef's κόκκινο | *chef's red*

96.35014 15 cm

5.2001.15 pack: 1

96.35018 19 cm

5.2001.19 pack: 1

96.35022 25 cm

5.2001.25 pack: 1



chef's μπλε | *chef's blue*

96.35017 15 cm

5.2002.19 pack: 1

96.35023 25 cm

5.2002.25 pack: 1



chef's κίτρινο | *chef's yellow*

96.35019 15 cm

5.2008.19 pack: 1

96.35024 25 cm

5.2008.25 pack: 1



φιλεταρίσματος μαύρο | *filleting black*

96.35025 20 cm

5.3763.20 pack: 1



φιλεταρίσματος ψαριού μαύρο | *fish filleting black*

96.35026 18 cm

5.3813.18 pack: 1



slicing οδοντωτό μαύρο | *slicing wavy edge black*

96.35027 30 cm

5.4233.30 pack: 1

96.35028 36 cm

5.4233.36 pack: 1



slicing μαύρο | *slicing edge black*

96.35031 25 cm

5.4403.25 pack: 1



slicing μαύρο | *slicing edge black*

96.35029 30 cm

5.4203.30 pack: 1

96.35030 36 cm

5.4203.36 pack: 1



κρέατος μαύρο | *butcher black*

96.35035 20 cm

5.5503.20 pack: 1

96.35036 25 cm

5.5503.25 pack: 1



κρέατος μαύρο | *butcher black*

96.35032 26 cm

5.5203.26 pack: 1

96.35033 28 cm

5.5203.28 pack: 1

96.35034 31 cm

5.5203.31 pack: 1



ξεκοκαλίματος μαύρο | *boning black*

96.35037 15 cm

5.6003.15 pack: 1



ξεκοκαλίματος κόκκινο | *boning red*

96.35038 15 cm

5.6001.15 pack: 1



ξεκοκαλίματος μπλε | *boning blue*

96.35039 15 cm

5.6002.15 pack: 1



ξεκοκαλίματος κίτρινο | *boning yellow*

96.35040 15 cm

5.6008.15 pack: 1



ξεκοκαλίματος μαύρο | *boning black*,

96.35041 15 cm

5.6413.15 pack: 1



ξεκοκαλίματος μαύρο | *boning black*,

96.35042 15 cm

5.6603.15 pack: 1

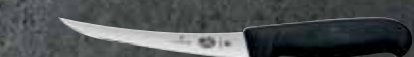

ξεκοκαλίματος κόκκινο | *boning red*

96.35043 15 cm

5.6601.15 pack: 1



ξεκοκαλίματος κίτρινο | *boning yellow*

96.35044 15 cm

5.6608.15 pack: 1



santoku granton edge

96.35045 17 cm

5.2523.17 pack: 1



ζαχαροπλαστικής μαύρο | *pastry black*

96.35046 26 cm

5.2933.26 pack: 1



ψωμιού μαύρο | *bread black*

96.35048 21 cm

5.2533.21 pack: 1

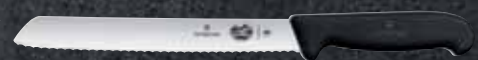

σολωμού μαύρο | *salmon black*,

96.35049 30 cm

5.4623.30 pack: 1





VICTORINOX



«Swiss Classic»

μαχαίρι κουζίνας οδοντωτό | *paring serrated knife*, 11 cm

96.35070 μαύρο | *black*  
6.7833 pack: 1



96.35071 κόκκινο | *red*,  
6.7831 pack: 1



μαχαίρι κουζίνας | *paring knife*, 8 cm

96.35050 μαύρο | *black*  
6.7603 pack: 1



96.35051 κόκκινο | *red*,  
6.7601 pack: 1



96.35052 πράσινο | *green*  
6.7606.L114 pack: 1



96.35053 ροζ | *pink*  
6.7606.L115 pack: 1



96.35054 κίτρινο | *yellow*  
6.7606.L118 pack: 1



μαχαίρι κουζίνας οδοντωτό | *paring serrated knife*, 8 cm

96.35055 μαύρο | *black*  
6.7633 pack: 1



96.35056 κόκκινο | *red*,  
6.7631 pack: 1



96.35057 πράσινο | *green*  
6.7636.L114 pack: 1



96.35058 ροζ | *pink*  
6.7636.L115 pack: 1



96.35059 κίτρινο | *yellow*  
6.7636.L118 pack: 1



μαχαίρι κουζίνας | *paring knife*, 10 cm

96.35060 μαύρο | *black*  
6.7703 pack: 1



96.35061 κόκκινο | *red*,  
6.7701 pack: 1



96.35062 πράσινο | *green*  
6.7706.L114 pack: 1



96.35063 ροζ | *pink*  
6.7706.L115 pack: 1



96.35064 κίτρινο | *yellow*  
6.7706.L118 pack: 1



μαχαίρι κουζίνας οδοντωτό | *paring serrated knife*, 10 cm

96.35065 μαύρο | *black*  
6.7733 pack: 1



96.35066 κόκκινο | *red*,  
6.7731 pack: 1



96.35067 πράσινο | *green*  
6.7736.L4 pack: 1



96.35068 ροζ | *pink*  
6.7736.L5 pack: 1



96.35069 κίτρινο | *yellow*  
6.7736.L8 pack: 1



**μασάτι** | *knife sharpeners*

μασάτι μαύρο | *knife sharpener black*

96.35072 στρογγυλό | *round*, 25 cm  
7.8303 pack: 1



μασάτι μαύρο | *knife sharpener black*

96.35073 στρογγυλό | *round*, 27 cm  
7.8333 pack: 1

96.35074 οβάλ | *oval*, 27 cm  
7.8343 pack: 1



μασάτι κόκκινο | *knife sharpener red*

96.35075 οβάλ | *oval*, 30 cm  
7.8623 pack: 1



μπαλντάς | *cleaver*

96.35047 18 cm  
5.4063.18 pack: 1



Η επιθυμία του σύγχρονου σεφ είναι να ξεχωρίζει μέσα από τη δουνδειά του. Ένα απαραίτητο εργαλείο στην πορεία του είναι ένα σετ αξιόπιστων μαχαिरιών που να εγγυάται το επιθυμητό αποτέλεσμα με ακρίβεια και ταχύτητα.

Η σειρά μαχαिरιών Anarchy επιτυχάνει δυο αποδείξεις: δίνει αυτοπεποίθηση για το τέλειο αποτέλεσμα αλλά και κυριαρχεί με την ακτινοβολία και την ξεχωριστή της παρουσία μέσα στον χώρο.

Η επιβλητική και μοναδική τους εμφάνιση οφείλεται:

- στη λάμα από 3,5mm μονοκόμματο ατσάλι με την ιδανική αναλογία σε χρώμιο και άνθρακα που εξασφαλίζει ανθεκτικότητα στην διάβρωση και πιο κοφτερή λάμα για περισσότερο χρόνο
- στη λαβή από αποκλειστικό καφέ/μαύρο υλικό Micarta που θυμίζει ξύλο αλλά είναι καταδεδειγμένο για το περιβάλλον υγιεινής της κουζίνας. Κατασκευάζεται από δινό και ειδικό πδαστικό που ενώνονται κάτω από υψηλή πίεση και θερμοκρασία. Σε σχέση με το ξύλο το Micarta είναι πολύ πιο ανθεκτικό στην υγρασία και τα μικρόβια.
- στη χαρακτηριστική σφραγίδα, σχεδιασμένη από απόφιο μπρούτζο σαν κόσμημα και σε συνδυασμό με το μόιο που είναι χαραγμένο στη ράχη της λαβής διαφοροποιεί και προσωποποιεί κάθε μαχαίρι. Κάθε μαχαίρι της σειράς φέρει το δικό του μόιο.

Η σειρά Anarchy είναι μοναδική και ξεχωριστή για την σύγχρονη κουζίνα και δεν θυμίζει τίποτα από τα συνηθισμένα. Ποιοικά μαχαίρια όπου το ατσάλι και ο μπρούτζος συμβιώνουν και δημιουργούν μια υπέροχη παύση.

Το κάθε μαχαίρι φέρει τον δικό του κωδικό παραγωγής.



Η ICEL δημιουργεί την σειρά Anarchy.

Anarchy knives were born out of a need. A need to stand out.

*it's always darkerst  
before the dawn*

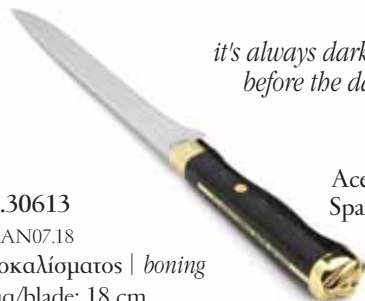

\*47.30613

22CAN07.18

Ξεκοκάλισματος | *boning*

λάμα/blade: 18 cm

pack: 1

Ace of  
Spades

*anarchy is the only slight  
glimmer of hope*

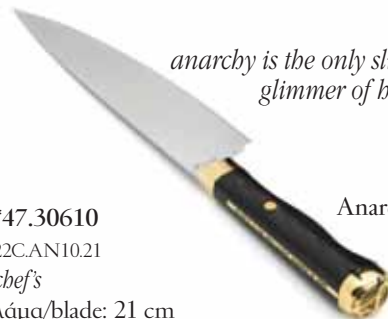

\*47.30610

22CAN10.21

chef's

λάμα/blade: 21 cm

pack: 1

Anarchy

*everybody has a plan  
until they get punched  
in the face*



\*47.30611

22CAN26.18

Japanese cleaver

λάμα/blade: 18 cm

pack: 1

Ratoon

*peace through  
superior firepower*



\*47.30615

22CAN09.23

ψωμιού | *bread*

λάμα/blade: 23 cm

pack: 1

Bullet

*death knocks once,  
dying, countless times*

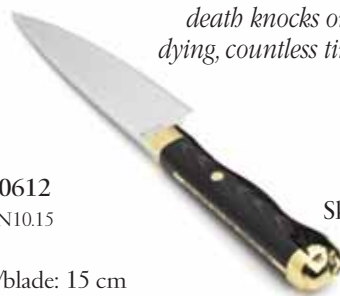

\*47.30612

22CAN10.15

chef's









λάμα/blade: 15 cm







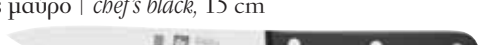

pack: 1

Skull





- 47.34152 παπαγαλάκι μαύρο | *peeling black*, 6 cm  
pack: 1 
- 47.34153 κουζίνας μαύρο | *paring black*, 10 cm  
pack: 1 
- 47.34340 κουζίνας μαύρο | *kitchen black*, 19 cm  
pack: 1 
- 47.38055 κουζίνας οδοντωτό μαύρο  
*utility wavy edge, black*, 10 cm  
pack: 1 
- 47.34151 φιλεταρίσματος μαύρο | *fillet black*, 15 cm  
pack: 1 
- 47.34150 ξεκοκαλίσματος μαύρο | *boning black*, 15 cm  
pack: 1 
- 47.34146 chef's μαύρο | *chef's black*, 15 cm  
pack: 1 
- 47.34243 chef's μαύρο | *chef's black*, 18 cm  
pack: 1 
- 47.34147 chef's μαύρο | *chef's black*, 20 cm  
pack: 1 

- 47.34148 chef's μαύρο | *chef's black*, 25 cm  
pack: 1 
- 47.34149 chef's μαύρο | *chef's black*, 30 cm  
pack: 1 
- 47.34157 slicing μαύρο | *slicing black*, 30 cm  
pack: 1 
- 47.34155 slicing οδοντωτό μαύρο | *slicing wavy edge, black*, 30 cm  
pack: 1 
- 47.34244 ψωμιού μαύρο | *bread black*, 20 cm  
pack: 1 
- 47.35500 ψντού μαύρο | *carving black*, 20 cm  
pack: 1 
- 47.34160 ψντού μαύρο | *carving black*, 25 cm  
pack: 1 
- 47.35715 ψντού οδοντωτό μαύρο  
*carving wavy edge, black*, 20 cm  
pack: 1 
- 47.34158 πιρούνα ψντού μαύρη | *carving fork*, 20 cm  
pack: 1 

γιαπωνέζικα μαχαίρια «Tokyo» *Japanese knives*

Μονοκόμιατ δάμα lifoflex λαβή αντισθητική, πλένονται στο πλυντήριο αν και προεινείται το πλύσιμο στο χέρι για σεβασμό στη δάμα.



- 47.30600 «Deba», 15 cm  
pack: 1 
- 47.30601 «Deba», 21 cm  
pack: 1 
- 47.30602 «Yanagiba», 24 cm  
pack: 1 
- 47.30603 «Usuba», 18 cm  
pack: 1 

47.39130 παπαγαλάκι μαύρο | *peeling black*,  
6 cm  
pack: 1



47.38822 παπαγαλάκι πράσινο | *peeling green*,  
6 cm  
pack: 1



47.38812 κουζίνας μαύρο | *paring black*,  
10 cm  
pack: 1



47.38814 κουζίνας κόκκινο | *paring red*,  
10 cm  
pack: 1



47.38813 κουζίνας κίτρινο | *paring yellow*,  
10 cm  
pack: 1



47.38815 κουζίνας πράσινο | *paring green*,  
10 cm  
pack: 1



47.38816 κουζίνας μπλε | *paring blue*,  
10 cm  
pack: 1



47.38817 κουζίνας οδοντωτό μαύρο | *paring wavy edge black*  
10 cm  
pack: 1



47.38819 κουζίνας οδοντωτό κόκκινο | *paring wavy edge red*  
10 cm  
pack: 1



47.38818 κουζίνας οδοντωτό κίτρινο | *paring wavy edge yellow*  
10 cm  
pack: 1



47.38820 κουζίνας οδοντωτό πράσινο | *paring wavy edge green*  
10 cm  
pack: 1



47.39349 γενικής χρήσης κίτρινο | *utility yellow*  
12 cm  
pack: 1



47.38825 γενικής χρήσης πράσινο | *utility green*  
12 cm  
pack: 1



47.40567 γενικής χρήσης οδοντωτό μαύρο  
*utility wavy edge black*, 12 cm  
pack: 1



47.38826 γενικής χρήσης, μαύρο | *utility black*  
15 cm  
pack: 1



47.39350 γενικής χρήσης, κίτρινο | *utility yellow*  
15 cm  
pack: 1



47.38828 γενικής χρήσης, πράσινο | *utility green*  
15 cm  
pack: 1



47.38860 ντομάτας, μαύρο | *tomato black*,  
12 cm  
pack: 1



47.38830 φιλεταρίσματος ψαριού μπλε | *fish filleting blue*  
18 cm  
pack: 1



47.39294 φιλεταρίσματος ψαριού μπλε | *fish filleting blue*  
20 cm  
pack: 1



47.38839 chef's μαύρο | *chef's black*,  
18 cm  
pack: 1



47.38842 chef's πράσινο | *chef's green*,  
18 cm  
pack: 1



47.38844 chef's μαύρο | *chef's black*,  
20 cm  
pack: 1



47.38847 chef's πράσινο | *chef's green*,  
20 cm  
pack: 1



47.39360 chef's οδοντωτό μαύρο | *chef's wavy edge black*  
20 cm  
pack: 1

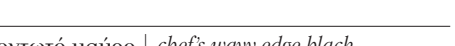

47.38849 chef's μαύρο | *chef's black*, 25 cm  
pack: 1



47.38852 chef's, πράσινο | *chef's green*, 25 cm  
pack: 1





47.40569 chef's οδοντωτό πράσινο | *chef's wavy edge green*  
25 cm  
pack: 1



47.38859 chef's granton μαύρο | *chef's granton edge black*  
25 cm  
pack: 1



47.38855 chef's μαύρο | *chef's black, 30 cm*  
pack: 1



47.38858 chef's, πράσινο | *chef's green, 30 cm*  
pack: 1



47.39495 Santoku, granton edge,  
μαύρο | *bread white, 20 cm*  
pack: 1



47.38702 ψωμιού λευκό | *bread white, 20 cm*  
pack: 1



47.38703 ψωμιού λευκό | *bread white, 25 cm*  
pack: 1



47.39132 ψωμιού μαύρο | *bread black, 25 cm*  
pack: 1



47.38721 ζαχαροπλαστικής λευκό | *pastry white*  
25 cm  
pack: 1



47.39141 ζαχαροπλαστικής μαύρο | *pastry black*  
25 cm  
pack: 1



47.40570 ζαχαροπλαστικής πριονωτό λευκό  
confectionery, 30 cm  
pack: 1



47.38713 slicing οδοντωτό λευκό | *slicing wavy edge*  
30 cm  
pack: 1



47.38714 slicing οδοντωτό λευκό | *slicing wavy edge*  
36 cm  
pack: 1



47.39351 ζαμπόν μαύρο | *ham slicing black, 24 cm*  
pack: 1



47.39352 ζαμπόν μαύρο | *ham slicing black, 30 cm*  
pack: 1



47.38831 σολομού μπλε | *salmon bleu, 30 cm*  
pack: 1



47.39139 ψητού μαύρο | *carving black, 20 cm*  
pack: 1















47.39140 ψητού μαύρο | *carving black, 25 cm*  
pack: 1





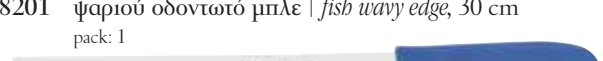
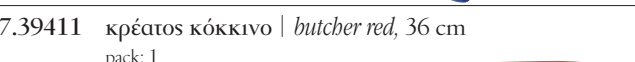

47.39365 ψητού οδοντωτό μαύρο  
*carving wavy edge black, 25 cm*  
pack: 1







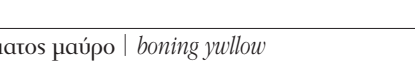



## «Safe»

- 47.38196 κρέατος κόκκινο | *butcher red*, 16 cm  
pack: 1 
- 47.39366 κρέατος μαύρο | *butcher black*, 16 cm  
pack: 1 
- 47.38198 κρέατος κόκκινο | *butcher red*, 20 cm  
pack: 1 
- 47.37342 κρέατος κίτρινο | *butcher yellow*, 20 cm  
pack: 1 
- 47.37375 ψαριού μπλε | *butcher/fish blue*, 20 cm  
pack: 1 
- 47.38832 fish filleting μπλε | *fish filleting blue*, 20 cm  
pack: 1 
- 47.38200 κρέατος κόκκινο | *butcher red*, 24 cm  
pack: 1 
- 47.37344 κρέατος κίτρινο | *butcher yellow*, 24 cm  
pack: 1 
- 47.38199 κρέατος, κόκκινο | *butcher red*, 26 cm  
pack: 1 
- 47.38201 ψαριού οδοντωτό μπλε | *fish wavy edge*, 30 cm  
pack: 1 
- 47.39411 κρέατος κόκκινο | *butcher red*, 36 cm  
pack: 1 
- 47.38962 ξεκοκαλίματος κόκκινο | *boning red*,  
13 cm  
pack: 1 
- 47.37611 ξεκοκαλίματος κίτρινο | *boning yellow*  
13 cm  
pack: 1 
- 47.37619 ξεκοκαλίματος κόκκινο | *boning red*  
15 cm  
pack: 1 
- 47.37631 ξεκοκαλίματος μπλε | *boning blue*  
15 cm  
pack: 1 

- 47.37617 ξεκοκαλίματος κόκκινο | *boning red*  
15 cm  
pack: 1 
- 47.37604 ξεκοκαλίματος κίτρινο | *boning yellow*  
15 cm  
pack: 1 
- 47.39029 ξεκοκαλίματος κόκκινο | *boning red*  
18 cm  
pack: 1 
- 47.39030 ξεκοκαλίματος κόκκινο | *boning red*  
20 cm  
pack: 1 
- 47.37606 ξεκοκαλίματος κίτρινο | *boning yellow*  
20 cm  
pack: 1 
- 47.37607 ξεκοκαλίματος μαύρο | *boning yellow*  
15 cm  
pack: 1 

## «Practica»

- 47.32040 λαχανικών μαύρο | *vegetable black*, 8 cm  
pack: 1 
- 47.30113 κουζίνας μαύρο | *paring black*, 9 cm  
pack: 1 
- 47.32294 κουζίνας μαύρο | *paring black*, 10 cm  
pack: 1 
- 47.30115 κουζίνας οδοντωτό μαύρο  
*paring wavy edge black*, 9 cm  
pack: 1 
- 47.34161 κουζίνας οδοντωτό μαύρο  
*paring wavy edge black*, 10 cm  
pack: 1 
- 47.32295 ίσιο/πριονωτό μαύρο | *half wavy edge black*  
10,5 cm  
pack: 1 
- 47.34336 λαχανικών  
με 2 λαβές, μαύρο,  
*vegetable with 2 handles*  
*black*, 27 cm  
pack: 1 
- 47.32041 πίτσας | *cheese/pizza*  
38 cm  
pack: 1 





47.32376 κρέατος μαύρο | *butcher black*, 30 cm  
pack: 1



47.35906 slicing μαύρο | *slicing black*, 36 cm  
pack: 1



47.38939 τυριού μαύρο | *cheese black*, 30 cm  
pack: 1



47.38942 τυριού μαύρο | *cheese black*, 36 cm  
pack: 1



47.38948 τυριού μαύρο | *cheese black*, 32 cm  
pack: 1



47.37902 μπαλντάς μαύρος | *cleaver black*, 15 cm  
pack: 1



47.30842 μπαλντάς μαύρος | *cleaver black*, 20 cm  
pack: 1



47.30836 μπαλντάς μαύρος | *cleaver black*, 23 cm  
pack: 1



47.30838 μπαλντάς μαύρος | *cleaver black*, 25 cm  
pack: 1



30.40283 κουζίνας | *paring*, 9 cm  
pack: 1



30.40284 γενικής χρήσης | *utility*, 15 cm  
pack: 1



30.40285 ξεκοκαλιώματος | *boning*, 20 cm  
pack: 1



30.40286 ψωμιού | *bread*, 21,5 cm  
pack: 1



30.40281 chefs, 20 cm  
pack: 1



30.40280 chefs, 25 cm  
pack: 1



30.40303 ψητού | *carving*, 25 cm  
pack: 1



30.40304 «santoku» granton edge, 18 cm  
pack: 1



30.41730 σολομού/ζαμπόν | *bam/salmon*, 30 cm  
pack: 1



30.40282 πιρούνα ψητού | *carving fork*, 15 cm  
pack: 1





μαχαίρια κουζίνας | *kitchen knives*

HACCP

HENDI

30.40162 κρέατος κόκκινο | *butcher red, 15 cm*  
pack: 1



30.42007 chef's καφέ | *chef's brown, 24 cm*  
pack: 1



30.40163 φιλεταρίσματος κόκκινο | *filleting red, 15 cm*  
pack: 1



30.40161 σολωμού καφέ | *salmon brown, 35 cm*  
pack: 1



30.42005 chef's κόκκινο | *chef's red, 18 cm*  
pack: 1



30.40168 chef's άσπρο | *chef's white, 24 cm*  
pack: 1



30.40164 chef's κόκκινο | *chef's red, 24 cm*  
pack: 1



30.42008 ψωμιού άσπρο | *bread white, 25 cm*  
pack: 1



30.40165 φιλεταρίσματος κίτρινο | *filleting yellow, 15 cm*  
pack: 1



30.40169 ψωμιού άσπρο | *bread white, 30 cm*  
pack: 1



30.40166 chef κίτρινο | *chef's yellow, 18 cm*  
pack: 1



30.41809 chef's κίτρινο | *chef's yellow, 24 cm*  
pack: 1



30.40159 φιλεταρίσματος μπλε | *filleting blue, 15 cm*  
pack: 1



30.41810 chef μπλε | *chef's blue, 18 cm*  
pack: 1



30.40160 chef's μπλε | *chef's blue, 24 cm*  
pack: 1



30.42004 γεν. χρήσης πράσινο | *universal green, 9 cm*  
pack: 1



30.41808 γεν. χρήσης οδοντωτό πράσινο | *universal serrated green, 10 cm*  
pack: 1



30.40167 λαχανικών πράσινο | *vegetable green, 24 cm*  
pack: 1



σετ χρωματιστά μαχαίρια | *set of colored knives*



HACCP

HENDI

30.40170 σετ 6 χρωματιστά μαχαίρια κουζίνας πράσινο, μαύρο, λευκό, κόκκινο, μπλε, κίτρινο  
*set of 6 colored paring knives green, black, white, red, blue, yellow*  
7,5 / 17,5 cm  
pack: 1



HACCP

30.40171 σετ 6 χρωματιστά μαχαίρια κουζίνας πράσινο, μαύρο, λευκό, κόκκινο, μπλε, κίτρινο  
*set of 6 colored paring knives green, black, white, red, blue, yellow*  
9 / 18,5 cm  
pack: 1

μαχαίρια κουζίνας | *kitchen knives*

30.41466 ξεκοκαλίματος μαύρο | *boning black*, 15 cm  
pack: 1



30.41467 φιλεταρίσματος μαύρο | *filleting black*, 15 cm  
pack: 1



μαχαίρια κουζίνας | *kitchen knives*

30.41937 ίσιο μαύρο | *straight, black*, 7,5 cm  
pack: 1



30.41049 κουζίνας μαύρο | *paring black*, 8,7 cm  
pack: 1



30.40966 καμπύλωτό μαύρο | *curved black*, 6 cm  
pack: 1



30.40296 ντομάτας μαύρο | *tomato black*, 11 cm  
pack: 1



HENDI μονοκόμματο forged ανοξείδη «*kitchen line*»

30.40528 *chefs*, 20 cm  
pack: 1



30.40529 *chefs*, 15 cm  
pack: 1



30.40530 ψητού | *carving*, 20 cm  
pack: 1



30.40531 ξεκοκαλίματος | *boning*, 15 cm  
pack: 1



30.40532 ψωμιού | *bread*, 23 cm  
pack: 1



30.40533 κουζίνας | *kitchen*, 12,5 cm  
pack: 1



30.40534 παπαγαλάκι | *paring*, 9 cm  
pack: 1



30.41804 πιρούνα ψητού | *carving fork*, 17,5 cm  
pack: 1



30.42001 μπαλτάς | *cleaver*, 18 cm  
pack: 1



θήκες μαχαιριών | *knives cases*

HENDI



30.41470 θήκη 10 μαχαιριών  
*case for 10 knives*  
51x17x5 cm  
pack: 1

GenWare



34.60011 θήκη 10 μαχαιριών  
*case for 10 knives*  
pack: 1



47.39288 θήκη 6 μαχαιριών  
*case for 6 knives*  
pack: 1

47.39290 θήκη 15 μαχαιριών  
*case for 15 knives*  
pack: 1



GenWare

\*34.60163 θήκη/κουτί μαχαιριών  
32100 9 θέσεων, st. steel  
*st. steel knife box*  
(7 μαχαίρια/knives -  
2 μασότι/sharpening steels)  
30,5x6,5 cm | 30,5 cm  
pack: 1

HENDI μαγνήτες μαχαιριών | *magnetic knife holder*



30.40535 με 3 γάντζους/*with 3 hooks*  
30 cm  
pack: 1

30.40687 με 5 γάντζους/*with 5 hooks*  
45 cm  
pack: 1

30.40688 με 6 γάντζους/*with 6 hooks*  
60 cm  
pack: 1

## «Poly»

- 47.38006 μπαλντάς μαύρος | *cleaver black, 27 cm*  
pack: 1
- 47.38007 μπαλντάς μαύρος | *cleaver black, 30 cm*  
pack: 1
- 47.38009 μπαλντάς μαύρος | *cleaver black, 32 cm*  
pack: 1
- 47.38008 μπαλντάς μαύρος | *cleaver black, 34 cm*  
pack: 1



- 47.38602 μπαλντάς κόκκινος | *cleaver red, 30 cm*  
pack: 1



- 47.39291 πριόνι | *butcher bow saw, 45 cm*  
pack: 1

- \*47.39293 ανταλλακτική λάμα | *spare blade*  
940.7040.40 pack: 1



## «Butcher»



- 47.39367 σφαγείου μαύρο, 25 cm  
*breaking knife black*  
pack: 1



- 47.37613 γδαρίματος μαύρο, 18 cm  
*skinning knife black*  
pack: 1



- 47.39905 τριπήματος μαύρο, 22 cm  
*sticking knife black*  
pack: 1



## κρεατομηχανή | *meat mincer*



- 35.00251 κρεατομηχανή με 3 δίσκους και χωνί για λουκάνικο  
*meat mincer with three cutting blades, sausage making attachments*  
pack: 1/4

KitchenCraft

## εργαλεία κρέατος | *meat tools*



GenWare

- \*34.60129 βάρος για steak  
cast iron (μαντέμι)  
*cast iron steak weight*  
10,8x21 cm  
pack: 1



μπάτνς | *meat maller*

- 19.55013 600 gr  
pack: 1

- 19.55014 1,5 kgr  
pack: 1



HENDI

- 30.40191 σφυρί κρέατος (ανάγλυφη όψη για χοιρινό/βοδινό και λεία για ψάρι/κοτόπουλο)  
*meat hammer (spiked surface for pork and beef - plain surface for fish and poultry)*  
22 cm  
pack: 1/12



HENDI

- 30.40116 τρυφεροποιητής κρέατος με 52 λάμμες  
*meat tenderizer with 52 blades*  
14,5x45x10 cm  
pack: 1

HENDI

τοιγκέλια (σετ 4) | *butcher books (set 4)*

- 30.40693 11x5 cm  
pack: 1

- 30.40694 15x6 cm  
pack: 1



HENDI

- κουβάρι σπάγγου βαμβακερό  
*roulable string made of unbleached cotton*  
30.40686 85 m (100 gr)  
pack: 1
- 30.42022 140 m (100 gr)  
pack: 1



KitchenCraft

- 35.00492 σύριγγα αρωματισμού με δύο βελόνες  
*st. steel flavour injector with a choice of two nozzles*  
pack: 1/6

- 30.41977 πρέσα για μπιφτέκια αντικολλητική  
*bamburgers press, non-stick*  
12 cm | 8 cm  
pack: 1



## DIAMOND CAMS

Διπλό ακονιστήρι με επίστρωση διαμαντιού. Πατενταρισμένο για να ελέγχεται με ακρίβεια η γωνία ακονίσματος. Για όλα τα μαχαίρια ανεξαρτήτως προέλευσης. Τρία στάδια ακονίσματος. Περιέχονται οδηγίες χρήσεως.

*The patent pending Diamond Cams control the edge angle very accurately as you swipe the blade down and back between the cams, for a highly refined cutting edge shape with a perfect hone ever time*



25.00240 «Trium»  
4290.02 pack: 1

Το επαναστατικό τετράγωνο μασάτι με επιστρώσεις διαμαντιών και ενσωματωμένο ακονιστήρι τύπου Cam™ με επίστρωση διαμαντιών. Πέντε στάδια ακονίσματος.

*The QUINTUM produces sharper knives in less time than traditional methods for better results for chefs and butchers, and easy pro results for home cooks : Diamond Cams in handle for full regrind of worn edges + 4 more stages of finer sharpening on steel shaft, 2 diamond and 2 hard chrome surfaces*

25.00242 «Quintum»  
4291.00 pack: 1



Ακονιστήρι μαχαριών με εργονομική λαβή και αντιολισθητική βάση. 3 δυνατότητες ακονίσματος, τραχύ και λεπτό για μεταλλικά μαχαίρια, και ακόνισμα κεραμικών μαχαριών

*Ergonomic handle and non-slip base. 3 functions for sharpening all kinds of knives, even ceramic knife. • Coarse: carbide sharpener for a precision edge every time. • Fine: crossed ceramic rods for professional grade edge honing. • Ceramic: crossed electroplated rods for ceramic knives.*

30.40690 20x46 cm | 7,5 cm  
pack: 1



ακονιστήρι με λάμα από βολφράμιο (από τα σκληρότερα υλικά) και προστατευτικό δακτύλων, 14 cm  
*knife sharpener, it's finger protection, reversible double sharpening blades made of carbide.*

30.41207 pack: 1

 HENDI



## ακονιστήρια - μασάτι | *knife sharpeners*



96.35072 μασάτι μαύρο στρογγυλό  
7.8303 *knife sharpener black round, 25 cm*  
pack: 1

 VICTORINOX

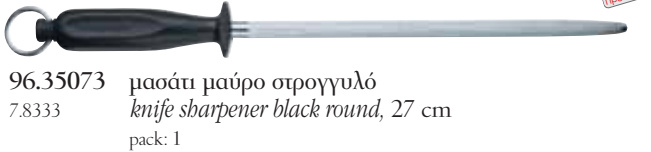

96.35073 μασάτι μαύρο στρογγυλό  
7.8333 *knife sharpener black round, 27 cm*  
pack: 1

 VICTORINOX

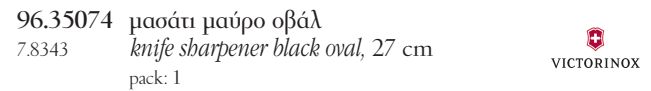

96.35074 μασάτι μαύρο οβάλ  
7.8343 *knife sharpener black oval, 27 cm*  
pack: 1

 VICTORINOX



96.35075 μασάτι κόκκινο οβάλ  
7.8623 *knife sharpener red oval, 30 cm*  
pack: 1

 VICTORINOX



47.39292 μασάτι μαύρο | *knife sharpener, 30 cm*  
pack: 1



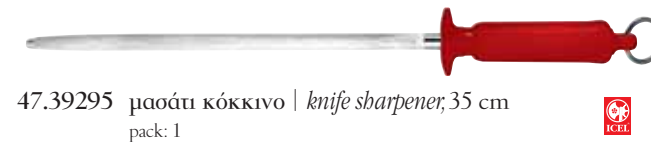

47.39295 μασάτι κόκκινο | *knife sharpener, 35 cm*  
pack: 1



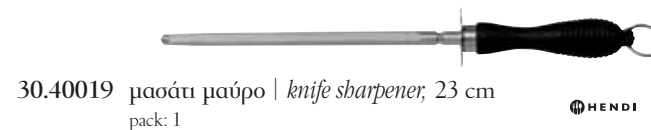

30.40019 μασάτι μαύρο | *knife sharpener, 23 cm*  
pack: 1

 HENDI

 HENDI

## πάγκος κοπής | *butcher block*









30.40695  
πάγκος κοπής st. steel  
*butcher block*  
block HDPE  
stand: 50x40x75 cm  
block: 50x40x8 cm  
pack: 1

ψαλίδια κουζίνας | *kitchen shears*

	10.40803 ψαλίδι πουλερικών <i>poultry shears</i> 27 cm pack: 6
	30.40692 ψαλίδι πουλερικών υψηλής αντοχής με μαλακή λαβή <i>poultry shears, high carbon steel, softgrip</i> , 24 cm pack: 6
	47.32998 ψαλίδι ψαριού <i>fish shears</i> 20 cm pack: 1
	47.34801 ψαλίδι γενικής χρήσης <i>multipurpose kitchen shears</i> pack: 6
	ψαλίδι γενικής χρήσης διαχωρίζεται για εύκολο καθαρίσμα <i>multipurpose kitchen shears detachable, easy to clean</i> 30.40305 19,5 cm pack: 1
	ψαλίδι γενικής χρήσης, st. steel/PP διαχωρίζεται για εύκολο καθαρίσμα, μαλακό πάσιμο <i>multipurpose kitchen shears detachable, easy to clean, softgrip</i> 30.41469 19,5 cm pack: 1
	47.39393 ψαλίδι επαγγελματικό <i>forged professional shears</i> 20 cm pack: 1

ράβδοι λογαριασμών | *tab grabber*

	ράβδοι λογαριασμών αλουμινίου- <i>glossy aluminium tab grabber</i>
	30.42218 45,5 cm pack: 1
	30.41979 91,5 cm pack: 1
	30.40891 61 cm pack: 1
	30.42219 101,5 cm pack: 1
	30.42220 122 cm pack: 1

εργαλεία ψαριού | *fish tools*

	47.32050 απολεπιστής ψαριών <i>fish scaler</i> , 19 cm pack: 1
	47.36730 μαχαίρι στρειδιών, μαύρο <i>oyster knife, black</i> 5 cm pack: 1
	*25.00374 ψαλίδι οστρακοειδών 4685.00 κόβει χωρίς να θρυματίζει και αφήνει ανέπαφο το περιεχόμενο <i>seafood shears cut hard shellfish leaving meat intact, without cracking normess</i> pack: 1
	*25.40040 κόπτης αχινών N4174 <i>sea urchin cutter</i> 23 cm pack: 1
	47.39395 ψαλίδι οστρακοειδών με ελατήριο <i>shellfish with spring</i> pack: 1
	47.39394 ψαλίδι καθαρισμού γαρίδων/κοιλιάς ψαριών <i>evisceration of fish and shrimp shear</i> pack: 1
	λαβίδες για κόκαλα ψαριών, st. steel <i>fish bone tweezers</i>
	30.41186 12 cm για λεπτά κόκαλα <i>slanted head</i> pack: 1
	30.41187 13 cm για χοντρά κόκαλα <i>flat head</i> pack: 1
	30.42251 10 cm μικρή με ίσια άκρη <i>small flat head</i> pack: 1
	30.42252 15,5 cm με μυτερή άκρη <i>point head</i> pack: 1
	30.42197 πένσα αστακών/καβουριών <i>lobster and crab cracker</i> 14x6,2 cm pack: 1
	30.42196 πένσα θαλασσινών <i>seafood cracker</i> 16x3,5 cm pack: 1



 <p>HENDI</p>	<p>30.40179 σετ γάντια βαμβακερά <i>oven mitts, cotton</i> 34,5 cm - 250°C pack: 1</p>	 <p>KitchenCraft</p>	<p>35.01237 σετ γάντια φούρνου με γραμμές σιλικόνης, <i>professional oven gloves with added heat resistant silicone ridges for a sure grip</i> 350°C pack: 1/6</p>
 <p>HENDI</p>	<p>30.41082 σετ γάντια βαμβακερά πυροπροστασίας <i>oven mitts, flame retardant cotton</i> 38 cm - 250°C pack: 1</p>	 <p>HENDI</p>	<p>30.41208 σετ γάντια φούρνου με άνετη εφαρμογή <i>heat resistant oven gloves</i> 30 cm, 500°C pack: 1/6</p>
 <p>HENDI</p>	<p>30.41471 σετ γάντια φούρνου δερμάτινα, <i>oven mitts, leather made from cow leather.</i> 46 cm - 250°C pack: 1</p>	 <p>ICET</p>	<p>γάντι ασφαλείας, πλεκτό, μεταλλικό <i>mesh safety glove</i> *47.40582 small pack: 1 *47.40581 medium pack: 1 *47.40580 large pack: 1</p>
 <p>HENDI</p>	<p>30.41912 σετ γάντια φούρνου δερμάτινα, <i>oven mitts, leather made from cow leather.</i> 46 cm - 450°C pack: 1</p>	 	<p>cut resistance ιδανικά για επαφή και χειρισμό κοφτερών αντικειμένων πλέξη από ΗΡΡΕ, πολυεστερικές ίνες και νάιλον που καθιστά τα γάντια ανθεκτικά και άνετα. Αντίσταση κοπής επιπέδου 4. Αντίσταση τριβής επιπέδου 3. <i>ideal for use during cutting and handling sharp objects, the mix of HPPE, polyester fibres and nylon makes these gloves durable and comfortable.</i> Level 4 cut resistance. Level 3 abrasion resistance. 30.41472 pack: 1</p>
 <p>HENDI</p>	<p>30.40696 σετ γάντια φούρνου με fiberglass και έξτρα προστασία από τα υγρά <i>set oven mitts with fiberglass and extra protection</i> 43 cm - 350°C pack: 1</p>		
 <p>KitchenCraft</p>	<p>35.01605 γάντι σιλικόνης, δεν γλιστρά, προστασία από θερμότητα και ατμούς <i>Silicone oven glove</i> pack: 1/6</p>		

 <p>HENDI</p>	<p>30.41206 βούρτσα PP 8 σειρές σιδερένια σύρματα και ξύστια <i>wire brush, PP with 8 rows of steel wire. Steel scraper</i> 7x8 cm   19 cm pack: 1</p>	 <p>HENDI</p>	<p>30.40208 σετ 2 βούρτσες με 3 σειρές σύρματα <i>set of 2 wire brushes, wood with 3 rows of wire</i> 29 cm pack: 1</p>
 <p>HENDI</p>	<p>30.41983 βούρτσα PP 8 σειρές σιδερένια σύρματα και ξύστια <i>wire brush, PP with 8 rows of steel wire. Steel scraper and long handle</i> 7x8,5 cm   31 cm pack: 1</p>	 <p>HENDI</p>	<p>30.41711 σετ 2 βούρτσες συρματινή &amp; ορείχαλκου 4 σειρές σύρματα <i>set of 2 wire brush, brass &amp; stainless steel, wood with 4 rows of wire</i> 29 cm pack: 1</p>
 <p>HENDI</p>	<p>30.40208 βούρτσα συρματινή με πλαστική λαβή <i>black plastic handle with steel bristles</i> 15x5,5 cm pack: 1</p>	 <p>HENDI</p>	<p>30.40185 ξύστρα για ταψιά και επιφάνειες ψησίματος <i>griddle scraper</i> 10 cm   31,5 cm pack: 1</p>

δίσκοι κοπής GN HDPE  
2 όψεων (η μία με αυλάκι) πάχους 1,5 cm  
HDPE cutting boards GN  
one side smooth and other side with groove GN 1/1

GN 1/1



δίσκοι κοπής HDPE GN 1/1  
HDPE cutting boards GN 1/1  
53x32,5 | 1,5 cm

- 30.40235 ● κόκκινος | red  
pack: 1
- 30.40239 ● μπλε | blue  
pack: 1
- 30.40234 ○ λευκός | white  
pack: 1
- 30.40237 ● καφέ | brown  
pack: 1
- 30.40236 ● πράσινος | green  
pack: 1
- 30.40238 ● κίτρινος | yellow  
pack: 1

δίσκοι κοπής HDPE cutting boards 60x40 cm

HENDI

60x40



δίσκοι κοπής HDPE  
HDPE cutting boards  
60x40 cm | 1,8 cm

- 30.41448 ● κόκκινος | red  
pack: 1
- 30.41729 ● μπλε | blue  
pack: 1
- 30.41449 ○ λευκός | white  
pack: 1
- 30.41445 ● καφέ | brown  
pack: 1
- 30.41447 ● κίτρινος | yellow  
pack: 1
- 30.41446 ● πράσινος | green  
pack: 1
- 30.41803 ● μοβ | purple  
pack: 1

δίσκοι κοπής GN HDPE  
2 όψεων (η μία με αυλάκι) πάχους 1,5 cm  
HDPE cutting boards GN  
one side smooth and other side with groove GN 1/2

GN 1/2



δίσκοι κοπής HDPE GN 1/2  
HDPE cutting boards GN 1/2  
26,5x32,5 | 1,2 cm

- 30.40699 ● κόκκινος | red  
pack: 1
- 30.40700 ● μπλε | blue  
pack: 1
- 30.40698 ○ λευκός | white  
pack: 1
- 30.40702 ● καφέ | brown  
pack: 1
- 30.40701 ● πράσινος | green  
pack: 1
- 30.40703 ● κίτρινος | yellow  
pack: 1

HENDI

δίσκοι κοπής HDPE cutting boards 45x30 cm

HENDI

45x30



δίσκοι κοπής HDPE  
HDPE cutting boards  
45x30 cm | 1,27 cm

- 30.40174 ● κόκκινος | red  
pack: 1
- 30.40175 ● μπλε | blue  
pack: 1
- 30.40173 ○ λευκός | white  
pack: 1
- 30.40177 ● καφέ | brown  
pack: 1
- 30.40178 ● κίτρινος | yellow  
pack: 1
- 30.40176 ● πράσινος | green  
pack: 1
- 30.41234 ● μοβ | purple  
pack: 1

δίσκοι κοπής HDPE cutting boards GN 1/2

HENDI

GN 1/2



δίσκοι κοπής HDPE GN 1/2  
HDPE cutting boards GN 1/2  
26,5x32,5 | 0,9 cm

- 30.41413 ● κόκκινος | red  
pack: 6
- 30.41414 ● μπλε | blue  
pack: 6
- 30.41412 ○ λευκός | white  
pack: 6
- 30.41416 ● καφέ | brown  
pack: 6
- 30.41417 ● κίτρινος | yellow  
pack: 6
- 30.41415 ● πράσινος | green  
pack: 6

σταντ δίσκων κοπής | cutting board rack

HENDI



- 30.40190 σταντ δίσκων κοπής  
για 6 δίσκους  
cutting board rack,  
for 6 cutting boards  
30,3x21,1 | 20,5 cm  
pack: 1/12

δίσκοι κοπής | *cutting boards*

εύκαμπτες επιφάνειες κοπής | *flexible cutting mat*

HENDI



δίσκοι κοπής ξύλινοι (rubberwood)  
με λαβές  
*cutting boards rubberwood with handles*

30.40056 GN 1/2 26,5x32,5 cm | 4,5 cm  
pack: 1

30.40057 GN 1/1 53x32,5 cm | 4,5 cm  
pack: 1

HENDI



30.40706 δίσκος κοπής με αυλάκι  
από ξύλο οξιάς  
*cutting board with groove,  
solid beech wood*  
39x23x1,6 cm  
pack: 1

HENDI

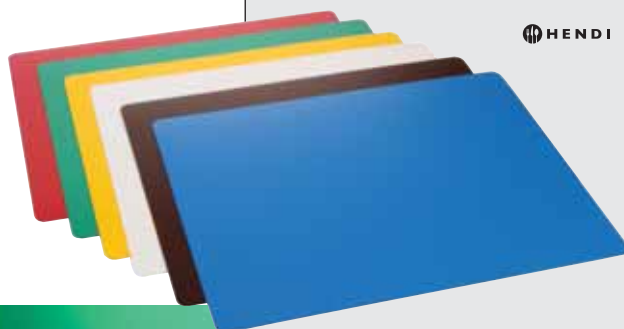

30.40058 σετ 6 εύκαμπτες  
επιφάνειες κοπής  
6 χρωμάτων (λευκό,  
κόκκινο, μπλε, πράσινο,  
καφέ και κίτρινο)  
*flexible cutting mat  
set of 6 colour coded mats  
(white, red, blue, green,  
brown, yellow)*  
38x30,5x0,14 cm  
pack: 1

HACCP



αντιολισθητικό πανί | *antislip mat*

HENDI



30.40544 αντιολισθητικό PVC  
υπόστρωμα δίσκων  
παρέχει οικονομία  
μετατρέποντας όλους  
τους δίσκους σε  
αντιολισθητικούς  
*antislip mat, made of PVC  
foam, easy to cut to size*  
30 cm | 1,5 m  
pack: 1



σελίδες 292-295  
BUFFET-SERVIVE

για ξύλινα πλατό - cutting boards ανατρέξτε





# Pasta



**HENDI**  
30.41205  
44x38,2 cm | 34 cm  
pack: 1

χειροκίνητη μηχανή ζυμαρικών με ρυθμιζόμενο πάχος ζύμης με 7 βήματα από 0,2 έως 2,5 mm και μέγιστο πλάτος 14 cm, 3 κύλινδροι/κοπτήρες αλουμινίου για ζύμη, ταλιατέλες, φετουτσίνι

*Pasta maker. Dough thickness adjustable in 7 steps from 0,2 to 2,5 mm. Three aluminium alloy rollers/cutters: dough roller, tagliatelle cutter and fettuccine cutter. Includes a hand crank and a clamp for table mounting.*



«Cuocipasta»

PINTINOX

*Μια έξπνη, βολική λειτουργική ιδέα για ταυτόχρονη παρασκευή 2, 4 ή 6 διαφορετικών ειδών πάστας και μακαρονιών. Η 30 lt χύτρα από inox 18/10 είναι ιδανική για όλες τις εστίες και για εστίες induction. Παρέχεται η δυνατότητα παραγγελίας κάθε εξαρτήματος ξεχωριστά.*

*A smart, convenient, functional concept for simultaneous preparation 2, 4 or 6 different types of pasta. The 30 liter 18/10 stainless steel kettle, is ideal for all hotplates and for induction foci. It is possible to order each component separately.*



**HENDI**  
30.41204  
25,8x21,8 cm | 23,2 cm  
pack: 1

ηλεκτρική μηχανή ζυμαρικών με ρυθμιζόμενο πάχος ζύμης με 9 βήματα από 0,2 έως 2,5 mm και μέγιστο πλάτος 17 cm, 3 κύλινδροι/κοπτήρες για ζύμη, ταλιατέλες 6,25 mm και φετουτσίνι 2 mm

*Perfect for making fresh pasta (max. width: 17 cm). Cover equipped with safety switch.*

*Dough thickness adjustable in 7 steps from 0,2 to 2,5 mm. Three rollers/cutters: dough roller, tagliatelle cutter (6,25 mm) and fettuccine cutter (2 mm).*



19.20084 «Cuocipasta 6»  
κατσαρόλα με καπάκι και 6 θήκες 2,5 lt  
kettle with lid and 6 sections 2,5 lt  
38x35 cm | 23,5 cm  
pack: 1



19.20083 «Cuocipasta 4»  
κατσαρόλα με καπάκι 3 θήκες 2,5 lt & 1 θήκη 7 lt  
kettle with lid and 3 sections 2,5 lt & 1 section 7 lt  
38x35 cm | 23,5 cm  
pack: 1



19.50550  
θήκη μακαρονιών 1/3  
pasta cooker basket 1/3  
20,5 cm (χύτρα/stew pan 34 cm)  
pack: 1

19.50548  
θήκη μακαρονιών 1/4  
pasta cooker basket 1/4  
26,5 cm (χύτρα/stew pan 40 cm)  
pack: 1

PINTINOX



**HENDI**  
30.40000  
θήκη μακαρονιών 1/4  
pasta cooker basket 1/4  
16x23 cm  
(χύτρα/stew pan 36 cm)  
pack: 1



\*19.20086 «Cuocipasta 2»  
κατσαρόλα με καπάκι και 2 θήκες 7 lt  
kettle with lid and 2 sections 7 lt  
38x35x23,5 cm  
pack: 1

## μαντολίνο «*Swing*» mandoline

de Buyer



μαντολίνο «Swing», μαύρο, πλήρες (πιεστής, δοχείο, οριζόντια διπλή micro-serrated οδοντωτή λάμα και μία juliene 4 & 10 mm) με σύστημα μετρήματος πάχους

*Complete mandoline with polymer composite, a double horizontal blade (straight & serrated) and a double Julienne blade (space 4 and 10 mm), black colour*

25.00384 40x20 cm  
2015.03 pack: 1

## μαντολίνο «*Revolution*» mandoline

de Buyer



Το γρηγορότερο μαντολίνο! Καινοτομία η νέα οριζόντια διπλή micro-serrated οδοντωτή λάμα. Η μία πλευρά είναι οδοντωτή και η άλλη γωνιακή κυματιστή. Τεμαχίζει μαλακά φλούδα με λεπτή φρούτα και λαχανικά αλλά και σκληρά με χονδρή φλούδα. Σώμα εξολοκλήρου από αλουμίνιο. Πλήρες μαντολίνο (πιεστής, θήκη φύλαξης, μία οριζόντια διπλή λάμα και τρεις juliene 2, 4 & 10 mm) Κόβει σε πολλαπλά σχήματα, καρτέ, ρόμβους, φέτες, κυματιστά, Julienne, waffle και πάχος από πάρα πολύ λεπτό μέχρι 1 cm.

*Complete Mandoline with receptacle & pusher with 1 double horizontal blade-straight/serrated and 3 Julienne blades 2-4-10 mm. st. steel pusher with rotating control system*

25.00263 38x10,5x13 cm  
2012.01 pack: 1

## μαντολίνο | mandoline

HENDI



μαντολίνο μαύρο, PP και ABS, πιεστής από ABS με 5 λεπίδες υψηλής από ποιότητας ασάλι (2 juliene), ρυθμιζόμενο πάχος 1-9 mm, αναδιπλούμενο και πόδια από καουτσούκ

*vegetable cutter V-type, made of hard black PP and ABS, including 5 high quality stainless steel blades, foldable stand with rubber feet, V-shaped main cutting blade, lades for julienne or french fries, 6 or 9 mm wide, adjustable slice thickness from 1-9 mm*

30.40710 33,5x13x7,5 cm  
pack: 1

## μαντολίνο Japanese «*Komi*» vegetable slicer

Ακριβής και αποτελεσματική, κοφτερή λεπίδα με γωνία 35°. Κόβει σε φέτες και σε Julienne 2/4 mm. Γρήγορη και εύκολη ρύθμιση πάχους από 0-5 mm. Εξοπλισμένο με εργονομικό πιεστή από διάφανο πλαστικό που προστατεύει τα δάχτυλά σας. Θήκη αποθήκευσης και πιεστή που αποθηκεύεται σε μικρό χώρο.

*Accurate and efficient: sharp blade with its 35°-angle. Multicut: slices & Julienne 2/4 mm. Quick and easy thickness adjustment. Graduated from 0 up to 5 mm. Equipped with an ergonomic protective food guard made of transparent plastic. Compact storage: integrated Julienne blades storage box & food guard.*

25.00659 2018.00  
Japanese μαντολίνο «Komi»  
Japanese vegetable slicer  
27x11,2 cm | 3,3 cm  
pack: 1

## μαντολίνο | mandoline

HENDI



μαντολίνο inox και μαύρο ABS, με 2 λεπίδες: μία τεμαχισμού V και μία κυματιστή, αναδιπλούμενο, πόδια με λάστιχο, με 2 επιπλέον λάμες juliene.

*vegetable cutter V-type double bladed, made of stainless steel and black ABS, V-shaped main slicing blade, crinkled secondary slicing blade, two extra blades for julienne or french fries, 6 or 9 mm wide.*

30.40709 53x16,5 cm | 20,3 cm  
pack: 1

## μαντολίνο τρούφας *truffles mandoline*



μαντολίνο τρούφας, ρυθμιζόμενο και ακριβές πάχος κοπής 0,1-4 mm

*truffles mandoline cutting width: 5,8 cm, adjustable and precise cutting thickness: 0,1 to 4 mm*

\*25.40003 18x7 cm | 1,5 cm  
1010CT pack: 1

## χορτομχανές | vegetable mills

**ΡΗΝΤΙΝΟΧ**



19.55012 χορτομχανή με 2 δίσκους  
*vegetable mill with 2 straining discs*  
42 cm | 19 cm  
pack: 1

**HENDI**



30.40245 χορτομχανή με 2 δίσκους  
*vegetable mill with 2 straining discs*  
20 cm  
pack: 1

**HENDI**



30.40246 χορτομχανή  
*vegetable strainer fine mesh*  
20 cm  
pack: 1

**LT**



\*25.40000 M530 μύλος χορταρικών με σίτα 3 mm (50 ατόμων)  
*tinned vegetable mill interchangeable sieve discs with sieve 3 mm (50 persons)*  
37 cm | 32 cm  
διατίθενται και δίσκοι 1-1,5-2-4 mm  
pack: 1

**LT**



\*25.40001 S3 μύλος χορταρικών με 3 δίσκους 1,5-2,5-4 mm (20 ατόμων)  
*tinned vegetable mill with 3 discs 1,5-2,5-4 mm (20 persons)*  
31 cm | 25 cm  
pack: 1

**LT**



\*25.40002 X3-F μύλος χορταρικών με 3 δίσκους 1,5-2,5-4 mm (20 ατόμων)  
*st. steel vegetable mill with 3 discs 1,5-2,5-4 mm (20 persons)*  
31 cm | 25 cm  
pack: 1

## κόπτες φρούτων λαχανικών | fruit cutters

**LT**



\*25.40006 N4232T αποφλοιωτής/τεμαχιστής μήλων, φέτες 4 mm, αφαιρεί το κέντρο του φρούτου, από χυτό ατσάλι  
*apple peeler - peels, slices and cores apples slice: 4 mm.*  
30,5x12 cm | 18,5  
pack: 1

## αποφλοιωτές φρούτων | vegetable peelers

**LT**



ηλεκτρικός αποφλοιωτής για εσπεριδοειδή, κρεμμύδια (στρογγυλά και ωσειδή φρούτα και λαχανικά) με ρύθμιση πάχους  
*electric peeler; plastic for citrus, onions, and all round and oval fruits, peeling thickness adjustable available and inox*  
50 Hz - 220V - 24 W  
25x16,5 cm | 23 cm

\*25.40032 πλαστικός | plastic  
N4221 pack: 1

\*25.40031 μεταλλικός | metallic  
N4220 pack: 1

## κόπτης λαχανικών | strip cutter

**LT**



\*25.40009 CLAN X κόπτης λαχανικών σε ταινία, με μοχλό λάμα 15 cm  
*strip cutter; blade: 15 cm maximum width and of the vegetable or fruit: 11-17cm. Fresh-cut and strip fruits and vegetables in ibin and large strips: revisit lasagna, spring rolls, terrine, millefeuille*  
25x23 cm | 42 cm  
pack: 1

διατίθεται και μοντέλο χωρίς μοχλό

**LT**



«Le rouet gourmet»  
\*25.40011 4100CLR κόπτης λαχανικών σε γιρλάντα, ρυθμιζόμενη λεπίδα και 3 μαχαίρια: 1-2-4 mm.  
*turning slicer, adjustable cutting thickness: 1-4 mm Adjustable blade (garlands) and 3 knives filaments: 1 mm, 2 mm, 4 mm.*  
36x13,5 cm | 24,3 cm  
pack: 1

## καθαριστής ανανά | pineapple peeler

**LT**



\*25.40012 EA095 καθαριστής ανανά καθαρίζει και αφαιρεί το κέντρο του ανανά με μια κίνηση (8,9 cm)  
*inox/HDPE pineapple peeler Peel and core the pineapple in only one movement. Security system. Use without physical effort.*  
45x39 cm | 72 cm  
pack: 1

πατατοκόπτης χυτού αλουμινίου με ανοξείδωτες λεπίδες κύβων 6, 9, 13 mm καθώς και για τεμαχισμό 8 κομματιών



french fries cutter,  
die-cast aluminium  
comes with 4 blades:  
6, 9 and 13 mm, as well as  
a knife for 8 parts,  
st. steel mounting plate allows  
easy removal and cleaning,  
with rubber feet to hold firmly  
when using on table

30.40022 43x17x29 cm  
pack: 1



see movie



ανταλλακτικές ατσάλινες λεπίδες  
spear part blades

30.40216 κύβων/thic fries 6 mm  
932902 pack: 1

30.40214 κύβων/thic fries 9 mm  
932919 pack: 1

30.41473 κύβων/thic fries 11 mm  
630419 pack: 1

30.40215 κύβων/thic fries 13 mm  
932926 pack: 1

30.40213 8 τεμαχιών  
932933 pack: 1

\*30.41298 ανταλλακτικά σετ 4  
αντιολισθητικά πόδια  
spear part 4 rubber feet  
pack: 1



τεμαχιστής λαχανικών | stick slicer



\*25.40008 τεμαχιστής λαχανικών  
CC10 για ράβδους, κύβους,  
πατάτες τηγανιτές  
με δίσκο 10x10 mm  
με μοχλό που μέγιστα  
αποτελέσματα  
stick slicer for sticks,  
french fries and dice  
leverage effect for increased  
efficiency  
disc 10x10 mm  
35,5x26 cm | 66 cm  
pack: 1

διατίθεται και με δίσκο 8x8 cm

τεμαχιστές ντομάτας | tomato slicers



τεμαχιστής ντομάτας  
100% st. steel, 10 φέτες πάχους 5 mm  
tomato slicer, 100% st. steel,  
10 slices 5 mm thick

30.40711 43,2x20,2 cm | 21 cm  
pack: 1

αποφλοιωτές λαχανικών | vegetable peelers



	96.35076 6.0912 VICTORINOX	αποφλοιωτής inox inox vegetable peeler 11x6,5 cm pack: 1
	96.35077 7.6075 VICTORINOX	αποφλοιωτής μαύρος vegetable peeler black 21,2x4,9 cm pack: 1
	96.35078 7.6079 VICTORINOX	αποφλοιωτής μαύρος οδοντωτός peeler serrated black 17,5x7,6 cm pack: 1
	96.35079 7.6079.1 VICTORINOX	αποφλοιωτής κόκκινος οδοντωτός peeler serrated red 17,5x7,6 cm pack: 1
	96.35080 7.6079.4	αποφλοιωτής πράσινος οδοντωτός peeler serrated green 17,5x7,6 cm pack: 1

εργαλεία διακόσμησης | carving

	*25.40052 ID1000 LT	σετ 2 μαχαίρια Thai εύκαμπτη λάμα 5,5 cm hardened steel thai carving knife fine and soft blade: 5.5 cm pack: 1
	*25.40053 ID2500 LT	σετ 18 εργαλείων διπλής αιχμής σε σχήματα «U», «V» και 3 γραφίδες st. steel 18 carving tools and whetstone 15 double chisels «U» & «V» shape and 3 stylus pack: 1
	25.40055 N7105V LT	κόπτης σπινάλ για πατάτες, καρότα, κ.ά deco pin, to make vegetables spiral with potatoes, turnip or carrots 23,5 cm pack: 1

αποφλοιωτές λαχανικών | vegetable peelers

	30.40297 HENDI	αποφλοιωτής st. steel st. steel peeler 5/15 cm pack: 1
	19.39015 78100096 VICTORINOX	αποφλοιωτής inox inox vegetable peeler pack: 1
	25.40033 N8013 LT	αποφλοιωτής inox διπλή λάμα για julienne castor julienne, double moving blade with straighten tooth for thin juliennes or zests 17,5x1,4 cm pack: 1
	30.40180 HENDI	αποφλοιωτής inox st. steel peeler 5x11 cm pack: 1
	*25.40035 N8015 LT	καθαριστής διπλής κατεύθυνσης, λάμα inox 4 cm pollux peeler, 4 cm useful double moving blade 17 cm pack: 1
	*25.40034 N8014 LT	καθαριστής διπλής κατεύθυνσης, inox για λεπτά και χνουδωτά φρούτα thin skin pollux peeler, double moving micro-serrated blade, peel every skins, even thin and hairy 17 cm pack: 1
	*25.40030 N3079 LT	καθαριστής σπαραγγιών asparagus peeler, inox 17,5x1,4 cm pack: 1

εκπιρννωτές | pitters

	25.40039 N4203 LT	καθαριστής ελιών και κερασιών non-stick aluminium olive and cherry pitter to take the core out from olives, cherries and mirabelles in one press. 15,3x6,7 cm pack: 1
	10.40040 GHIDINI ITALY	βουσινοκαθαριστής olive and cherry pitter inox, 16,5 cm pack: 1



κόπτες λαχανικών | vegetable cutters

 **\*25.40056** κόπτης για ραπανάκια  
N4197 *radish decorer*  
16,5x5,1 cm  
pack: 1

 **\*25.40015** τεμαχιστής για μανιτάρια  
N4194X  *slicer for mushrooms, strawberries, garlic, etc.*  
cut: 6 mm.  
22,5x7,3 cm  
pack: 1

 **\*25.40057** κόπτης κυματιστός  
ID4036 *curl cutter*  
10,3x8 cm  
pack: 1

 **\*25.40007** κόπτης μήλου  
N4206 *apple wedger*  
8 τεμαχιών  
8 wedges  
9 cm (17x10,3 cm)  
pack: 1

HENDI στραγγιστήρας σαλάτας | salad spinners

 **30.40032** 12 lt, 33 cm | 43 cm  
pack: 1  
**30.40033** 25 lt, 44 cm | 52 cm  
pack: 1

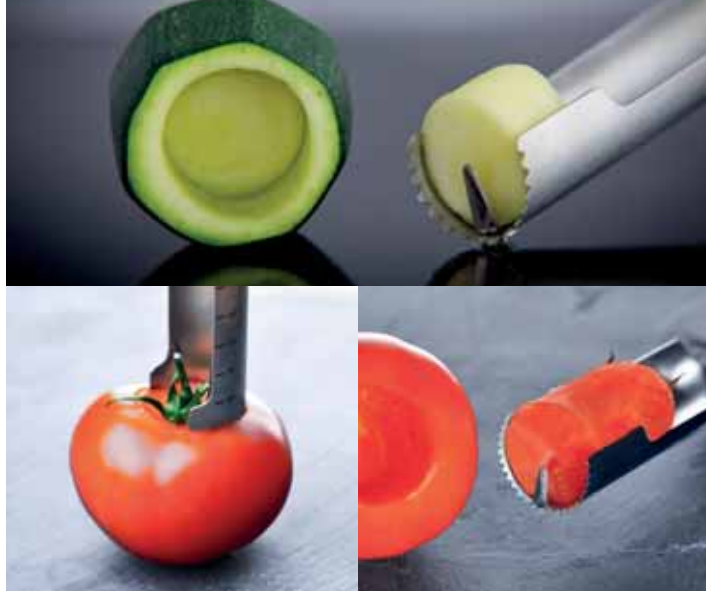

καθαριστές κέντρου φρούτων/λαχανικών  
*manual corer for fruits/vegetables*

 **\*25.00106** 12 mm πορτοκαλί  
2612.01 9 mm | 19,7 cm  
pack: 1  
**\*25.00107** 20 mm πράσινος  
2612.02 12 mm | 24,6 cm  
pack: 1  
**\*25.00664** 30 mm κόκκινος  
2612.03 12 mm | 25 cm  
pack: 1

 **\*25.40054** κόπτης πυρήνα  
ID1204 *λαχανικών / φρούτων για γεμιστά (3,4 cm)*  
10 λεπίδες, inox  
*vegetable cutter-corer*  
*Cut diameter: 3,4 cm.*  
*Cutter for scooping out the middle of fruit and vegetables for stuffing.*  
8,5x3,7 cm | 9 cm  
pack: 1

καθαριστές ανανά | pineapple peelers





 **35.01527** καθαριστής και κόπτης  
ανανά  
*pineapple peeler and slicer*  
pack: 1



πρέσες σκόρδου | *garlic presses*

	10.40513 πρέσα σκόρδου/ πολυεργαλείο <i>all purpose garlic press</i> 21 cm pack: 1
	10.40510 πρέσα σκόρδου αλουμινίου <i>aluminium garlic press</i> 13 cm pack: 1
	30.41133 πρέσα σκόρδου inox, με 2 σίτες <i>inox garlic press</i> <i>two removable grids</i> 18x2,5 cm pack: 1

πολτοποιητές πατάτας | *potato masher*

	10.40355 πολτοποιητής πατάτας <i>potato ricer</i> 31 cm pack: 12
	30.40713 πολτοποιητής πατάτας <i>potato ricer</i> 11 cm   30 cm pack: 1
	30.40635 πιεστήρας πατάτας, st. steel <i>st. steel potato masher</i> 13 cm   35,5 cm pack: 1
	30.41612 πιεστήρας πατάτας, st. steel <i>st. steel potato masher</i> 20x13 cm   71 cm pack: 1

λαδικά ανοξείδωτα | *oil jugs*

	<b>PKS</b> λαδικά   <i>st. stell oil jugs</i> 60.45000 13 cm   50 cl pack: 1/48
	60.45001 14,5 cm   70 cl pack: 1/48
	60.45002 18 cm   1,1 lt pack: 1/48
	<b>PKS</b> λαδικά   <i>st. stell oil jugs</i> 60.45018 17 cm   50 cl pack: 1/24
	60.45019 20 cm   70 cl pack: 1/24
	60.45020 24 cm   1 lt pack: 1/24

πώμα ροής | *free-flow pourer*

	30.42239 σετ 3 τμχ. πώματα ροής <i>free-flow pourer set of 3 pcs</i> pack: 1
---	---

κωνιά | *funnel*

	30.40031 κωνιά, inox <i>st. steel funnel</i> 12 cm pack: 1
	34.00165 mini κωνιά inox <i>mini funnel, st. steel</i> 5,5 cm pack: 6
	30.41173 κωνιά   <i>funnel</i> PP, 10 cm pack: 1
	30.41174 κωνιά   <i>funnel</i> PP, 12,7 cm pack: 1
	30.41175 κωνιά   <i>funnel</i> PP, 15 cm pack: 1







**35.01506** τρίφτης 4πλευρος, st. steel  
*st. steel grater, four sided*  
19 cm  
pack: 1



**34.00146** τρίφτης 4 πλευρών  
*st. steel grater, four sided*  
18 cm  
pack: 1



**35.01075** τρίφτης μπαχαρικών  
*nutmeg grater*  
13 cm  
pack: 1/6



**\*25.40027** τρίφτης σκόρδου  
*garlic grater*  
11x7,5 cm  
pack: 1



**30.40052** τρίφτης 4πλευρος, st. steel | *st. steel grater, four sided*  
9x6,5 cm | 20 cm  
pack: 1





**30.40715** τρίφτης λεπτός st. steel  
*fine rasp, st. steel*  
3,5x22 cm | 39 cm  
pack: 1





**30.40240** τρίφτης χοντρός st. steel  
*coarse rasp, st. steel*  
3,5x22 cm | 39 cm  
pack: 1



**30.40241** τρίφτης ξύσμα κορδέλλα  
*ribbon rasp, st. steel*  
3,5x22 cm | 39 cm  
pack: 1



**30.40242** τρίφτης χοντρός, st. steel  
*coarse rasp, st. steel*  
6,5x13,5 cm | 31,5 cm  
pack: 1

**30.40243** τρίφτης για ξύσμα  
*ribbon rasp, st. steel*  
6,5x13,5 cm | 31,5 cm  
pack: 1



**30.40244** τρίφτης λεπτές φέτες  
*shaver rasp, st. steel*  
6,5x13,5 cm | 31,5 cm  
pack: 1



## ανοιχτήρι κονσερβών | can opener



GHIDINI  
ITALY

10.40000 ανοιχτήρι «No 58»  
can opener  
pack: 12/72



GHIDINI  
ITALY

10.40012 ανοιχτήρι «No 78»  
can opener  
pack: 1/12



HENDI

ανοιχτήρι για κονσερβές  
(αφαιρεί το καπάκι χωρίς να αφήνει μυτερές αιχμές και επιτρέπει να επιστραφεί το καπάκι στην κονσερβή. – Ο μηχανισμός κοπής λειτουργεί κόβοντας την πλευρά της κονσερβας κάτω από το καπάκι.)  
safe can opener  
(removes the lid without leaving sharp edges and provides the possibility to place the lid back on the can. The cutting mechanism operates by cutting the side of the can just below the lid.)

30.42010 19 cm  
pack: 1



HENDI

30.40049 ανοιχτήρι για κονσερβές, st. steel,  
ιδανικό για κονσερβές έως 33,5 cm  
can opener, suitable for cans up to 33,5 cm  
pack: 1

30.41393 αναταλλακτικό γρανάζι | spear part gear  
pack: 1

## κόπτες τυριού | cheese slicers



«χορδές» τυριού, ιδανικές για τυριά,  
φουά γκρα, βούτυρο  
lyres, perfect to cut cheeses, foie gras, butter

25.40019 17 cm  
N3503 pack: 1

25.40020 21 cm  
N3504 pack: 1

αναταλλακτική χορδή | spare wires

24.40165 17 cm  
N35031 pack: 1

24.40166 21 cm  
N35041 pack: 1



\*25.40022 σετ 10 χορδές κόπτης  
st. steel  
set of 10 wires to cut cheese  
60 cm  
pack: 1



\*25.40021 κόπτης τυριού  
ανοξείδωτος με βάση  
φάρδος κοπής 14 cm  
για μαλακά τυριά  
cheese slicer with blade  
and board, for foie gras,  
butter, blue cheeses, etc.  
27x22,5 cm | 3 cm  
pack: 1

## εργαλεία αυγού | egg utensils



HENDI

30.40048 αυγοκόπτης οβάλ,  
αλουμινίου  
aluminium oval egg cutter  
12x11,5 cm  
pack: 1



HENDI

30.40892 αυγοκόπτης ορθογώνιος,  
αλουμινίου  
aluminium rectangular  
egg cutter  
13x8,5 cm | 3 cm  
pack: 1

εργαλεία για τρούφες | *truffles and mushrooms utelcils*





	<p>*25.40003 1010CT μαντολίνο τρούφας ρυθμιζόμενο (0,1-4 mm) <i>truffles mandoline adjustable: 0,1 to 4 mm</i> 18x7 cm   1,5 cm pack: 1</p>
	<p>30.42277 κόπτης για τρούφες μανιτάρια, σκληρό τυρί, σοκολάτα <i>truffles, mushrooms, parmesan, chocolate slicer</i> 22x8,5 cm pack: 1</p>
	<p>*25.40060 YC90006 βουρτσάκι για τρούφες μανιτάρια, λαχανικά ξύλινο με φυσική τρίχα <i>wooden mushroom brush, ideal for truffles mushrooms, new vegetables and potatoes natural bristles</i> 4 cm pack: 1</p>
	<p>*25.40059 YC90106 βουρτσάκι για τρούφες μανιτάρια, λαχανικά ξύλινο με φυσική τρίχα <i>wooden mushroom brush, ideal for truffles mushrooms, new vegetables and potatoes natural bristles</i> 12,5 cm pack: 1</p>



γουδί | *mortar*

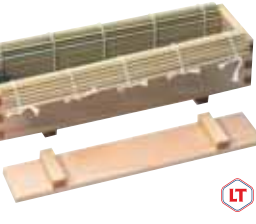

	<p>35.01073 γουδί από γρανίτη <i>Solid polished granite mortar and pestle with a non- scratch base.</i> 12 cm   6,5 cm pack: 1</p>
---	--

*oriental gadgets*

	<p>KitchenCraft bamboo steamer δίπυλο <i>oriental bamboo steamer two tier</i> 35.00042 20 cm pack: 1/6 35.01720 25 cm pack: 1/2</p>
	<p>35.00124 ξυλάκια μπαμπού σετ 10 τμχ. <i>oriental bamboo chopsticks pack of 10</i> 24 cm pack: 1</p>
	<p>35.03867 κουτάλα αράχνη μπαμπού <i>oriental bamboo skimmer</i> pack: 1</p>
	<p>25.40041 SUSH02 sushi κιτ κουτί με καπάκι από φυσικό ξύλο και mat από μπαμπού <i>sushi and makis making kit box and lid in natural wood, bamboo mat</i> 26x7,5 cm   5,5 cm pack: 1</p>
	<p>25.40042 SUSH03 sushi roller mat μπαμπού <i>sushi roller bamboo mat</i> 24x24 cm pack: 1</p>



φιάλες σάλτσας | *sauce bottles*

	30.40339 κίτρινη   <i>yellow</i> 20 cl pack: 1
	30.40340 κόκκινη   <i>red</i> 20 cl pack: 1
	30.40341 διάφανη   <i>transparent</i> 20 cl pack: 1
	30.40342 κίτρινη   <i>yellow</i> 35 cl pack: 1
	30.40343 κόκκινη   <i>red</i> 35 cl pack: 1
	30.40344 διάφανη   <i>transparent</i> 35 cl pack: 1
	30.40345 κίτρινη   <i>yellow</i> 70 cl pack: 1
	30.40346 κόκκινη   <i>red</i> 70 cl pack: 1
	30.40347 διάφανη   <i>transparent</i> 70 cl pack: 1

φιάλες σάλτσας | *sauce bottles*





	30.42165 διανεμητής λευκός <i>dispenser red</i> 2,5 l GN 1/6   20 cm pack: 1
	30.42164 διανεμητής κίτρινος <i>dispenser yellow</i> 2,5 l GN 1/6   20 cm pack: 1
	30.42163 διανεμητής κόκκινος <i>dispenser red</i> 2,5 l GN 1/6   20 cm pack: 1

φιάλες σάλτσας με βαλβίδα non-drip

*non-drip sauce bottles*

(Polyethylene - LD)



	46.05554 κίτρινη   <i>yellow</i> 35 cl pack: 16
	46.02554 κόκκινη   <i>red</i> 35 cl pack: 16
	46.00554 λευκή   <i>white</i> 35 cl pack: 16
	46.05555 κίτρινη   <i>yellow</i> 50 cl pack: 16
	46.02555 κόκκινη   <i>red</i> 50 cl pack: 16
	46.00555 λευκή   <i>white</i> 50 cl pack: 16
	46.05556 κίτρινη   <i>yellow</i> 75 cl pack: 16
	46.02556 κόκκινη   <i>red</i> 75 cl pack: 16
	46.00556 λευκή   <i>white</i> 75 cl pack: 16
	46.05557 κίτρινη   <i>yellow</i> 100 cl pack: 16
	46.02557 κόκκινη   <i>red</i> 100 cl pack: 16
	46.00557 λευκή   <i>white</i> 100 cl pack: 16

φιάλες σάλτσας | *sauce bottles*

	30.42226 φιάλη διάφανη, τοποθετείται και ανάποδα <i>squeeze dispenser clear</i> <i>can be placed upside down</i> 230 ml 5 cm   16 cm pack: 1
--	--

φιάλες σάλτσας | *sauce bottles*

	27.93226 σετ 4 φιάλες διακόσμησης <i>squeeze bottle, 4 pcs.</i> <i>with tight-screw and cap</i> 5 ml 3,5 cm   9,5 cm pack: 1
--	---





**30.40109**  
ηλεκτρονική ζυγαριά  
κουζίνας  
*digital large scale*  
100 kgr / (50 gr)  
30x25,5 cm | 4,2 cm  
pack: 1

HENDI



**63.10017** ζυγαριά κουζίνας LCD  
*kitchen scale LCD*  
8 kgr  
pack: 1

sammic

ψηφιακή ζυγαριά ακριβείας  
με χρονοδιακόπτη, 3 kgr  
με απόκλιση  $\pm 0,1$  gr, ενδείξεις σε gr, lb ή oz,  
εξ ολοκλήρου από μαύρο ABS,  
οθόνη LCD, αυτόματο απόβαρο, ένδειξη  
υπερφόρτωσης και χαμηλής ισχύος, χρο-  
νοδιακόπτης (μέγιστο 20 λεπτά)  
με 2 μπαταρίες λιθίου (δεν περιλαμβά-  
νονται)



ηλεκτρονική ζυγαριά κουζίνας, 5 kgr  
με απόκλιση  $\pm 1$  gr, ελάχιστη ζύγιση 20 gr  
ενδείξεις σε gr, Kgr ή lb  
με 2 μπαταρίες λιθίου  
*digital large scale*  
*weighs up to 5 Kgr with gradation of  $\pm 1$ g*  
*with a minimum of 20g, readout in g, kg, oz or*  
*lb/oz, powered by 2 lithium batteries*  
**30.40714** 20x15,1 cm | 1,1 cm  
pack: 1

HENDI



**30.42228** 13x19 cm | 2,5 cm  
pack: 1

*high precision scale with timer, 3 kgr*  
*weighs up to 3 Kgr with gradation of  $\pm 0,1$ g*  
*readout in g, lb or oz, made of black ABS*  
*backlit LCD, auto tare, overload and low power*  
*indication, timer (max 20 minutes)*  
*powered by 2AAA batteries (not included).*



ηλεκτρονική ζυγαριά  
με χρονοδιακόπτη, λειτουργεί  
με 2 μπαταρίες  
*digital scale, with integrated timer, powered*  
*by 9V alkaline battery, not included*  
5 kgr / (1 gr)  
**30.41405** 17x21,5 cm | 5,5 cm  
pack: 1

HENDI



**30.42229** 16x21 cm | 3 cm  
pack: 1

ψηφιακή ζυγαριά ακριβείας, 10 kgr  
με απόκλιση  $\pm 1$  gr, ενδείξεις σε gr, kgr, ml,  
lb ή oz, μαύρο ABS και τάσι από σατινέ  
ανοξείδωτο χάλυβα, αυτόματο απόβαρο,  
ένδειξη υπερφόρτωσης και χαμηλής  
ισχύος, δέχεται 3 μπαταρίες AAA (δεν  
περιλαμβάνονται) ή ενσωματωμένες  
επαναφορτιζόμενες λιθίου (450mAh)  
περιλαμβάνεται καλώδιο USB  
για επαναφόρτιση  
*high precision scale, 10 kgr*  
*weighs up to 10 Kgr with gradation of  $\pm 1$ g*  
*readout in g, kg, ml, lb or oz, made of black ABS*  
*with a satin stainless steel platform,*  
*clear backlit LCD display, auto power off, auto*  
*tare, overload and low power indication,*  
*powered by 3AAA batteries (not included), or*  
*build-in rechargeable lithium battery*  
*(450mAh), USB-cable included for recharging.*



ηλεκτρονική ζυγαριά ακριβείας 15 Kgr  
με απόκλιση  $\pm 1$  gr, ελάχιστη ζύγιση 2 gr  
ενδείξεις σε gr, με 2 μπαταρίες  
*digital scale, weighs up to 15 Kgr*  
*with gradation of  $\pm 1$ g with a min. of 2gr*  
*high precision strain gauge sensor, readout in*  
*grams, powered by 3AAA batteries*  
15 kgr / (1 gr)  
**30.41474** 26,6x26,9 cm | 3,4 cm  
pack: 1

HENDI



**25.00805**  
4887.00

μίνι ζυγαριά ακριβείας  
με καπάκι  
*mini precision balance*  
*with lid*  
11,5x6,4 cm  
(0,5 kg - 0,1 grs)  
pack: 1

χρονόμετρα | timers



χρονόμετρο 60 λεπτών  
με μαγνήτη και με κόκκινη ένδειξη  
υπολοιπούμενου χρόνου  
με ακρίβεια 1 λεπτού  
*analog kitchen timer 60 minutes*  
*accurate to 1 min, magnetic rear, red*  
*marking indicates remaining time*  
**30.40719** pack: 1

HENDI



ψηφιακό χρονόμετρο κουζίνας  
*digital kitchen timer*  
**30.40182** 6,5x7 cm  
pack: 1

HENDI



Θερμόμετρα | *thermometers*



θερμόμετρο infrared  
*infrared thermometer*  
-32° έως/to +300°C  
απόκλιση/accuracy: 1,5°C  
διαβάθμιση/gradation: 0,1°C  
λειτουργεί με μπαταρία 9V battery

30.40108 3,7x7x15 cm  
pack: 1



θερμόμετρο infrared με αισθητήρα  
*infrared thermometer with prob*  
-60° έως/to +350°C  
απόκλιση/accuracy: 1°C  
διαβάθμιση/gradation: 0,2°C  
μπαταρία | battery 2xAAA

30.41759 3,9x5,3x15,8 cm  
pack: 1



θερμόμετρο ακίδας  
*shockproof thermometer with probe*  
-50° έως/to +300°C  
απόκλιση/accuracy: 1°C  
διαβάθμιση/gradation: 0,1°C  
με st. steel ακίδα/probe: 21,3 cm  
αδιάβροχο, με θήκη & stand  
including protection case

30.40111 8,5x4,5x19,5 cm  
pack: 1



θερμόμετρο ακίδας  
*thermometer with probe*  
-50° έως/to +300°C  
απόκλιση/accuracy: 1°C  
διαβάθμιση/gradation: 0,1°C  
με st. steel ακίδα/ foldable robe: 11 cm

30.40536 15 cm  
pack: 1



θερμόμετρο ακίδας  
*fast response thermometer*  
-50° έως/to +350°C  
απόκλιση/accuracy: 0,8°C  
διαβάθμιση/gradation: 0,1°C  
με st. steel ακίδα/probe: 13 cm  
αδιάβροχο/waterproof

30.40720 2x4,2 cm | 20,4 cm  
pack: 1



θερμόμετρο τσέπης  
*pocket thermometer*  
st. steel, 0° έως/to +100°C

30.40055 4,5x14 cm  
pack: 1



αδιάβροχο θερμόμετρο με αισθητήρα  
και κάλυμμα  
*waterproof thermometer with prob*  
και κάλυμμα  
-50° έως/to +300°C  
απόκλιση/accuracy: 1°C  
διαβάθμιση/gradation: 0,1°C

30.41079 2,9x4,8x4 cm  
pack: 1



θερμόμετρο τσέπης με αισθητήρα  
και κάλυμμα  
*pocket thermometer with prob*  
και κάλυμμα  
-40° έως/to +200°C  
απόκλιση/accuracy: 2°C  
διαβάθμιση/gradation: 0,1°C

30.41824 15x2x1,5 cm  
pack: 1

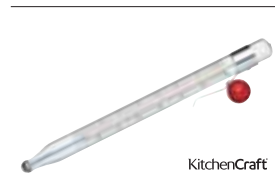

θερμόμετρο μαγειρέματος  
*cooking thermometer*  
50° έως/to 200°C

35.00285 pack: 1/6/72



θερμόμετρο μαγειρέματος  
*cooking thermometer*  
60° έως/to 204°C

35.00286 pack: 6/72



θερμόμετρο φούρνου, st. steel  
*oven thermometer*  
0° έως/to 300°C  
διαβάθμιση/gradation: 10°C

30.40716 6x7 cm  
pack: 1

Θερμόμετρα κρέατος | *steak thermometers*



σετ 4 θερμόμετρα steak mini, st. steel  
*set of 4 steak thermometers*  
 ενδείξεις/indication:  
 «rare - medium - well done»  
 30.40110 2,5x5 cm  
 pack: 1



35.00054 θερμόμετρο κρέατος  
*meat thermometer*  
 st. steel, έως/to 88°C  
 pack: 1/72



Θερμόμετρο/σπάτουλα | *thermometer spatula*



LT  
 θερμόμετρο/σπάτουλα  
 συμβατό με induction  
 παίρνει ενδείξεις κατά την ανάδευση  
*thermometer spatula compatible*  
*with induction, take measurements*  
*through insertion or whilst stirring*  
*(sauces, tempering chocolate, etc.)*  
 -50°C +300°C (0,1°C)  
 \*25.40038 st. steel/ABS/silicone  
 YC60804 pack: 1



Θερμόμετρο γάλακτος | *milk frothing thermometer*



θερμόμετρο γάλακτος με κλιπ και  
 πράσινη ένδειξη ιδανικής  
 θερμοκρασίας γάλακτος  
*milk frothing thermometer*  
*green marking indicates the ideal*  
*temperature*  
 st. steel, -10° έως/to +110°C  
 30.41218 pack: 1

Θερμόμετρα ψυγείου | *refrigerator thermometers*



HENDI  
 θερμόμετρο ψυγείου  
*refrigerator thermometer*  
 -40° έως/to +20°C  
 διαβάθμιση/gradation: 1°C  
 30.41760 12,3x3 cm  
 pack: 1



HENDI  
 θερμόμετρο ψυγείου  
*refrigerator thermometer*  
 -50° έως/to +25°C  
 διαβάθμιση/gradation: 2,5°C  
 30.40717 6x7 cm  
 pack: 1

Θερμόμετρο ζαχαροπλαστικής | *candy thermometer*



θερμόμετρο ζαχαροπλαστικής  
 (χωρίς υδράργυρο) με μεταλλικό  
 κάλυμμα αποστειρώνεται και  
 μπαίνει στο πλυντήριο  
*thermometer*  
*does not contain mercury*  
 80°C έως/to 200°C  
 \*25.00179 27,5 cm  
 4884.01 pack: 1



HENDI  
 θερμόμετρο ψυγείου/κατάψυξης  
*refrigerator thermometer*  
 -40° έως/to +40°C  
 30.40718 2,3x15x0,9 cm  
 pack: 1



HENDI  
 θερμόμετρο ψυγείου/κατάψυξης  
*refrigerator thermometer*  
 -50°C έως/to +50°C  
 30.41073 7,2x2,1 cm  
 pack: 1

Θερμόμετρο-χρονόμετρο | *thermometer/timer*



θερμόμετρο/χρονόμετρο ψηφιακό  
*roasting thermometer/timer*  
 0° έως/to 250°C  
 με st. steel ακίδα/probe: 21 cm  
 30.40181 6,5x7 cm  
 pack: 1





Γραδόμετρο | *syrup density meter*

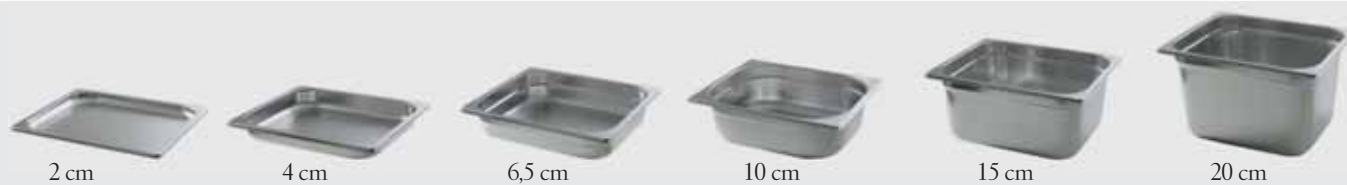

de Buyer  
 γραδόμετρο | *small syrup density meter*  
 διαβάθμιση/gradation:  
 1100-1400 g/ml -  
 15 έως/to 40° Baumé  
 \*25.00423 14 cm  
 4591.00N pack: 1



δοχεία φαγητού GN ανοξείδωτα | *inox gastronorm containers*

	60.46302 GN 1/1 - 2 cm pack: 6		60.46337 GN 2/1 - 2 cm pack: 10
	60.46360 GN 1/1 - 4 cm pack: 6		60.46359 GN 2/1 - 4 cm pack: 10
	60.46303 GN 1/1 - 6,5 cm pack: 10		60.46300 GN 2/1 - 6,5 cm pack: 10
	60.46304 GN 1/1 - 10 cm pack: 10		60.46338 GN 2/1 - 10 cm pack: 10
	60.46305 GN 1/1 - 15 cm pack: 10		60.46301 GN 2/1 - 15 cm pack: 6
	60.46306 GN 1/1 - 20 cm pack: 10		60.46307 GN 1/2 - 2 cm pack: 30
	60.46334 GN 2/3 - 6,5 cm pack: 10		60.46308 GN 1/2 - 6,5 cm pack: 20
	60.46340 GN 2/3 - 10 cm pack: 10		60.46309 GN 1/2 - 10 cm pack: 20
	60.46341 GN 2/3 - 15 cm pack: 10		60.46310 GN 1/2 - 15 cm pack: 10
	60.46342 GN 2/3 - 6,5 cm pack: 10		60.46311 GN 1/2 - 20 cm pack: 10

	60.46312	GN 1/3 - 6,5 cm pack: 20
	60.46313	GN 1/3 - 10 cm pack: 20
	60.46314	GN 1/3 - 15 cm pack: 20
	60.46315	GN 1/3 - 20 cm pack: 20

	60.46316	GN 1/4 - 6,5 cm pack: 20
	60.46317	GN 1/4 - 10 cm pack: 20
	60.46318	GN 1/4 - 15 cm pack: 20
	60.46319	GN 1/4 - 20 cm pack: 20

	60.46320	GN 1/6 - 6,5 cm pack: 20
	60.46321	GN 1/6 - 10 cm pack: 20
	60.46322	GN 1/6 - 15 cm pack: 20
	60.46323	GN 1/6 - 20 cm pack: 20

	60.46324	GN 1/9 - 6,5 cm pack: 20
	60.46325	GN 1/9 - 10 cm pack: 20
	60.46339	GN 1/9 - 15 cm pack: 20

	δοχεία GN διάτρητα   <i>perforated</i>	
	60.46332	GN 1/1 - 6,5 cm pack: 10
	60.46343	GN 1/1 - 10 cm pack: 10
	60.46344	GN 1/1 - 15 cm pack: 10
	60.46345	GN 1/1 - 20 cm pack: 10

	δοχεία GN διάτρητα   <i>perforated</i>	
	60.46335	GN 1/2 - 6,5 cm pack: 10
	60.46346	GN 1/2 - 10 cm pack: 10
	60.46347	GN 1/2 - 15 cm pack: 10
	60.46348	GN 1/2 - 20 cm pack: 10

	ράβδοι στήριξης   <i>adaptor bars</i>	
	30.40295	GN 1/1 - 52,5x2 cm pack: 1
	30.40294	GN 1/2 - 32,5x2 cm pack: 1

	60.46333	σάρα GN 1/1 pack: 10
	60.46349	σάρα GN 1/2 pack: 10
	60.46350	σάρα GN 1/3 pack: 10

	καπάκι για GN   <i>GN lids</i>	
	60.46326	G/N 1/1 pack: 10
	60.46358	G/N 2/1 pack: 10
	60.46336	G/N 2/3 pack: 10
	60.46327	G/N 1/2 pack: 10
	60.46328	G/N 1/3 pack: 20
	60.46329	G/N 1/4 pack: 20
	60.46330	G/N 1/6 pack: 40
	60.46331	G/N 1/9 pack: 40

	καπάκι sloted για GN   <i>GN lids sloted</i>	
	60.46351	G/N 1/1 pack: 10
	60.46357	G/N 2/3 pack: 20
	60.46352	G/N 1/2 pack: 20
	60.46353	G/N 1/3 pack: 20
	60.46354	G/N 1/4 pack: 20
	60.46355	G/N 1/6 pack: 40
	60.46356	G/N 1/9 pack: 40

διαστάσεις δοχείων GN  
*GN containers dimentions*

GN 2/1: 65x53 cm

GN 1/1: 53x32,5 cm

GN 1/2: 32,5x26,5 cm

GN 1/3: 32,5x17,6 cm

GN 1/4: 26,5x16,2 cm

GN 1/6: 17,3x16,2 cm

GN 1/3: 17,6x10,8 cm

GN 2/3: 35,4x32,5cm

GN 2/4: 53x16,2 cm

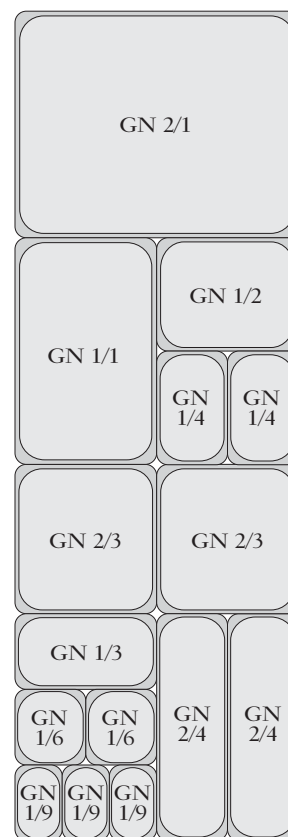



Κατασκευασμένα από υψηλής ποιότητας inox 18/10. Λείες άκρες, εύκολα στο πλύσιμο. Μπορούν να χρησιμοποιηθούν σε όλους τους φούρνους και κυκλοθερμικούς καθώς και σε ψυγεία και chafing dishes.

Made of high grade stainless steel 18/10. Very solid design. Smooth edges, easy to clean. Can be used in convection ovens, refrigerators, bain-marie systems and chafing dishes.

	<p>δοχεία GN 2/1 - containers GN 2/1 65x53 cm</p> <p>30.42053 GN 2/1 - 2 cm   5,5 lt pack: 1</p> <p>30.42052 GN 2/1 - 4 cm   11 lt pack: 1</p> <p>30.42051 GN 2/1 - 6,5 cm   19 lt pack: 1</p>		<p>δοχεία GN 1/2 - containers GN 1/2 32,5x26,5 cm</p> <p>*30.40747 GN 1/2 - 2 cm   1 lt pack: 1</p> <p>*30.40746 GN 1/2 - 4 cm   2 lt pack: 1</p>
	<p>30.42050 GN 2/1 - 10 cm   30 lt pack: 1</p> <p>30.42049 GN 2/1 - 15 cm   43 lt pack: 1</p> <p>30.42048 GN 2/1 - 20 cm   58 lt pack: 1</p> <p>δοχεία GN 1/1 - containers GN 1/1 53x32,5 cm</p> <p>30.40730 GN 1/1 - 2 cm   2,5 lt pack: 1</p> <p>*30.40729 GN 1/1 - 4 cm   5 lt pack: 1</p> <p>30.40728 GN 1/1 - 6,5 cm   9 lt pack: 1</p>		<p>30.40745 GN 1/2 - 6,5 cm   4 lt pack: 1</p> <p>30.40744 GN 1/2 - 10 cm   6,5 lt pack: 1</p> <p>30.40743 GN 1/2 - 15 cm   9,5 lt pack: 1</p> <p>*30.40742 GN 1/2 - 20 cm   12,5 lt pack: 1</p>
	<p>30.40727 GN 1/1 - 10 cm   14 lt pack: 1</p> <p>30.40726 GN 1/1 - 15 cm   21 lt pack: 1</p> <p>30.40725 GN 1/1 - 20 cm   28 lt pack: 1</p> <p>δοχεία GN 2/4 - containers GN 2/4 53x16,2 cm</p> <p>*30.40741 GN 2/4 - 2 cm   1,2 lt pack: 1</p> <p>*30.40740 GN 2/4 - 4 cm   2,5 lt pack: 1</p>		<p>δοχεία GN 1/3 - containers GN 1/3 32,5x17,6 cm</p> <p>*30.40753 GN 1/3 - 2 cm   0,8 lt pack: 1</p> <p>*30.40752 GN 1/3 - 4 cm   1,5 lt pack: 1</p> <p>30.40751 GN 1/3 - 6,5 cm   2,5 lt pack: 1</p> <p>30.40750 GN 1/3 - 10 cm   4 lt pack: 1</p> <p>30.40749 GN 1/3 - 15 cm   5,7 lt pack: 1</p> <p>*30.40748 GN 1/3 - 20 cm   7,8 lt pack: 1</p>
	<p>*30.40739 GN 2/4 - 6,5 cm   4 lt pack: 1</p> <p>*30.40738 GN 2/4 - 10 cm   5,8 lt pack: 1</p> <p>*30.40737 GN 2/4 - 15 cm   8,6 lt pack: 1</p> <p>δοχεία GN 2/3 - containers GN 2/3 35,4x32,5 cm</p> <p>*30.40736 GN 2/3 - 2 cm   1,5 lt pack: 1</p> <p>*30.40735 GN 2/3 - 4 cm   3 lt pack: 1</p>		<p>*30.40751 GN 1/3 - 6,5 cm   2,5 lt pack: 1</p> <p>30.40750 GN 1/3 - 10 cm   4 lt pack: 1</p> <p>30.40749 GN 1/3 - 15 cm   5,7 lt pack: 1</p> <p>*30.40748 GN 1/3 - 20 cm   7,8 lt pack: 1</p> <p>δοχεία GN 1/4 - containers GN 1/4 26,5x16,2 cm</p> <p>*30.40759 GN 1/4 - 2 cm   0,9 lt pack: 1</p> <p>*30.40758 GN 1/4 - 4 cm   1,7 lt pack: 1</p> <p>30.40757 GN 1/4 - 6,5 cm   1,8 lt pack: 1</p> <p>30.40756 GN 1/4 - 10 cm   2,8 lt pack: 1</p> <p>30.40755 GN 1/4 - 15 cm   4 lt pack: 1</p> <p>*30.40754 GN 1/4 - 20 cm   5,5 lt pack: 1</p>
	<p>*30.40733 GN 2/3 - 10 cm   9 lt pack: 1</p> <p>*30.40732 GN 2/3 - 15 cm   13 lt pack: 1</p> <p>*30.40731 GN 2/3 - 20 cm   18 lt pack: 1</p>		<p>δοχεία GN 1/9 - containers GN 1/9 17,6x10,8 cm</p> <p>*30.40765 GN 1/9 - 6,5 cm   0,6 lt pack: 1</p> <p>*30.40764 GN 1/9 - 10 cm   1 lt pack: 1</p>

δοχεία φαγητού GN ανοξείδωτα *st. steel 18/10 gastronorm containers «Profi line»*



δοχεία GN 1/6 - *containers GN 1/6*  
17,6x16,2 cm

- 30.40763 GN 1/6 - 6,5 cm | 1 lt  
pack: 1
- 30.40762 GN 1/6 - 10 cm | 1,6 lt  
pack: 1
- 30.40761 GN 1/6 - 15 cm | 2,4 lt  
pack: 1
- \*30.40760 GN 1/6 - 20 cm | 3,4 lt  
pack: 1



δοχεία GN 1/1 διάτρητα  
*perforated containers GN 1/1*  
53x32,5 cm

- 30.40771 GN 1/1 - 2 cm | 2,5 lt  
pack: 1
- \*30.40770 GN 1/1 - 4 cm | 5 lt  
pack: 1
- 30.40769 GN 1/1 - 6,5 cm | 9 lt  
pack: 1
- 30.40768 GN 1/1 - 10 cm | 14 lt  
pack: 1
- 30.40767 GN 1/1 - 15 cm | 21 lt  
pack: 1
- \*30.40766 GN 1/1 - 20 cm | 28 lt  
pack: 1



δοχεία GN 1/2 διάτρητα  
*perforated containers GN 1/2*  
32,5x26,5 cm

- \*30.40777 GN 1/2 - 4 cm | 2 lt  
pack: 1
- \*30.40776 GN 1/2 - 6,5 cm | 4 lt  
pack: 1
- 30.40775 GN 1/2 - 10 cm | 6,5 lt  
pack: 1



δοχεία GN 1/3 διάτρητα  
*perforated containers GN 1/3*  
32,5x17,6 cm

- \*30.40782 GN 1/3 - 4 cm | 1,5 lt  
pack: 1
- \*30.40781 GN 1/3 - 6,5 cm | 2,5 lt  
pack: 1
- \*30.40780 GN 1/3 - 10 cm | 4 lt  
pack: 1
- \*30.40779 GN 1/3 - 15 cm | 5,7 lt  
pack: 1
- \*30.40778 GN 1/3 - 20 cm | 7,8 lt  
pack: 1



δοχεία GN 2/3 διάτρητα  
*perforated containers GN 2/3*  
35,4x32,5 cm

- \*30.40774 GN 2/3 - 4 cm | 3 lt  
pack: 1
- \*30.40773 GN 2/3 - 6,5 cm | 5,5 lt  
pack: 1
- \*30.40772 GN 2/3 - 10 cm | 9 lt  
pack: 1



καπάκι για GN | *GN lids*

- 30.40783 GN 1/1  
pack: 1
- \*30.40784 GN 2/3  
pack: 1
- \*30.40785 GN 2/4  
pack: 1
- 30.40786 GN 1/2  
pack: 1
- 30.40787 GN 1/3  
pack: 1
- 30.40788 GN 1/4  
pack: 1
- 30.40789 GN 1/6  
pack: 1
- \*30.40790 GN 1/9  
pack: 1



καπάκια με τρύπα | *lids with spoon recess*



- \*30.40791 GN 1/1  
pack: 1
- \*30.40792 GN 2/3  
pack: 1
- \*30.40793 GN 1/2  
pack: 1
- \*30.40794 GN 1/3  
pack: 1
- \*30.40795 GN 1/4  
pack: 1
- \*30.40796 GN 1/6  
pack: 1



καπάκια με rim σιλικόνης | *lids with silicone rim*

*Με σιλικόνη κάτω από το χείλος.*

*Σφραγίζουν ερμητικά και διατηρούν τα φαγητά φρέσκα για περισσότερο χρόνο και δε χύνονται κατά τη μεταφορά. Ταιριάζουν μόνο στην σειρά «Profi line» και στα GN polycarbonate.*

*With silicone rim for airtight sealing.*

*Only suitable for «Profi-Line» and polycarbonate gastronorm containers. The airtight cover structure helps keep food fresh and avoid leaking during transportation.*

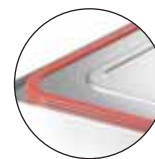

- \*30.40797 GN 1/1  
pack: 1
- \*30.40798 GN 2/3  
pack: 1
- \*30.40799 GN 1/2  
pack: 1
- \*30.40800 GN 1/3  
pack: 1
- \*30.40801 GN 1/4  
pack: 1
- \*30.40802 GN 1/6  
pack: 1



# CAMBRO®

## ...από την παραλαβή στο πιάτο



Όλη η διαδρομή των τροφίμων από τον χώρο παραλαβής, στους χώρους αποθήκευσης (ξηράς ή ψυχομένης), προετοιμασίας, παραγωγής/μαγειρικής και σερβιρίσματος των πελατών πρέπει να γίνεται ακολουθώντας διαδικασίες και χρησιμοποιώντας εργαλεία που βοηθούν και στοχεύουν στη διασφάλιση της υγιεινής των τροφίμων.

Στο κεφάλαιο αυτό θα βρείτε προϊόντα, εργαλεία, συσκευές, δοχεία κ.λπ. που χρησιμοποιούνται στα διάφορα στάδια της πορείας αυτής των τροφίμων και τα οποία εναρμονίζονται με τις αρχές του συστήματος HACCP, κατάλληλα δηλαδή για χρήση με τρόφιμα στους χώρους που προαναφέραμε και εξυπηρετούν τους στόχους σας, την ασφάλεια και υγιεινή των τροφίμων.

Ιδιαίτερα στο σημείο αυτό του κεφαλαίου «Παραλαβή και Αποθήκευση» παρουσιάζονται ως επί το πλείστον προϊόντα της αμερικάνικης εταιρείας CAMBRO που φέρουν όλες τις πιστοποιήσεις, τεχνογνωσία και χρήση εξαιρετικής ποιότητας πρώτων υλών και τελενταίας τεχνολογίας μηχανήματων.



Στον ίδιο χώρο χρησιμοποιούνται και άλλα προϊόντα που αναφέρονται σε κάποιο στάδιο της πορείας του τροφίμου. Θα τα βρείτε στον κατάλογο κυρίως σε διάφορα σημεία του κεφαλαίου κουζίνα όπως π.χ. θερμομέτρα. Για περαιτέρω επικοινωνήστε με τον πωλητή της περιοχής σας.



*From Dock to Dining plate. Food enters from the receiving dock and goes to dry and refrigerated areas, to walk in freezers areas, to prep areas, to production /cook's line, to serving stations to Dining and after to dish area. All this journey of food has to be monitored by appropriate procedures ,guidelines, using tools and gadgets that made for promoting the safeness and hygiene of food.*





«S-Series»

παλέτες παραλαβής - αποθήκευσης | *dunnage racks*



παλέτα διάτρητη | *slotted dunnage rack*

92.00103 DRS300  
53,3x76 cm | 30 cm (680 Kg)  
pack: 1

92.00104 DRS360  
53,3x91,5 cm | 30 cm (680 Kg)  
pack: 1

92.00105 DRS480  
53,3x122 cm | 30 cm (1360 Kg)  
pack: 1

92.00106 DRS600  
53,3x152,5 cm | 30 cm (1360 Kg)  
pack: 1

92.00107 DRLNK  
σύνδεσμος παλετών  
*camlink connector*  
pack: 6

- Διατηρούν ασφαλή τα προϊόντα σας 30,5cm από το δάπεδο σε καταψύξεις, ψυγεία, ξηρούς θαλάμους και κύριους παραλαβής.
- Μονοκόμιατη σταθερή καιαοκενή με δυνατά ανθεκτικά πόδια.
- Το ποθυπροπυλένιο υψηλής αντοχής και ποιότητας είναι ασφαλές στους -38°C και φυσικά δεν σκουριάζει, δεν διαβρύνεται και δεν κάμπιεται.
- Με οχιομές που βοηθούν την κυκλοφορία αέρα.
- Εύκοδα στο πύσιμο και στέγνωμα



- *Keep frozen, cold or dry inventory 30,5cm safely off the floor.*
- *One piece construction and sturdy legs provide strength and stability.*
- *Heavy duty polypropylene is safe to -38°C, and will not rust, corrode or bend.*
- *Choose slotted tops for maximum air circulation around perishable products.*
- *Solid tops catch spills for easy clean up.*



τρόλεϊ μεταφοράς «πλατφόρμες» | *platform trolley*



30.41075  
τρόλεϊ μεταφοράς  
*platform trolley*  
73x48 cm | 82,5 cm  
(150 Kg)  
pack: 1



\*30.70015 PFWS 8X5  
τρόλεϊ μεταφοράς |  
*platform trolley*  
90x60 cm | 90 cm  
(120 Kg)  
pack: 1



\*30.70016 PFWP 10X6  
τρόλεϊ μεταφοράς |  
*platform trolley*  
1098x698 cm | 94 cm  
(400 Kg)  
pack: 1





# «CamSelving»

-38°C - +88°C

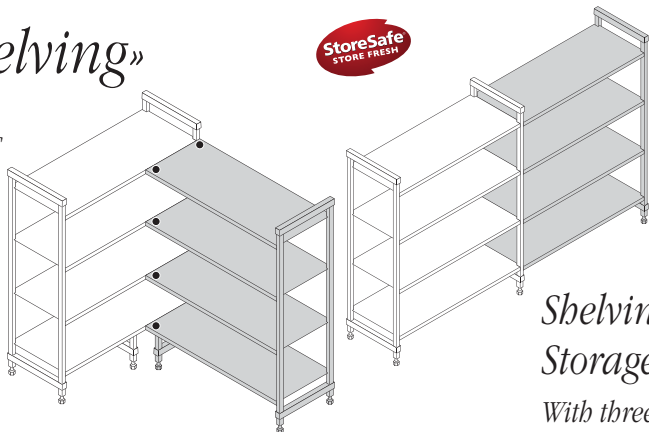

## Shelving for Life Storage redefined

With three distinct lines of Camshelving, all kitchens are created equal! Every foodservice operation deserves to be set up for maximized cost savings, space efficiency, sanitation, food safety and functionality no matter what the size or budget. Camshelving storage systems make it all possible, helping foodservice operators optimize organization, support food safety, improve labor savings, simplify inventory management, reduce food waste, and eliminate replacement costs.

### Key features of all camshelving series

- **Rust and Corrosion Free.** Backed by a lifetime warranty against rust and corrosion, Camshelving storage systems eliminate the inconvenience and costs associated with restoring or replacing degraded shelving. Only Cambro offers Shelving for Life.
- **Multi Environment Use.** Camshelving storage systems are designed to withstand all extreme storage applications and temperatures - impervious to moisture, chemicals, salt, food acids, and humidity. Camshelving systems can be installed anywhere and will never rust.
- **Maximized Space Utilization.** Components have been thoughtfully designed to maximize storage space, even in space-restricted areas.
- **Shared Post.** Space is money. Shelving units are designed to be interconnected, without compromising weightbearing capacity all while maximizing usable storage space.
- **Easy to Clean.** Cleaning shelving shouldn't be a major production. Whether daily or scheduled, cleaning can be done quickly and easily without interrupting storage space or normal, day-to-day operations.
- **Easy to Adjust.** Each shelf can be easily and independently adjusted to accommodate a variety of storage products and packages as product and storage needs change.
- **Corner Shelf Space.** Convert unusable space into continuous, easy-access storage areas using corner connectors.

Cambro offers three rust-free, non-corrosive, hygienic shelving systems that will hold up to the tough demands of commercial foodservice operations. Only Cambro offers Shelving for Life.

**Premium Plus.** High-volume foodservice operations with constant loading and off-loading of heavy products. Frequent and/or multiple daily deliveries. Posts and traverses are made from a steel core with smooth polypropylene exterior. Superior strength and durable enough to withstand the heaviest loading demands.

**Element series.** High-volume foodservice operations with constant loading and off-loading of medium to heavy products. Posts and traverses are made from a revolutionary composite material that is light in weight yet strong enough to withstand rigorous loading conditions.

## Συστήματα ραφιών για μια ζωή.

### Ο επαναπροσδιορισμός της αποθήκευσης.

Κάθε επιχείρηση πρέπει να επιτυγχάνει την μέγιστη εξοικονόμηση κόστους, την πλήρη εκμετάλλευση διαθέσιμου χώρου, την αποτελεσματικότερη υγιεινή και ασφάλεια των τροφίμων και την υψηλή λειτουργικότητα, ανεξάρτητα από το μέγεθος ή τον προϋπολογισμό της. Τα συστήματα αποθήκευσης ραφιών CamSelving κάνουν όλα αυτά πραγματικότητα βοηθώντας τους υπευθύνους σας να βελτιστοποιήσουν την οργάνωση, την ασφάλεια των τροφίμων, την εξοικονόμηση εργασιωτήτων, την αποδοτικότητα της απογράφης, την μείωση της σπάταλης τροφίμων και την εξάλειψη του κόστους αντικατάστασης.

### Βασικά χαρακτηριστικά όδων των συστημάτων ραφιών

- **Εγγυημένα για μια ζωή από σκουριά και διάβρωση.** HACCP
- **Χρήση σε κάθε περιβάλλον.** Ανταπεξέχονται σε κάθε ακραία κατάσταση αποθήκευσης, χημικά, άλατα, οξέα τροφίμων, υψηλή ή χαμηλή θερμοκρασία και είναι απρόσβητα στην υγρασία κ.λπ.
- **Μεγιστοποίηση της αποθηκευτικής δυνατότητας.**
- **Ο χώρος είναι χρήμα.** Συνδέονται μεταξύ τους με ένα αντί για δύο πλάινα χωρίσματα.
- **Εύκολος καθαρισμός.** Τα ράφια πρέπει να καθαρίζονται ευκολά χωρίς να διακόπεται η χρήση τους.
- **Εύκολη προσαρμογή ραφιών.** Εύκολη και γρήγορη αλλαγή θέσης ραφιού ή ραφιών για να μπορούν να εξυπηρετούν ποικιλία προϊόντων και συσκευασιών.
- **Ράφι γωνίας.** Μειωρέψει τον άχρηστο χώρο σε εύκολα προσβάσιμο αποθηκευτικό χώρο.

Η Cambro προσφέρει τρεις διαφορετικές σειρές ραφιών. Και οι τρεις δε σκουριάζουν και δεν διαβρώνονται. Είναι ιδανικές για υγιεινή φύλαξη τροφίμων σε ψυχρούς, θερμούς ή υγρούς χώρους και ικανές να εξυπηρετήσουν όλο το φάσμα της σύγχρονης επαγγελματικής εστίασης.

**Premium Plus.** Ιδανική να δεχτεί όγκους μεγάλου βάρους με συνεχή διακίνηση και ποδούς και ποικίλους ανεφοδιασμούς. Υλικό κατασκευής: εσωτερικά ατσάλι, εξωτερικά δείο πολυπροπυλένιο.

**Element series.** Εξυπηρετεί με άνεση βαριά προϊόντα και ποδάρπδες παραδόσεις την εβδομάδα. Υλικό κατασκευής: Επαναστατικό συνθετικό υλικό, ελαφρύ και ισομερώς ισχυρό να αντέχει στις δύσκολες συνθήκες φόρτωσης.

Οι δύο αυτές σειρές παραδίδονται καιότιν ειδικής μελέτης και παραγγελίας στο εξωτερικό.



HACCP



CdF



camguard  
ANTIBACTERIAL SHELF PLATES

ράφια αποθήκευσης



## «CamSelving» «Basic Plus»

Όταν ο προϋπολογισμός είναι σφιχτός και οι ανάγκες αποθήκευσης είναι διγότερο αυστηρές, αυτό δεν σημαίνει ότι τα ράφια που θα επιλέξουμε δεν θα πρέπει να είναι υψηλών προδιαγραφών και απόδοση αποθήκευσης υπό αμφισβήτηση.

Η σειρά Basic Plus είναι η δύση. Κατασκευασμένη από το ίδιο υψηλής απόδοσης, ισχυρό σύνθετο υλικό της Elements Series έχει τα ίδια χαρακτηριστικά σχεδιασμού με αυτήν.

Το βάρος είναι ελαφρύτερο άρα και το κόστος μικρότερο αλλά όμως η Basic Plus είναι αρκετά ισχυρή για να χειρίζεται σημαντικά βάρη και σημειώνει άριστες επιδόσεις στην υγιεινή χυρου και τροφίμων.

Η τοποθέτηση εύκομη. Πλήθώρα διαθέσιμων συνδυασμών μονάδων. Ράφια σε 7 διαφορετικά μήκη και 4 βάθη.

Υψηλή και αντοχή μονάδων.

3 σταθερές μονάδες: 1.63 - 1.83 - 2.14 m.

Ράφι 190 kg σύνολο 800 kg.

1 μετακινούμενη 1.79m (με ρόδες), 340 kg σύνολο.

Σχεδιασμός διυρεών. Καλέστε μας για να βρούμε την δύση στις ανάγκες σας και να σχεδιάσουμε το δικό σας σύστημα ραφιών στα δικά σας μέτρα και λειτουργικά και οικονομικά.

Just because the budget is tight and storage needs are less rigorous, it doesn't mean that shelving performance and storage efficiencies should be compromised.

Basics Plus Series is made from the same high performing, strong composite material as Elements Series and has the same design features. It's lighter in weight and less in cost but still strong enough to handle light to medium storage demands.





## δοχεία αποθήκευσης



# CAMBRO

Αντοχή σε θερμοκρασίες  
-40° έως +99°C.  
Ιδανικά για χρήση σε ψύξη  
και κατάψυξη.

Withstands temperatures  
from -40° to 99°C  
for use in coolers and freezers.

Συρόμενο καπάκι  
για εύκολη πρόσβαση.  
Sliding lid provides easy access.

Εύχρηστες λαβές.  
Molded-in handles  
ease carrying.



Λεία επιφάνεια εύκολη στο  
πλύσιμο, ανθεκτική σε  
λεκέδες και οσμές.  
Η καθαρότητά του επιτρέπει  
την εύκολη αναγνώριση  
του περιεχομένου.

Smooth surface is easy to clean.  
Stain and odor resistant.  
Crystal clear, durable Camwear  
allows for easy product  
identification.

Ανάγλυφος πάτος,  
ανθεκτικός  
στα γδαρσίματα.  
Texturing on bottom of  
boxes reduces scratching.

## «Cam Ware®»



Δοχεία αποθήκευσης τροφίμων polycarbonate & polypropylene για ασφαλή και υγιεινή φύλαξη τροφίμων, φρούτων, λαχανικών, ξηρών τροφών, νωπών ή κατεψυγμένων κρεάτων και ψαρικών. Εύκολη διαχείριση, κέρδος χρόνου, ελαττώνει τον κίνδυνο αλληλομολύνσεων.

Extend the freshness of ingredients and eliminate points of cross contamination by transferring product into food boxes at the receiving dock. A safe solution for storing bulk fruits and vegetables. Clear Camwear allows visibility for product identification. Snap tight Camwear covers or SlidingLids™, sold separately, won't come off during transportation.



## «Cam Ware®» polyethylene

-40° to +70°C



**92.00710** δοχείο αποθήκευσης PE  
18269P PE food storage box, 49,2 lt  
46x66 cm | 23 cm  
pack: 6



**92.00711** δοχείο αποθήκευσης PE  
182612P PE food storage box, 64,4 lt  
46x66 cm | 30 cm  
pack: 4



**92.00712** δοχείο αποθήκευσης PE  
182615P PE food storage box, 83,3 lt  
46x66 cm | 38 cm  
pack: 3



**92.00713** καπάκι PE flat  
1826CP PE flat lid  
45,7x66 cm  
pack: 6





«CamWare®» polycarbonate

polycarbonate -40° to +99°C

Τα δοχεία στραγγίσματος CamWare® σε συνδυασμό με ένα δοχείο αποθήκευσης CamWare® προσφέρει ποδδές και χρήσιμες υπηρεσίες ενισχύοντας την ποιότητα των τροφίμων και μειώνοντας τους κινδύνους διασταυρούμενης μόδυνσης.

Ιδανικά για αποστράγγιση φρούτων και λαχανικών, για κρέας που ξεπαγώνει ή την αποθήκευση θαλασσινών στον πάγο. Με γνώμονα τον όγκο των τροφίμων και περίπου τις ποσότητες υγρών που θα απεδευθερωθούν επιδέγγετε ένα από τα δύο δοχεία στραγγίσματος και ένα από τα ποδδά δοχεία αποθήκευσης. Τέδως, χρησιμοποιήστε το συρόμενο καπάκι που προσφέρει κέρδος χρόνου με το εύκοδο και γρήγορο άνοιγμα, ευκοδία ως προς την γωνιά πρόσβαση του περιεχομένου π.χ. όταν είναι κάτω από ράφι ή κάτω από ένα άλλο δοχείο.



Enhances food quality and reduces risk of cross contamination. Liquids and juices drain directly into food box for improved food safety. Ideal for draining fruits and vegetables, thawing meat or poultry, or storing seafood on ice.

	<p><b>92.00758</b> δοχείο σταγγίσματος PC 1826CLRCW για δοχεία 46x66x15 cm και βαθύτερα PC colander fits storage boxes 46x66x15 cm and deeper 12,7 cm βάθος   12,7 cm deep pack: 6</p>		<p><b>92.00759</b> δοχείο σταγγίσματος PC 18268CLRCW για δοχεία 46x66x23 cm και βαθύτερα PC colander fits storage boxes 46x66x23 cm and deeper 20 cm βάθος   20 cm deep pack: 4</p>	  	<p><b>92.00750</b> δοχείο αποθήκευσης PC 18263CW PC food storage box, 18,9 lt 46x66 cm   9 cm pack: 6</p> <p><b>92.00751</b> δοχείο αποθήκευσης PC 18266CW PC food storage box, 33,1 lt 46x66 cm   15 cm pack: 6</p> <p><b>92.00752</b> δοχείο αποθήκευσης PC 18269CW PC food storage box, 49,2 lt 46x66 cm   23 cm pack: 4</p> <p><b>92.00753</b> δοχείο αποθήκευσης PC 182612CW PC food storage box, 64,4 lt 46x66 cm   30 cm pack: 4</p> <p><b>92.00754</b> δοχείο αποθήκευσης PC 182615CW PC food storage box, 83,3 lt 46x66 cm   38 cm pack: 4</p> <p><b>92.00755</b> καπάκι PC flat 1826CCW PC flat lid 45,7x66 cm pack: 6</p> <p><b>92.00756</b> συρόμενο καπάκι PC 1826SCCW PC sliding lid 45,7x66 cm pack: 6</p> <p><b>92.00757</b> οχάρα PC 1826DSCW PC drain shelf 46x66 cm pack: 6</p>
--	--	--	---	--	--







«CamSquare®»  
polycarbonate



- Κέρδος χώρου μέχρι 33%.
- Διαυγή τοιχώματα σαν από κρύσταλλο
- Επιτρέπουν αναγνώριση και μέτρηση περιεχομένου.

- Maximize your storage area with CamSquare food storage containers.
- The square shape provides 33% better space usage than traditional round containers. Clear Camwear provides product visibility for at a glance inventory management. Seal covers feature an inner and outer seal for superior spill resistance, even during transport.

-40° to +99°C



**92.00714** δοχείο PC  
2SFSCW  
PC container  
1,9 lt  
18,5x18,5 cm | 10 cm  
pack: 6



**92.00715** δοχείο PC  
4SFSCW  
PC container  
3,8 lt  
18,5x18,5 cm | 18,7 cm  
pack: 6



**92.00716** δοχείο PC  
6SFSCW  
PC container  
5,7 lt  
21,5x21,5 cm | 18,5 cm  
pack: 6



**92.00717** δοχείο PC  
8SFSCW  
PC container  
7,6 lt  
21,5x21,5 cm | 23 cm  
pack: 6



**92.00718** δοχείο PC με χέρια  
12SFSCW  
PC container with handles  
11,4 lt  
25,6x31 cm | 21 cm  
pack: 6



**92.00719** δοχείο PC με χέρια  
18SFSCW  
PC container with handles  
17,2 lt  
25,6x31 cm | 32 cm  
pack: 6



**92.00720** δοχείο PC με χέρια  
22SFSCW  
PC container with handles  
20,8 lt  
25,6x31 cm | 40 cm  
pack: 6



**92.00700** καπάκι για δοχεία  
SFC2SCPP  
1,9 & 3,8 lt  
seal cover for 1,9 & 3,8 lt  
pack: 6



**92.00701** καπάκι για δοχεία  
SFC6SCPP  
5,7 & 7,6 lt  
seal cover for 5,7 & 7,6 lt  
pack: 6

**92.00702** καπάκι για δοχεία  
SFC12SCPP  
11,4, 17,2 & 20,8 lt  
seal cover for 11,4, 17,2 & 20,8 lt containers  
pack: 6





- Ημιδιαφανή τοιχώματα με υψηλή χημική αντίσταση.
- Επιτρέπουν αναγνώριση και μέτρηση του περιεχομένου με μια ματιά.
- *Translucent material provides some content visibility and high chemical resistance.*
- *Easy to read graduations are printed on the outside for at a glance inventory management.*



«CamSquare®»  
polypropylene

-40° to +70°C

	<p><b>92.00703</b> δοχείο PP - PP container 2SFSP 1,9 lt 18,5x18,5 cm   10 cm pack: 6</p>		<p><b>92.00721</b> καπάκι πράσινο για δοχεία 1,9 &amp; 3,8 lt cover «Kelly green» for 1,9 &amp; 3,8 lt containers SFC2 pack: 6</p>
	<p><b>92.00704</b> δοχείο PP - PP container 4SFSP 3,8 lt 18,5x18,5 cm   18,7 cm pack: 6</p>		<p><b>92.00722</b> καπάκι κόκκινο για δοχεία 5,7 &amp; 7,6 lt cover «winter rose» for 5,7 &amp; 7,6 lt containers SFC6 pack: 6</p>
	<p><b>92.00705</b> δοχείο PP - PP container 6SFSP 5,7 lt 21,5x21,5 cm   18,5 cm pack: 6</p>		<p><b>92.00723</b> καπάκι μπλε για δοχεία 11,4, 17,2 &amp; 20,8 lt cover «midnight blue» for 11,4, 17,2 &amp; 20,8 lt containers SFC12 pack: 6</p>
	<p><b>92.00706</b> δοχείο PP - PP container 8SFSP 7,6 lt 21,5x21,5 cm   23 cm pack: 6</p>		
	<p><b>92.00707</b> δοχείο PP με χέρια PP container with handles 12SFSP 11,4 lt 25,6x31 cm   21 cm pack: 6</p>		
	<p><b>92.00708</b> δοχείο PP με χέρια PP container with handles 18SFSP 17,2 lt 25,6x31 cm   32 cm pack: 6</p>		
	<p><b>92.00709</b> δοχείο PP με χέρια PP container with handles 22SFSP 20,8 lt 25,6x31 cm   40 cm pack: 6</p>		



Δοχεία στρογγυλά polycarbonate και polypropylene για ασφαλή και υγιεινή φύλαξη τροφίμων, φρούτων, λαχανικών, ξηρών τροφών, νωπών ή κατεψυγμένων κρεάτων ή ψαρικών. Το στρογγυλό τους σχήμα είναι καιάδδηδο για σούπες και σάλτσες. Εύκολη διαχείριση, κέρδος χρόνου, ελαττώνει τον κίνδυνο αλλοιομοδυνσεων.



Store ingredients or transport ready to serve or partially prepared foods. Clear Camwear allows for easy content identification at a glance. Reduces risk of contamination and enhances food safety. Round shape promotes proper air circulation, ideal for stirring soups and sauces.

polycarbonate «CamWare®»



-40° to +99°C



**92.00724** δοχείο PC με χέρια, 1,9 lt  
RFSCW2  
PC container with handles  
20,8 cm | 11,1 cm  
pack: 12



**92.00727** αεροστεγές PP καπάκι για δοχείο 1,9 lt  
RFS1SCPP  
seal PP cover for 1,9 lt container  
pack: 12



**92.00725** δοχείο PC με χέρια, 5,7 lt  
RFSCW6  
PC container with handles  
25,2 cm | 20,2 cm  
pack: 12



**92.00726** αεροστεγές PP καπάκι για δοχείο 5,7 lt  
RFS6SCPP190  
seal PP cover for 5,7 lt container  
pack: 12

polypropylene «CamWare®»

-40° to +70°C



**92.00729** δοχείο PP με χέρια  
RFS12PP  
PP container with handles  
11,4 lt  
37,8 cm | 21,3 cm  
pack: 12



**92.00730** δοχείο PP με χέρια  
RFS18PP  
PP container with handles  
17,2 lt  
37,8 cm | 30,5 cm  
pack: 12



**92.00731** δοχείο PP με χέρια  
RFS22PP  
PP container with handles  
20,8 lt  
37,8 cm | 38,1 cm  
pack: 12



**92.00728** αεροστεγές καπάκι για δοχεία 11,4, 17,2 & 20,8 lt  
RFS12SCPP  
seal covers for 11,4, 17,2 & 20,8 lt  
pack: 6



**92.00520** καπάκι θαμπό για δοχεία 11,4, 17,2 & 20,8 lt  
RFS12PP190  
covers for 11,4, 17,2 & 20,8 lt  
pack: 6





Το δοχείο που πάει παντού. Από την προετοιμασία του φαγητού, στο ψυγείο, στον φούρνο, στην θερμοράπεζα. Η σειρά δοχείων H-Pan είναι βασισμένη στις προδιαγραφές GN. Σε αντίθεση με τα μεταλλικά δοχεία τα H-Pans είναι καταλληλά για θέρμανση και διατήρηση. Με ανοχή μέχρι +192°C αντέχει περισσότερο από τα πλαστικά GN οπότε είναι ιδανικό για τρόχει με θέρμανση, ζεστούς μπουφές, chafers και διατήρηση στον ατμό.

Reduce handling and save expense with one pan that can go from prep to cooler to oven to steam table. H-Pans are designed to Gastronorm GN specifications. Unlike metal pans, H-Pans are safe for use in heating and holding applications. Ideal for heated carts, steam tables and chafing dishes. H-Pans have both standard and metric graduation markings to promote easy inventory management.

«High Heat H-Pans»

δοχεία GN  
GN food pans



	<p><b>92.00902</b> GN 1/2   6,5 cm (3,3 lt) 22HP150 pack: 6</p>		<p><b>92.00909</b> GN 1/4   10 cm (2,5 lt) 44HP150 pack: 6</p>
	<p><b>92.00903</b> GN 1/2   10 cm (5,9 lt) 24HP150 pack: 6</p>		<p><b>92.00910</b> καπάκι με λαβή cover with handle 16,2x26,5 cm pack: 6</p>
	<p><b>92.00918</b> σχάρα   drain shelf 20HPD150 pack: 6</p>		<p><b>92.00911</b> GN 1/6   6,5 cm (1 lt) 62HP150 pack: 6</p>
	<p><b>92.00904</b> καπάκι με λαβή cover with handle 26,5x32,5 cm pack: 6</p>		<p><b>92.00912</b> GN 1/6   10 cm (1,5 lt) 64HP150 pack: 6</p>
	<p><b>92.00905</b> GN 1/3   6,5 cm (2,4 lt) 32HP150 pack: 6</p>		<p><b>92.00913</b> GN 1/6   15 cm (2,2 lt) 66HP150 pack: 6</p>
	<p><b>92.00906</b> GN 1/3   10 cm (3,6 lt) 34HP150 pack: 6</p>		<p><b>92.00920</b> σχάρα   drain shelf 60HPD150 pack: 6</p>
	<p><b>92.00907</b> GN 1/3   15 cm (5,3 lt) 36HP150 pack: 6</p>		<p><b>92.00914</b> καπάκι με λαβή cover with handle 16,2x17,6 cm pack: 6</p>
	<p><b>92.00919</b> σχάρα   drain shelf 30HPD150 pack: 6</p>		<p><b>92.00915</b> GN 1/9   6,5 cm (0,57 lt) 92HP150 pack: 6</p>
	<p><b>92.00908</b> καπάκι με λαβή   cover with handle 17,6x32,5 cm pack: 6</p>		<p><b>92.00916</b> GN 1/9   10 cm (0,85 lt) 94HP150 pack: 6</p>
		<p><b>92.00917</b> καπάκι   flat cover 90HPC150 pack: 6</p>	
		<p><b>92.00900</b> δοχείο με μία λαβή pan with single handle GN 1/3   6,5 cm (2,4 lt) pack: 6</p>	
		<p><b>92.00901</b> δοχείο με δύο λαβές pan with two handles GN 1/3   6,5 cm (2,4 lt) pack: 6</p>	



«CamWare®» GN polycarbonate

Υψηλότερης ποιότητας πρώτη ύλη polycarbonate και αντοχός έλεγχος πάχους.



Camwear food pans are made from durable Camwear that will not crack, bend or dent.

-40° to +99°C



	<b>92.00403</b> GN 1/1   6,5 cm (8,5 lt) 12CW pack: 6		<b>92.00411</b> GN 1/3   6,5 cm (2,4 lt) 32CW pack: 6
	<b>92.00400</b> GN 1/1   10 cm (13 lt) 14CW pack: 6		<b>92.00408</b> GN 1/3   10 cm (3,6 lt) 34CW pack: 6
	<b>92.00401</b> GN 1/1   15 cm (19,5 lt) 16CW pack: 6		<b>92.00409</b> GN 1/3   15 cm (5,3 lt) 36CW pack: 6
	<b>92.00402</b> GN 1/1   20 cm (25,6 lt) 18CW pack: 6		<b>92.00410</b> GN 1/3   20 cm (6,9 lt) 38CW pack: 6
	<b>92.00427</b> σχάρα PC   drain shelf PC 10CWD pack: 6		<b>92.00429</b> σχάρα PC   drain shelf PC 30CWD pack: 6
	<b>92.00424</b> καπάκι PC με λαβή 10CWCH135 cover with handle 32,5x53 cm pack: 6		<b>92.00425</b> καπάκι PC με λαβή 30CWCH135 cover with handle 17,6x32,5 cm pack: 6
	<b>92.00435</b> καπάκι εύκαμπο PP 10PPCWSCI90 seal PP cover 32,5x53 cm pack: 6		<b>92.00437</b> καπάκι PP εύκαμπο 30PPCWSCI90 seal PP cover 17,6x32,5 cm pack: 6
	<b>92.00421</b> καπάκι ασφαλείας 10CWGL135 GripLid 32,5x53 cm pack: 6		
	<b>92.00407</b> GN 1/2   6,5 cm (3,9 lt) 22CW pack: 6		<b>92.00414</b> GN 1/4   6,5 cm (1,7 lt) 42CW pack: 6
	<b>92.00404</b> GN 1/2   10 cm (5,9 lt) 24CW pack: 6		<b>92.00412</b> GN 1/4   10 cm (2,5 lt) 44CW pack: 6
	<b>92.00405</b> GN 1/2   15 cm (8,9 lt) 26CW pack: 6		<b>92.00413</b> GN 1/4   15 cm (3,7 lt) 46CW pack: 6
	<b>92.00406</b> GN 1/2   20 cm (11,7 lt) 28CW pack: 6		<b>92.00430</b> σχάρα PC   drain shelf PC 40CWD pack: 6
	<b>92.00428</b> σχάρα PC   drain shelf PC 20CWD pack: 6		<b>92.00422</b> καπάκι με λαβή 40CWCH135 cover with handle 16,2x26,5 cm pack: 6
	<b>92.00434</b> καπάκι PC με λαβή 20CWCH135 cover with handle 26,5x32,5 cm pack: 6		<b>92.00438</b> καπάκι PP εύκαμπο 40PPCWSCI90 seal PP cover 16,2x26,5 cm pack: 6
	<b>92.00436</b> καπάκι PP εύκαμπο 20PPCWSCI90 seal PP cover 26,5x32,5 cm pack: 6		



- 92.00417 GN 1/6 | 6,5 cm (1 lt)  
62CW pack: 6
- 92.00415 GN 1/6 | 10 cm (1,5 lt)  
64CW pack: 6
- 92.00416 GN 1/6 | 15 cm (2,2 lt)  
66CW pack: 6
- 92.00431 σχάρα PC | *drain shelf PC*  
60CWD pack: 6
- 92.00426 καπάκι με λαβή  
60CWC135 *cover with handle*  
16,2x17,6 cm  
pack: 6
- 92.00439 καπάκι PP εύκαμπο  
60PPCWSC190 *seal PP cover*  
16,2x17,6 cm  
pack: 6



- 92.00420 GN 1/9 | 6,5 cm (0,57 lt)  
92CW pack: 6
- 92.00418 GN 1/9 | 10 cm (0,85 lt)  
94CW pack: 6
- 92.00419 GN 1/9 | 15 cm (1,4 lt)  
96PCW pack: 6
- 92.00432 σχάρα PC | *drain shelf PC*  
90CWD pack: 6
- 92.00423 καπάκι επίπεδο | *flat cover*  
90CWC135 16,2x26,5 cm  
pack: 6
- 92.00440 καπάκι PP εύκαμπο  
90PPCWSC190 *seal PP cover*  
16,2x17,6 cm  
pack: 6

Διατίθενται κατόπιν ειδικής παραγγελίας καπάκια με εγκοπή *notched* (για κουτάδα) και καπάκια με παράθυρο *fliplid* και καπάκι με παράθυρο και εγκοπή. | *Optional lids. Notched, fliplid and notched fliplid.*

*FlipLid®*

*Notched FlipLid®*



καπάκι με λαβή  
*cover with handle*



καπάκι ασφαλείας  
*GripLid®*



καπάκι PP  
εύκαμπο  
*seal PP cover*



καπάκι επίπεδο  
*flat cover*





«CamWare®» GN  
polypropylene



-40° to +70°C



92.00500 GN 1/1 | 6,5 cm (8,5 lt)  
12PP pack: 6



92.00501 GN 1/1 | 10 cm (13 lt)  
14PP pack: 6



92.00502 GN 1/1 | 15 cm (19,5 lt)  
16PP pack: 6



92.00503 GN 1/1 | 20 cm (25,6 lt)  
18PP pack: 6



92.00504 GN 1/2 | 6,5 cm (3 lt)  
22PP pack: 6



92.00505 GN 1/2 | 10 cm (5,9 lt)  
24PP pack: 6



92.00506 GN 1/2 | 15 cm (8,9 lt)  
26PP pack: 6



92.00507 GN 1/2 | 20 cm (11,7 lt)  
28PP pack: 6



92.00436 καπάκι PP εύκαμπτο  
20PPCWSCI90 seal PP cover  
26,5x32,5 cm cm  
pack: 6

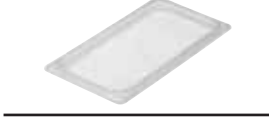

92.00508 GN 1/3 | 6,5 cm (2,4 lt)  
32PP pack: 6

92.00509 GN 1/3 | 10 cm (3,6 lt)  
34PP pack: 6

92.00510 GN 1/3 | 15 cm (5,3 lt)  
36PP pack: 6

92.00437 καπάκι PP εύκαμπτο  
30PPCWSCI90 seal PP cover  
17,6x32,5 cm  
pack: 6



92.00511 GN 1/4 | 6,5 cm (1,7 lt)  
42PP pack: 6



92.00512 GN 1/4 | 10 cm (2,5 lt)  
44PP pack: 6



92.00513 GN 1/4 | 15 cm (3,7 lt)  
46PP pack: 6



92.00438 καπάκι PP εύκαμπτο  
40PPCWSCI90 seal PP cover  
16,2x26,5 cm  
pack: 6



92.00514 GN 1/6 | 6,5 cm (1 lt)  
62PP pack: 6



92.00515 GN 1/6 | 10 cm (1,5 lt)  
64PP pack: 6



92.00516 GN 1/6 | 15 cm (2,2 lt)  
66PP pack: 6



92.00439 καπάκι PP εύκαμπτο  
60PPCWSCI90 seal PP cover  
16,2x17,6 cm  
pack: 6



92.00517 GN 1/9 | 6,5 cm (0,57 lt)  
92PP pack: 6

92.00518 GN 1/9 | 10 cm (0,85 lt)  
94PP pack: 6

92.00440 καπάκι PP εύκαμπτο  
90PPCWSCI90 seal PP cover  
16,2x17,6 cm  
pack: 6



τρόλει αποθήκευσης τροφίμων  
*ingredient bins with weels*

- Αποθηκεύουν χύμα ξηρά τρόφιμα, (αλεύρι, σιτηρά κ.ά.)
- Το διάφανο επικλινές στρόμενο καπάκι ανοιγοκλείνει ποδη εύκοδα. Επιτρέπει την άμεση αναγνώρισης του περιεχομένου και τη δειπυργική πρόσβαση στο εσωτερικό του.
- Ο κάδος είναι κατασκευασμένος από FDA-εγκεκριμένο υλικό για επαφή με τρόφιμα, και έτσι δεν χρειάζεται εσωτερικό δοχείο.
- Σχεδιασμένα για να χωρούν κάτω από πάγκους εργασίας.
- Πλένονται εύκοδα και αποτεδευματικά δεν επιτρέπουν τις διαστανρούμενες επιμολύνσεις.
- Το «CC32» χρησιμοποιείται και για το πλύσιμο και το σιράγγισμα λαχανικών, κ.ά.



- Store bulk dry ingredients such as flour and grain.
- Hygienic clear sliding lid reduces handling and allows for quick content identification.
- Bin made of FDA-accepted material so no liners are needed.
- Prevents cross contamination and minimizes unnecessary handling.
- Designed to fit under standard work tables.
- Use «CC32» to wash and rinse produce for easy and safe prep.



	<b>92.00650</b> IBS20 τρόλει αποθήκευσης τροφίμων με ρόδες ingredient bins with weels 33x75 cm   71 cm (81 lt) pack: 1
	<b>92.00651</b> IBS27 τρόλει αποθήκευσης τροφίμων με ρόδες ingredient bins with weels 42x75 cm   71 cm (102 lt) pack: 1
	<b>92.00652</b> IBS37 τρόλει αποθήκευσης τροφίμων με ρόδες ingredient bins with weels 55x75 cm   71 cm (140 lt) pack: 1
	<b>92.00653</b> CC32 τρόλει αποθήκευσης τροφίμων με ρόδες και βρύση ingredient bins with weels 56x61 cm   58,5 cm (121 lt) pack: 1

για σέσουλες ανατρέξε

σελίδες **398**  
KOYZINA

-40° to +70°C κουβάς αποθήκευσης | *pail with bail*

	<b>92.00519</b> PWB22148 κουβάς PE για προετοιμασία, αποθήκευση, μεταφορά και τροφίμων <i>multi-purpose pail, ideal for mixing, storing and transporting</i> pack: 6
	<b>92.00521</b> RFSC12 καπάκι κουβά cover for pail pack: 6





## τρόχει κουζίνας

**HENDI**



τρόχει πύργος inox  
με ασφάλεια και στις 2 πλευρές  
με 4 ρόδες (οι δύο με φρένο)

*clearing trolley s.s., tray locks on either side  
fitted with four castors of which  
two have brakes*

30.40188 για 15 δοχεία GN 1/1  
15 GN 1/1 trays  
61,5x45 cm | 169,5 cm  
pack: 1

**HENDI**



τρόχει για 7 δοχεία GN 1/1  
με επιφάνεια εργασίας  
με ασφάλεια και στις 2 πλευρές  
με 4 ρόδες (οι δύο με φρένο)

*clearing trolley for 7 GN 1/1 trays  
with working surface  
tray locks on either side  
fitted with four castors of which  
two have brakes*

30.40187 38x55 cm | 92,5 cm  
pack: 1

**HENDI**

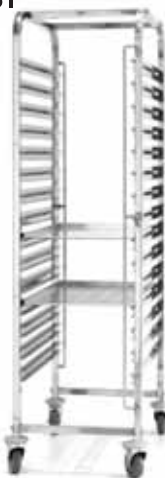

τρόχει πύργος inox  
με ασφάλεια και στις 2 πλευρές  
με 4 ρόδες (οι δύο με φρένο)

*clearing trolley s.s., tray locks on either side  
fitted with four castors of which  
two have brakes*

30.40186 για 15 δίσκους 60x40 cm  
15 trays 60x40 cm  
69x51,5 cm | 169,5 cm  
pack: 1

**HENDI**

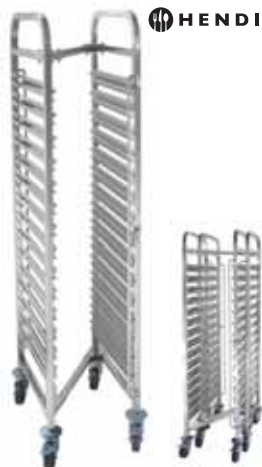

τρόχει πύργος πτυσσόμενο inox  
(για εξοικονόμηση χώρου κατά  
την αποθήκευσή τους)  
με ασφάλεια και στις 2 πλευρές  
με 4 ρόδες (οι δύο με φρένο)

*clearing trolley compact storage s.s.,  
in order to save space during storage  
trolleys can be pushed into one another;  
tray locks on either side  
fitted with four castors of which  
two have brakes*

30.40724 για 15 δίσκους GN 1/1  
15 GN 1/1 trays  
38x55 cm | 170 cm  
pack: 1



**HENDI**



τρόχει από ανοξείδωτο ατσάλι  
ράφια με ηχομονωτικό υλικό  
μέγιστο φορτίο 50 kg ανά ράφι  
με 4 ρόδες castor, οι 2 με φρένο,  
με προστατευτικά γωνιών

*trolley, made of stainless steel,  
shelves with sound insulation material  
maximum load per tray 50 kg  
with 4 castors, of which 2 with brakes,  
fitted with corner protection*

30.40721 με 2 ράφια | 2 shelves  
91x59 cm | 95 cm  
pack: 1

30.40722 με 3 ράφια | 3 shelves  
91x59 cm | 95 cm  
pack: 1

30.42260 με 4 ράφια | 4 shelves  
91x59 cm | 126 cm  
pack: 1



**HENDI**

τρόχει βαρέως τύπου inox με 3 ράφια  
με συγκόλληση, 80 kg ανά ράφι  
με 4 ρόδες castor, οι 2 με φρένο,  
*heavy duty trolley, s.s., welded for extra  
strength, 3 shelves (per tray 80 kg)  
with 4 castors, of which 2 with brakes,*

30.41917 80x50 cm | 85 cm  
pack: 1



**HENDI**

ραφιέρα αποθήκευσης βαρέως τύπου  
από επichρωμωμένο σίδηρο  
με ρυθμιζόμενα ράφια,

*heavy duty storage rack  
chrome-plated iron, adjustable shelves*

30.41915 με 4 ράφια | 4 shelves  
91x45,5 cm | 183 cm  
pack: 1

30.40099 με 5 ράφια | 5 shelves  
91x45,5 cm | 183 cm  
pack: 1

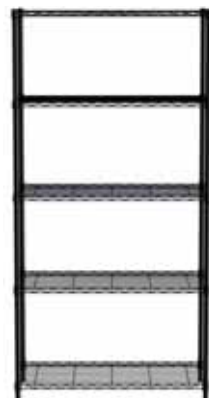

ραφιέρα αποθήκευσης βαρέως τύπου  
από επichρωμωμένο σίδηρο  
με ρυθμιζόμενα ράφια,

*heavy duty storage rack  
chrome-plated iron, adjustable shelves*

30.42261 με 5 ράφια μαύρη  
5 shelves, black  
91x45,5 cm | 183 cm  
pack: 1



## «Servistar 80»

**B.PRO**  
CATERING SOLUTIONS

- Το τρόδεϊ που σεβεται την επένδυσή σας. Είναι γρήγορο, αθόρυβο, σταθερό, πιάνει λίγο χώρο και το σπουδαιότερο ακόμα και σε κακό πάτωμα δεν του πέφτει πιάτο.
- Γερή κατασκευή από εξαιρετικό inox, βραχίονες με ελαστική επικάλυψη που συγκρατούν τα πιάτα πάντα στη θέση τους, μια πραγματικά έξυπνη ιδέα σε άψογη εκτέλεση.
- Μοναδικό κράτημα πιάτων. Το σχέδιο του βραχίονα που συγκρατεί το πιάτο μιμείται το ανθρώπινο χέρι. Το πιάτο κάθεται στη ανηφοδοθητική μαλακή ελαστική του θέση σαν αναμεσά σε δυο δάχτυλα, δείκτη και αντίχειρα. Η μετακίνηση του δεν προκαλεί κανένα θόρυβο.
- Κατασκευάζεται στην Γερμανία.
- Διατίθεται και τρόδεϊ 120 πιάτων.

\*30.70021 SERVISTAR80  
τρόδεϊ πιάτων «Servistar 80»  
με συνθετικές ρόδες  
65,3x66,3 cm | 185,6 cm  
pack: 1



- The SERVISTAR is perfect for handling prepared food in extremely tight spaces.
- The unique, innovative plate holders. The design is based on the example of the human hand - strong yet gentle at the same time. The small extra thumb gives the plates additional stability and provides ideal balance in any position. The plates rest on the plate holders in a soft and non-slip position due to the fine elastic soft-grip surface - no clattering, no clinking, no trouble.
- Create space in the kitchen.
- The innovative Blanco Servistar plate stacking system provides space for gastronomic creativity, effective working and a relaxed path from the chef to the guest. With its clever plate holder has a gentle and secure grip on your porcelain under any conditions. The Servistar can be loaded easily and plates can be removed quickly. With their elegant design, all of the models even look good in the front area.



- Φτιαγμένο από inox υψηλής ποιότητας με 2 polycarbonate καπάκια.
- Στατικά θερμαινόμενο +30 έως +110°C. Προστασία IP X5.
- Δέχεται 160 περίπου πιάτα - στρογγυλά 18-33cm ή τετράγωνα 28x28 cm.
- Διατίθενται τρόδεϊ για μικρότερα πιάτα και για μπωλ.

Θερμαινόμενο τρόδεϊ πιάτων  
plate dispenser

**B.PRO**  
CATERING SOLUTIONS

- Made of corrosion-resistant stainless steel.
- Statically heatable, temperatures can be regulated from +30 to +110°C. Protection type IP X5
- Approx. 160 plates - round dia. 18-33 cm, rectangular 28x28 cm

\*30.70020 TS-H2 18-33  
107x52 cm | 103 cm  
1.200 W - 220-240V  
pack: 1





«Cam GoBox» ελαφριά ισοθερμικά δοχεία EPP (διογκωμένο PP)  
insulated lightweight carriers (expanded PP)

- Τα δοχεία που υπόσχονται ποδόδα.
- Εύκολα στην μεταχείριση και στη μεταφορά τους. Στέρεα, ανθεκτικά και ταυτόχρονα ποδύ εδάφρια με ψηνάδιατη δυνατότητα διατήρησης της ιδανικής θερμοκρασίας. Οικονομικά, καιάάδηδα για catering.
- Η πόδουσα σε οχήματα και μεγέθη σειρά «Cam GoBox», σε συνδυασμό με το απίστευτα μικρό βάρος τους, τη μεγάλη ανοιχή στην απαιητική χρήση, στην επαφή με χημικά, στις ψηνάδες και χαμηνάδες θερμοκρασίες και το εύκολο γέμισμα από επάνω ή από εμπρός, τα καθιστούν απαραίητια σε μικρές ή μεγάλες επιχειρήσεις.

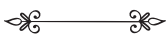

- Cambro's latest line of insulated transporters are ideal for caterers and foodservice operators looking for an ultra-lightweight transporter that offers superior temperature retention to protect food safety and excellent durability to withstand heavy commercial use, all at a budgetfriendly price. Just take them and go!
- Thermal Insulation, holds hot or cold food for many hours. Lightweight, made of EPP (Expanded Polypropylene) an eco-friendly, high-performance foam material. Great Structural Strength, capable of handling significant loads while maintaining its shape and form. Chemically Inert, unaffected by oil, grease, and most chemicals. Dishwasher safe. 100% Recyclable.



διατήρηση ζεστών

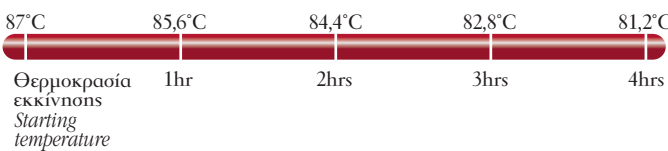

διατήρηση κρύων

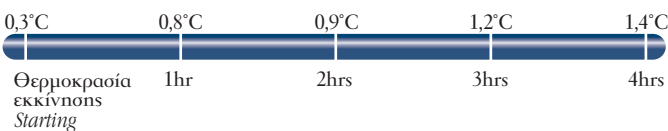



**ΕΡΓΟΝΟΜΙΚΕΣ ΛΑΒΕΣ**



Οι εργονομικές λαβές επιτρέπουν την εύκοδη και ασφαλή μετακίνηση του «Cam GoBox».

**ERGONOMIC HANDLES**  
Comfortable handles allow easy and safe lifting of the Cam GoBox.

**ΣΤΟΙΒΑΓΜΑ**



Τα «Cam GoBox» στοιβάζονται μεταξύ τους αλλά και με τα ανταγωνιστικά.

**STACKABILITY**  
Cam GoBoxes inter-stack and also stack with major competitive brands.



**ΓΡΗΓΟΡΗ ΑΝΑΓΝΩΡΙΣΗ**

Με την τοποθέτηση της πλαστικής ετικέτας στην ενσωματωμένη θήκη ετικέτας, έχετε εύκοδη αναγνώριση του περιεχομένου. Οι ετικέτες χρησιμοποιούνται σε όλα τα «Cam GoBox» (στα EPP300 και EPP400 περιλαμβάνονται).

**EASY IDENTIFICATION**  
A built-in label area keeps plastic menu tags (included for EPP300 and EPP400) in place for easy content identification or routing. StoreSafe Labels can also be used with Cam GoBoxes.

**ΕΥΚΟΛΟ ΓΕΜΙΣΜΑ ΚΑΙ ΑΔΕΙΑΣΜΑ**



Οι έξυπνα σχεδιασμένες εσωτερικές εσοχές επιτρέπουν την εύκοδη πρόσβαση.

**EASY LOADING AND UNLOADING**  
Interior wall recesses make loading and unloading easy for both GN 1/1 as well as 1/2 pans.

**4-ΠΛΕΥΡΟΣ ΧΕΙΡΙΣΜΟΣ**



Ο έξυπνος σχεδιασμός του πάνω μέρους των EPP300 και EPP400 επιτρέπει το εύκοδο σήκωμα και τη γρήγορη μεταφορά τους.

**4-SIDED HANDLING**  
Thoughtfully designed built-in handles along the top of front loader units allow them to be easily carried from all four sides.

**ΕΥΚΟΛΟ ΑΝΟΙΓΜΑ ΚΑΙ ΚΛΕΙΣΙΜΟ**



Οι δοξές άκρες της πόρτας επιτρέπουν το εύκοδο κλείσιμο και κλείδωμα.

**GENTLE OPEN AND CLOSE**  
Beveled door edges ensure door can be easily closed and latched.

**«CAMBRO SOLUTION»**



Δοχεία GN, πλάκες θέρμανσης ή ψύξης κ.ά. για να επιωχάνετε την απόδοση ασφάλεια των τροφίμων.

**Cambro GN Food Pan and Seal Cover for the ultimate food safety solution. Cambro GN pans protect food and carrier to support HACCP compliance.**



**ΑΝΕΤΗ ΠΡΟΣΒΑΣΗ 270°**

Οι ανθεκτικοί μεντεσέδες και τα κλείστρα επιτρέπουν στην πόρτα για να ανοίγει κατά 270° και να παραμείνει ανοιχτή με ασφάλεια διευκολύνοντας την τοποθέτηση των δοχείων. Τα κλείστρα κρατούν την πόρτα κλειστή με ασφάλεια κατά τη μεταφορά.

**FULL 270° ACCESS**  
Durable hinges and latches allow the door to open 270° and remain open securely to the side of the front loader for easy access to products. Latches keep door securely closed during transport.



«Cam GoBox GN»  
EPP



ισοθερμικά δοχεία άνω φόρτωσης για GN  
*insulated lightweight top loader carriers for GN pans*

92.20007 EPP260110  
ισοθερμικό δοχείο για GN 1/2 - 15 cm  
*top loader carrier for 15 cm GN 1/2*  
16,9 lt  
(εσωτ./interior: 33x27 cm | 19,3 cm)  
39x33 cm | 25,7 cm  
pack: 1



92.20008 EPP280110  
ισοθερμικό δοχείο για GN 1/2 - 20 cm  
*top loader carrier for 20 cm GN 1/2*  
22,3 lt  
(εσωτ./interior: 33x27 cm | 25,3 cm)  
39x33 cm | 31,6 cm  
pack: 1



ισοθερμικά δοχεία εμπρόσθια; φόρτωσης για GN  
*insulated lightweight front loader carriers for GN pans*

92.20009 EPP300110  
ισοθερμικό δοχείο για GN 1/1  
*front loader carrier for GN 1/1*  
60 lt  
(εσωτ./interior: 53,5x33 cm | 37 cm)  
64x44 cm | 47,5 cm  
pack: 1

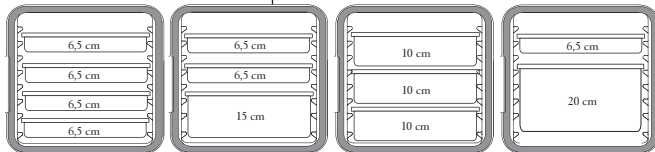

92.20005 EPP160110  
ισοθερμικό δοχείο για GN 1/1 - 15 cm  
*top loader carrier for 15 cm GN 1/1*  
35,5 lt  
(εσωτ./interior: 53,8x33,8 cm | 19,3 cm)  
60x40 cm | 25,7 cm  
pack: 1



92.20006 EPP180110  
ισοθερμικό δοχείο για GN 1/1 - 20 cm  
*top loader carrier for 20 cm GN 1/1*  
46 lt  
(εσωτ./interior: 53,8x33,8 cm | 25,3 cm)  
60x40 cm | 31,6 cm  
pack: 1



92.20011 EPP400110  
ισοθερμικό δοχείο για GN 1/1  
*front loader carrier for GN 1/1*  
86 lt  
(εσωτ./interior: 53,5x33 cm | 52,5 cm)  
64x44 cm | 62,5 cm  
pack: 1

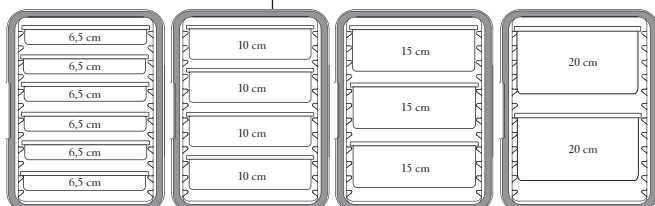

τρόλει μεταφοράς GN 1/1 «Camdolly»

92.20000 CD3253EPP158  
τρόλει μεταφοράς ισοθερμικών GN 1/1  
για EPP300 & EPP400  
«Camdolly» fits GN 1/1 «Cam GoBoxes»  
pack: 1





για την χρήση των διαχωριστικών ανατρέξτε

σελίδα **498**  
ΚΟΥΖΙΝΑ

«Cam GoBox 4060»

Το «Cam GoBox 4060 front loader» έχει πολλαπλές χρήσεις. Μπορεί, (με την εγκατάσταση ανοξείδωτων πλαισίων με ρυθμιζόμενες ράγες) να τροποποιηθεί από απλό δοχείο EPP σε μια ενέδμητη μονάδα και να μεταφέρει συνδυασμούς 60x40 cm καθαυτών, δίσκων, ταψιών ζαχαροπλαστικής και όχι μόνο.

Το «Cam GoBox 4060 top loader» χάρis την μεγάλη του εσωτερική διάσταση 42,5x62,5x30,5 cm χωρά μεγάλες ποσότητες μερίδων φαγητού.

Multi-purpose front-loader can be modified from a non-molded in rail carrier to a versatile unit by installing optional, stainless steel adjustable rails for transporting a combination of 60x40 cm crates, baking pans and trays, all in the same carrier.

ισοθερμικά δοχεία 60x40 εμπρόσθια φόρτωσης  
*insulated lightweight front loader carriers for 60x40 pans*



**92.20012** EPP4060FNR  
ισοθερμικό δοχείο για 60x40 cm χωρίς πλαίσιο και ράγες  
*front loader carrier for 60x40 cm without rail*  
155 lt  
(εσωτ./interior: 61,5x41 cm | 58,5 cm)  
77x54 cm | 68,7 cm  
pack: 1



**92.20013** EPP4060F9R  
ισοθερμικό δοχείο για 60x40 cm με 9 ράγες inox  
*front loader carrier for 60x40 cm with 9 adjustable inox rails*  
126 lt  
(εσωτ./interior: 61,5x41 cm | 58,5 cm)  
77x54 cm | 68,7 cm  
pack: 1

ισοθερμικά δοχεία 60x40 άνω φόρτωσης  
*insulated lightweight top loader carriers for 60x40 pans*



**92.20014** EPP4060T300110  
ισοθερμικό δοχείο βάθους 30 cm  
*top loader, 30 cm deep*  
80 lt  
(εσωτ./interior: 42,5x62,5 cm | 30,5 cm)  
49x69 cm | 37 cm  
pack: 1

αξεσουάρ «Cam GoBox 4060» accessories



**92.20002** CD4060EPP  
τρόλεϊ μεταφοράς δοχείων 60x40  
*«Camdolly» for «Cam GoBox 4060»*  
71x51 cm | 16 cm  
pack: 1

αξεσουάρ «Cam GoBox» accessories

	<b>92.20003</b> CP3253443 πλάκα με ψυκτικό υγρό GN 1/1 <i>«CamChiller» cold plate GN 1/1</i> 53x32,5 cm   3 cm pack: 1
	<b>92.20015</b> HP3253444 πλάκα θέρμανσης GN 1/1 <i>«CamWarmer» hot plate GN 1/1</i> 53x32,5 cm   3 cm pack: 1
	<b>92.20010</b> EPP3253DIV110 θερμικός διαχωριστής για EPP300 & EPP400 <i>«ThermoBarrier» fits EPP300 and EPP400</i> 53x32,7 cm   3,7 cm pack: 1

κοινά αξεσουάρ για «Cam GoBox» accessories

	<b>92.20018</b> EPP4060FPR1 2 inox πλαίσια με 4 ράγες για το EPP4060FNR <i>kit of 4 stainless steel rails + 2 frames for EPP4060FNR</i> pack: 1
--	--

κοινά αξεσουάρ για «Cam GoBox» accessories

	<b>92.20004</b> EPP3253DIV πλαστικές χρωματιστές επικέτες για όλα τα «Cam GoBoxes» <i>Plastic ID labels fits all «Cam GoBoxes»</i> pack: 1
--	---



## «Ultra CamCart»

- Durable and dependable front-loading food pan carriers.
- Hold multiple pans of hot or cold food at safe temperatures for hours.
- Seamless polyethylene with thick foam insulation.

### ΕΡΓΟΝΟΜΙΚΟΣ ΣΧΕΔΙΑΣΜΟΣ

Ενσωματωμένες λάβες για άνετη μεταφορά.

### ERGONOMIC DESIGN

Unbreakable, ergonomic, molded-in handles for comfortable two-person carrying.

### ΕΛΕΓΧΟΣ ΠΙΕΣΗΣ ΚΑΙ ΥΓΡΑΣΙΑΣ

Με οπή εξαερισμού.

### PRESSURE AND HUMIDITY CONTROL

Pop-up vent.

### ΑΦΑΙΡΟΥΜΕΝΟ ΛΑΣΤΙΧΟ

Για αεροστεγή σφράγιση.

### REMOVABLE GASKET

Provides an airtight seal.



Το ανθεκτικότερο και πιο αξιόπιστο ισοθερμικό δοχείο μεταφοράς τροφίμων της αγοράς.

- Κρατούν ζεστά ή κρύα τα τρόφιμα σε ασφαλείς θερμοκρασίες για πολλές ώρες.
- Εύκολα στη συντήρηση και δεν παρουσιάζουν ρωγμές, σκουριά, ξεφλούδισμα ή σπάσιμο. Μοινοκόμιατη κατασκευή με ποχύ παχύ αφρό μόνωσης.

**ΔΙΑΤΗΡΗΣΗ ΘΕΡΜΟΚΡΑΣΙΑΣ**  
Η μόνωση πολυουρεθάνης κρατά αποεισεμαϊκά ζεστό ή κρύο το φαγητό.

**TEMPERATURE RETENTION**  
Polyurethane insulation keeps hot food hot and cold food cold.

**ΓΡΗΓΟΡΗ ΠΡΟΣΒΑΣΗ**  
Νάϊον μάνιαδο 23 cm για γρηγορό και ασφαλές κλείσιμο.

**QUICK ACCESS**  
Single, 23 cm nylon latch for quick and secure opening and closing.

για την χρήση των διαχωριστικών ανατρέξτε

σελίδα **498** ΚΟΥΖΙΝΑ

## «Ultra CamCart» GN

	<b>92.00600</b> UPC400401 ισοθερμικό δοχείο για 6 GN 1/1 μπλε front loader carrier 6 GN 1/1 slate blue (εσωτ./interior: 34x53,5 cm   36 cm) 42,5x62 cm   57 cm pack: 1
	<b>92.00601</b> UPC400131 ισοθερμικό δοχείο για 6 GN 1/1 καφέ front loader carrier 6 GN 1/1 dark brown (εσωτ./interior: 34x53,5 cm   36 cm) 42,5x62 cm   57 cm pack: 1
	<b>92.00602</b> UPC400157 ισοθερμικό δοχείο για 6 GN 1/1 μπεζ front loader carrier 6 GN 1/1 coffee beige (εσωτ./interior: 34x53,5 cm   36 cm) 42,5x62 cm   57 cm pack: 1

## αξεσουάρ για «Ultra CamCart H-Series» accessories

	<b>92.20003</b> CP3253443 πλάκα με ψυκτικό υγρό GN 1/1 «CamChiller» cold plate GN 1/1 53x32,5 cm   3 cm pack: 1
	<b>92.20015</b> HP3253444 πλάκα θέρμανσης GN 1/1 «CamWarmer» hot plate GN 1/1 53x32,5 cm   3 cm pack: 1
	<b>92.20016</b> 400DIV180 θερμικός διαχωριστής για UPC800 «ThermoBarrier» fits UPC800 53x32,7 cm   2,5 cm pack: 1
	<b>92.20001</b> CD400401 τρόλει μεταφοράς «UPCH4002» «Camdolly» fits «UPCH4002» 71x53 cm   23 cm pack: 1
	<b>92.20017</b> 400STP000 μιάνας μεταφοράς ισοθερμικών, 5 m δοχείων   strap, 5 m long pack: 1



«Ultra CamCart»

διατήρηση ζεστών - Hot

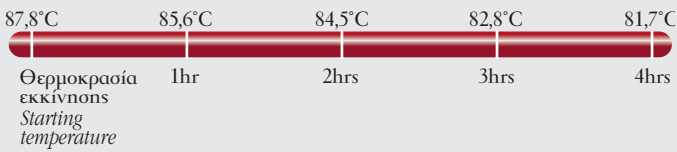

διατήρηση κρύων - Cold

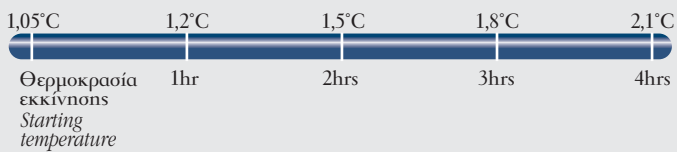

χωρητικότητα capacity guide				
UPC400	6 GN - 6,5 cm	4 GN - 10 cm	3 GN - 15 cm	2 GN - 20 cm
UPC800	12 GN - 6,5 cm	8 GN - 10 cm	6 GN - 15 cm	4 GN - 20 cm
UPC1600	24 GN - 6,5 cm	16 GN - 10 cm	12 GN - 15 cm	8 GN - 20 cm

διόροφα «Ultra CamCart» GN - double-compartment

Δύο δοχεία σε ένα. Μεγάλη χωρητικότητα για μεταφορά ζεστών ή κρύων. Ειδικά σχεδιασμένο για την περίπτωση που η ασφάλεια αποδειεί προτεραιότητα. Ανθεκτικό στην φθορά συνδετήρες. Πόριες που δεν αποσπίνονται και δάμα με ιρύπα για να κδειύνει (το δονκέτο δεν περιέχεται). Μόνωση ποδουρεθάνης κρατά αποιδεοματικά και τα ζεσιά και τα κρύα.

Double-compartment, high-capacity carts hold and transport hot or cold food. Tough, polyethylene shell and thick foam insulation throughout cabinet and between compartments. Airtight removable gaskets maintain safe food temperatures for hours. Easy to maintain and won't dent, crack, rust, chip or break. Durable nylon door latches open easily and close securely. Full-swing doors open to the side of the cart for easy loading and unloading.

	<p>92.00606 <span style="float: right;">UPC800401</span>                      ισοθερμικό δοχείο για 12 GN 1/1 με ρόδες, καφέ  <i>front loader carrier 12 GN 1/1 with casters, dark brown</i>                      (εσωτ./interior: 33x54,5 cm   48,5 cm)                      52x69 cm   137 cm                      pack: 1</p>		<p>92.00603 <span style="float: right;">UPC1600401</span>                      ισοθερμικό δοχείο για 24 GN 1/1 με ρόδες, μπλε  <i>front loader carrier 24 GN 1/1 with casters, slate blue</i>                      (εσωτ./interior: 53,5x66,5 cm   53,5 cm)                      71,5x82 cm   135 cm                      pack: 1</p>
	<p>92.00605 <span style="float: right;">UPC800131</span>                      ισοθερμικό δοχείο για 12 GN 1/1 με ρόδες, καφέ  <i>front loader carrier 12 GN 1/1 with casters, dark brown</i>                      (εσωτ./interior: 33x54,5 cm   48,5 cm)                      52x69 cm   137 cm                      pack: 1</p>		<p>92.00604 <span style="float: right;">UPC1600401</span>                      ισοθερμικό δοχείο για 24 GN 1/1 με ρόδες, καφέ  <i>front loader carrier 24 GN 1/1 with casters, slate blue</i>                      (εσωτ./interior: 53,5x66,5 cm   53,5 cm)                      71,5x82 cm   135 cm                      pack: 1</p>





## διατήρηση θερμοκρασίας - βέλτιστη απόδοση

Χρησιμοποιώντας σωστά τον χώρο του θαλάμου και την κατάλληλη πλάκα - χύρισμα που μπορείτε προαιρετικά να προμηθευτείτε επιπυχνάνετε για μακρύτερο χρονικό διάστημα την διατήρηση της επιθυμητής θερμοκρασίας αποφεύγοντας τις δυσάρεστες συνέπειες.

Όλα τα ισοθερμικά δοχεία έχουν σχεδιαστεί να έχουν αρκετό χώρο για τα δοχεία GN και για το θερμαινόμενο ή ψυκτικό στοιχείο (Camwarmer ή camchiller) όταν αυτό είναι επιθυμητό. Καλύτερα αποειδέσματα επιπυχνώνονται όταν τα δοχεία GN που θα τοποθετηθούν ισοθερμικά δοχεία έχουν θερμοκρασία μεταξύ 82°C. και 88°C. Τα μεταδίδικά GN σε θερμοκρασίες άνω των 120°C. θα προκαλέσουν ζημιά στα ισοθερμικά δοχεία.

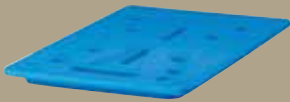

αποθήκευση κρύων | cold holding

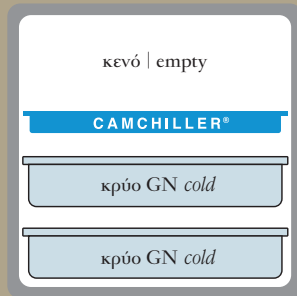
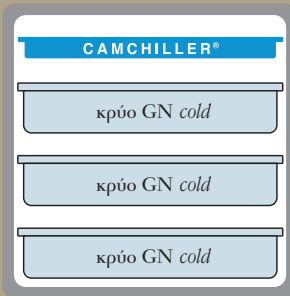

αποθήκευση ζεστών | hot holding

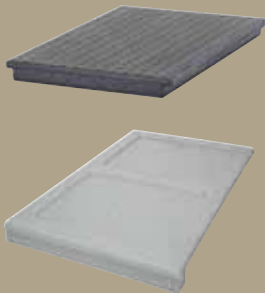
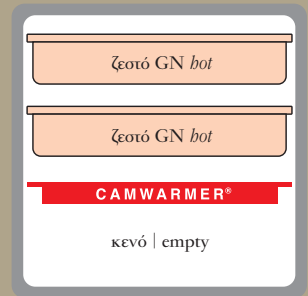
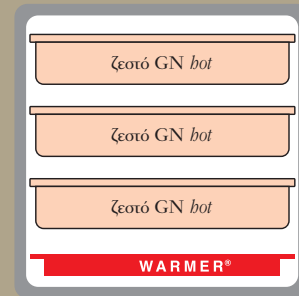

αποθήκευση ζεστών και κρύων | hot and cold holding

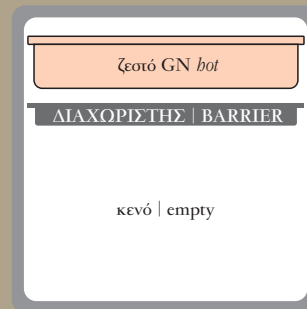
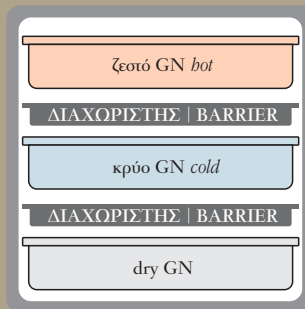

## «CamTainers»

ισοθερμικά δοχεία μεταφοράς υγρών  
insulated beverage containers

Διατηρούν, μεταφέρουν και σερβίρουν ζεστά ή κρύα ροφήματα. Μονοκόμμη κατασκευή με ομοιόμορφα κατανεμημένο παχύ αφρό. Στοιβάζονται για εύκολη μεταφορά και αποθήκευση.

Use to hold, transport and serve hot or cold beverages. One piece, seamless double-wall polyethylene with thick foam insulation. Sta-stack interlocking ensures stable stacking during transport and storage.



92.00610  
500LCD131  
ισοθερμικό δοχείο μεταφοράς υγρών insulated beverage container,  
17,9 lt  
42x23 cm | 62 cm  
pack: 1





«Ultra CamCart H-Series» GN 1/1

ηλεκτρικά ισοθερμικά δοχεία εμπρόσθιας φόρτωσης  
*electric front loader carriers*

	<p><b>92.00609</b> <span style="float: right;">UPCH4002</span> ηλεκτρικό ισοθερμικό δοχείο, μπλε για 6 δοχεία GN 1/1 χωρίς ρόδες <i>electric front carrier for 6 GN 1/1 no casters, blue</i> 265 W - 220-230 V - 50/60 Hz (εσωτ./interior: 33,5x53,3 cm   48,6 cm) 46x67 cm   63 cm pack: 1</p>
	<p><b>92.00607</b> <span style="float: right;">UPCH8002</span> ηλεκτρικό ισοθερμικό δοχείο, μπλε για 12 δοχεία GN 1/1 with casters, blue <i>electric front carrier for 12 GN 1/1 with casters, blue</i> 265 W - 220-230 V - 50/60 Hz (εσωτ./interior: 33x54,5 cm   48,5 cm) 52x69 cm   137,2 cm pack: 1</p>
	<p><b>92.00608</b> <span style="float: right;">UPCH16002</span> ηλεκτρικό ισοθερμικό δοχείο, μπλε για 24 δοχεία GN 1/1 with casters, blue <i>electric front carrier for 24 GN 1/1 with casters, blue</i> 506 W - 220-230 V - 50/60 Hz (εσωτ./interior: 53,5x66,5 cm   53,5 cm) 73x84,7 cm   137,5 cm pack: 1</p>

- Σχεδιασμένα να διατηρούν ζεστά τα τρόφιμα με ή χωρίς χρήση ηλεκτρικού ρεύματος.
- Ήπια θερμοκρασία διατήρησης 65-74°C, κρατά την υγρασία των φαγητών.
- Σημαντικά δηγότερη κατανάλωση από τα αντίστοιχα μεταδιδικά τρόδεϊ.
- Όλα τα μοντέλα τρόδεϊ UPCH μπορούν να διατηρήσουν το περιεχόμενό τους για 4 περίπου ώρες χωρίς ρεύμα.
- Χρόνος προθέρμανσης από θερμοκρασία δωμάτιου 50' . Χρόνος επαναφοράς θερμοκρασίας μετά το άνοιγμα της πόρτας για 30 δευτερόλεπτα, περίπου 3 λεπτά.
- Designed for both electric hot holding and non-electric transport.
- Gentle, 65-74°C non-radiant heat will not cook food and maintains food moisture.
- One hour preheat time from room temperature and three minute recovery.
- Energy consumption is substantially less than comparable metal cabinets.
- Will not rust or dent like metal cabinets, is more economical, and is easy to maneuver.
- All UPCH models have been tested to maintain safe, hot food temperatures, for up to 4 hours when unplugged.

χωρητικότητα  
*capacity guide*

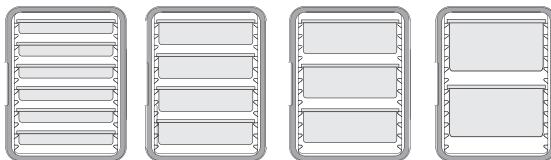

UPCH4002	6 GN - 6,5 cm	4 GN - 10 cm	3 GN - 15 cm	2 GN - 20 cm
UPCH8002	12 GN - 6,5 cm	8 GN - 10 cm	6 GN - 15 cm	4 GN - 20 cm
UPCH16002	24 GN - 6,5 cm	16 GN - 10 cm	12 GN - 15 cm	8 GN - 20 cm

διατήρηση ζεστών εκτός ρεύματος

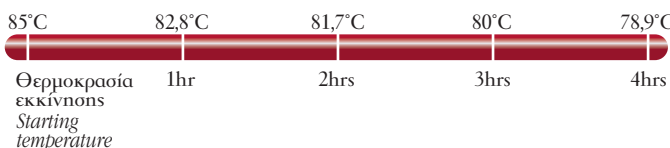



τρόδει Banquet

**B.PRO**  
CATERING SOLUTIONS

## τρόδει banquet θερμανόμενα Banquet trolleys heated



τρόδει θερμανόμενο BW-36  
για 36 GN 2/1 - 6,5 cm  
139x94,5 cm | 192 cm  
(διατίθεται και για 11 - 18 22 - GN 2/1)

- Διπλού τοιχώματος με μόνωση
- Σύμα κατασκευασμένο από ανοξείδωτο ατσάλι, κλειστό σε όλες τις πλευρές, εξωτερικό και εσωτερικό σύμα με θερμικό διαχωρισμό
- Διαμέρισμα σε υγιεινό τύπο HS, σχάρες και δοχεία GN κάθονται πάνω σε ενσωματωμένες στο τοίχωμα προεξοχές.
- Θερμαντικό στοιχείο με σύστημα θέρμανσης μεταφοράς αέρα, μπορεί να θερμανθεί ξηρό ή βρεγμένο, αναιρούμενο για τον καθαρισμό.
- Ηλεκτρονικός έλεγχος θερμοκρασίας, με ψηφιακό σημείο ρύθμισης/πραγματική οθόνη. Εύρος θερμοκρασίας από +30 °C έως +90 °C
- 220-240 V / 50 -60 Hz / 2,2 kW
- Σπράτ καθήκιο μήκους 62,5 εκ έως 2,1 μέτρα.
- Ο προφίλακτιρας γύρω από το τρόδει το προστατεύει από τα χιπήματα.
- Αυτόματο κλείσιμο, κλείδωμα 2 σημείων για ασφαλή μεταφορά (με θέση ασφαλείας), που κλειδώνει

Banquet trolleys, heated

- Double-walled and insulated
- Body made of stainless steel, closed on all sides, exterior and interior body with thermal separation
- Compartment in hygienic type HS, grates and GN containers held by deep-draw ledge walls.
- Heating element with air convection heating system, can be heated dry or wet, removable for cleaning.
- Electronic temperature control, with digital setpoint/actual display, temperature range adjustable from +30°C and +90°C.
- Connected load 220-240 V / 50-60 Hz / 2.2 kW.
- Helix cable with block length of 0.625m, extendable up to 2.1m.
- All round bumper rail protects trolley from being damaged.
- Self-closing 2-point lock, secure for transport (with safety position), lockable.

## τρόδει banquet ψυχόμενα Banquet trolleys convection-cooled



τρόδει ψυχόμενο BW-UK 10  
για 10 GN 2/1 - 10 cm  
84x94,5 cm | 192 cm  
(διατίθεται και για 15 GN 2/1)

- Διπλού τοιχώματος με μόνωση
- Σύμα κατασκευασμένο από ανοξείδωτο ατσάλι, κλειστό σε όλες τις πλευρές, εξωτερικό και εσωτερικό σύμα με θερμικό διαχωρισμό
- Διαμέρισμα σε υγιεινό τύπο HS, σχάρες και δοχεία GN κάθονται πάνω σε ενσωματωμένες στο τοίχωμα προεξοχές.
- Ενσωματωμένη μονάδα ψύξης στο σύμα.
- Ηλεκτρονικός έλεγχος θερμοκρασίας, με ψηφιακό σελ/πραγματική οθόνη, ρυθμιζόμενη από +8°C έως -10°C.
- 220-40 V / 50 Hz ή 60 Hz / 0,5 kW
- Σπράτ καθήκιο μήκους 62,5 εκ έως 2,1 μέτρα.
- Ο προφίλακτιρας γύρω από το τρόδει το προστατεύει από τα χιπήματα.
- Αυτόματο κλείσιμο, κλείδωμα 2 σημείων για ασφαλή μεταφορά (με θέση ασφαλείας), που κλειδώνει.

Banquet trolleys, cooled

- Double-walled and insulated
- Body made of stainless steel, closed on all sides, exterior and interior body with thermal separation
- Compartment in hygienic type HS, grates and GN containers held by deep-draw ledge walls.
- Refrigeration unit integrated in unit body.
- Electronic temperature control, with digital setpoint/actual display, temperature range adjustable from -10°C and +8°C.
- Connected load 220-240 V / 50-60 Hz / 0.5 kW.
- Helix cable with block length of 0.625m, extendable up to 2.1m.
- All round bumper rail protects trolley from being damaged.
- Self-closing 2-point lock, secure for transport (with safety position), lockable.



τρόχει μεταφοράς πιάτων «S-Series» dish caddy

	<p><b>92.00612</b> ADCSC480                  τρόχει μεταφοράς πιάτων «dish caddy»                  compact adjustable dish caddy «S-Series»                  68,6x68,6 cm   80,7 cm                  pack: 1</p>
	<p><b>92.00613</b> ADCSCT4480                  ανταλλακτική κολώνα                  CamLever tower for dish caddy                  6,7x11,1 cm   59,7 cm                  pack: 1</p>

Μέγιστη απόδοση από το πιο μικρό τρόδεϊ πιάτων. Αξιοποιήστε το κάθε τετραγωνικό εκατοστό του χώρου σας. Ιδανικό για μικρούς και μεγάλους χώρους, το compact ρυθμιζόμενο τρόδεϊ πιάτων δεσμεύει μικρότερο χώρο να υστερεί σε απόδοση ή αποθηκευτική ικανότητα. Χάρη στον μικρό του όγκο κυκλοφορεί ανετά και γρηγορά και επιπλέον, χάρη στην καινοτομία, το καθίσταται ποδύ δειονομικό και εύκοδο στην χρήση διάφορων σε μέγεθος πιάτων.

*Maximum Performance in a Small Footprint*  
 Make every square inch of your floor space count. Ideal for both small and large venues, the Compact Adjustable Dish Caddy offers a smaller footprint without compromising performance or storage capacity.

Στοιβάζει και μεταφέρει με ασφάλεια στρογγυλά πιάτα από 11,7 έως 30,5 cm. (Μη καιάδηδο για τεράγωνα ή οβάλ πιάτα)

Securely store and transport round dishes from 11,7 to 30,5 cm. Note: Cannot be used to store square, rectangular or oval plates.



Περιλαμβάνεται κάλυμμα βινυλίου  
 Vinyl cover included



Μεταφέρει μέχρι 227 kgr.

Load bearing capacity 227 kg.

Δύο ενσωματωμένες χωνευτές άβες στις 4 πλευρές.

Two each molded-in top handles plus recessed handles on all four sides.

Εξωτερικές διαστάσεις 68,6x68,6 cm | 80,70 cm

Exterior Dimensions 68,6x68,6 cm | 80,70 cm

Κρατά τα πιάτα 22,8 cm από το έδαφος με ελεύθερο περιθώριο από το έδαφος 15,2 cm.

Holds dishes 22,8 cm safely up from the floor with 15,2 cm clearance under the unit.



Υψος στοιβάς πιάτων 52,1 cm, περίπου 70 πιάτων ανάλογα με το πάχος και το σχέδιο.

Dish stacking height 52,1 cm. Store up to 70 dishes per stack, based on dish type/style.

Λεία επιφάνεια με στρογγυλεμένες γωνίες που διατηρείται ευκολά καθαρό.

Smooth surface and rounded corners are easy to keep clean.

Μονοκόμμιαι κατασκευή από ποδιναιθυλένιο υψηλής ανθεκτικότητας που δεν παρουσιάζει σκουριά, ρυγμές και βαθουλώματα.

One-piece molded body made of highly durable polyethylene, won't rust, crack or dent.

4 περιστρεφόμενες μεταλλικές ρόδες 12,7 cm με φρένο και με έδαση 3,2 cm που δεν αφήνουν ίχως.

Four (4) each 12,7 cm zinc plated casters, all swivel with brake with non-marking highly durable 3,2 cm TPE tread.

συνθέσεις στοιβάξης - storage configurations

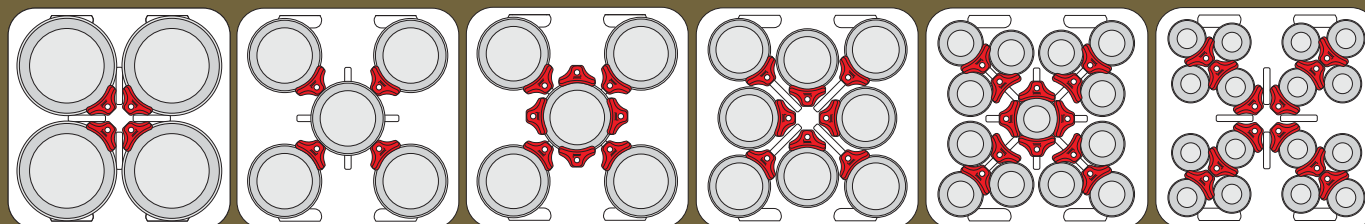

πιάτα 23,5-30,5 cm  
 4 στοιβες  
 έως 280 πιάτα

πιάτα 22,9 cm  
 5 στοιβες  
 έως 350 πιάτα

πιάτα 19,7-22,2 cm  
 5 στοιβες  
 έως 350 πιάτα

πιάτα 14,6-19,1 cm  
 8 στοιβες  
 έως 560 πιάτα

πιάτα 12,1-13,3 cm  
 13 στοιβες  
 έως 910 πιάτα

πιάτα 11,7 cm  
 16 στοιβες  
 έως 1.120 πιάτα



πλύσιμο - μεταφορά - αποθήκευση  
ποτηριών & πιάτων

HACCP



CAMBRO

## «CamRack»

Το σύστημα «CamRack» θα προστατεύσει τα ποτήρια σας από οπασίματα και θα τα διατηρήσει καθαρά σε άριστη κατάσταση μέχρι την επόμενη χρήση τους μέσα ή έξω από τον χώρο σας χωρίς να χρειάζονται ξανά πλύσιμο.

The Camrack System will protect glassware and keep it clean until the next event, eliminating the need for rewashing.

- Το ανοικτό εσωτερικό, επιτρέπει το τέλειο πλύσιμο και το αποτελεσματικό στέγνωμα. Το άριστης ποιότητας ποδυπροπυλένιο προσφέρει στα καθατιά αντοχή δεκαετιών χωρίς να δημιουργούν πρόβλημα στα πδντήρια.
- Τα κλειστά εξωτερικά τοιχώματα εγγυώνται την υγιεινή και ασφαδή φύλαξη των ποτηριών. Το καπάκι κδεινει ερμητικά από πάνω στα καθατιά.
- Τα διαφορετικά χρώματα των καθαθιών βοηθούν στην αναγνύριση του ποτηριού που φυδάσεται μέσα και στην γρήγορη καταμέριση του. Διαθέσιμα χρώματα, γκρι, μπδε, μαύρο, κόκκινο, πράσινο, cranberry.
- Εύκοδη και ασφαδής μετακίνηση μέσα σε κδεισιούς ή ανοικτούς χώρους.

- Open inside compartments provide thorough circulation of water and cleaning solutions and promote quick and thorough drying.
- Closed outer walls keep fingers and contaminants out and reduce risk of breakage and injury. The Camrack cover and Camdolly make this system completely enclosed. Glassware stays clean when in storage, so operators will only have to wash items once.
- A variety in base rack colors help identify at a glance both contents and quantity per rack. Available in 10 colors.
- Camracks can be transported across large campuses or to off-site locations in one single unit. Easy to grip handles and smooth overlapping sides facilitate safe handling.

502

ΚΑΛΑΓΙΑ ΠΛΥΝΤΗΡΙΟΥ

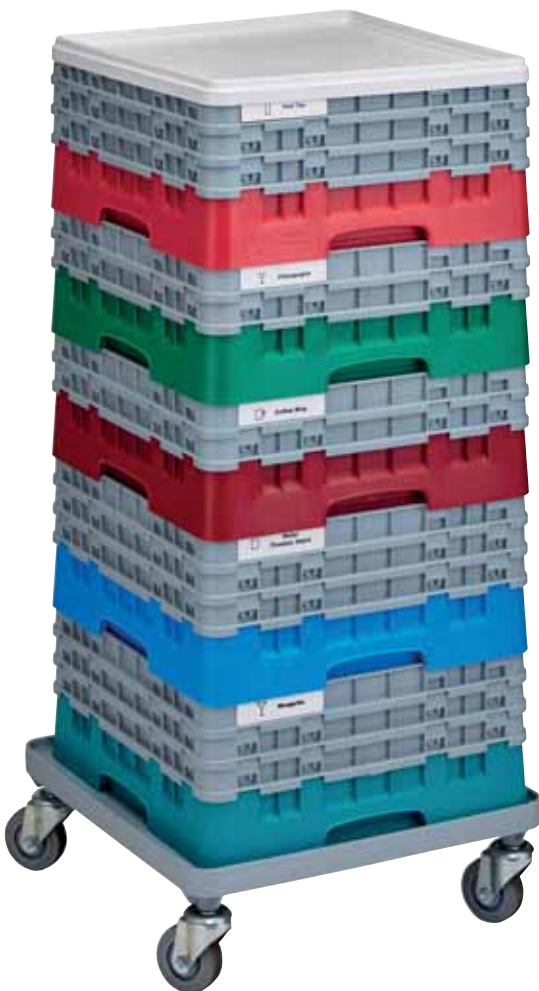

OXI βρώμικα χέρια  
NO dirty hands



OXI βακτήρια  
NO bacteria



OXI τρωκτικά  
NO rodents



OXI έντομα  
NO bugs



OXI βρώμικα νερά  
NO dirty mop water





**ΔΗΜΙΟΥΡΓΟΝΤΑΣ ΤΗΝ ΣΩΣΤΗ ΠΟΤΗΡΟΘΗΚΗ**

- *Επιλέγουμε το χρώμα του βασικού καλαθιού «BR258» που πλέον θα αντιστοιχεί σε κάποιο συγκεκριμένο ποτήρι.*
- *Στην συνέχεια, πάντα τοποθετούμε πρώτα μία προέκταση «E1 full drop» που να χωρά ακριβώς το ποτήρι μας στο πιάτος και μετά μία ή και περισσότερες προεκτάσεις «E2 half drop» του ίδιου πιάτους, όσες χρειάζονται δηλαδή για να φθάσουμε το ύψος του ποτηριού μας.*
- *Μετράμε πάντα το εσωτερικό ύψος καλαθιού και της προέκτασης. Το καλάθι BR258 έχει εσωτερικό ύψος 8,3 cm και κάθε προέκταση εσωτερικό ύψος 4,1 cm.*
- *Έτσι έχουμε άμεση αναγνώριση του ποτηριού που είναι μέσα στην ποτηροθήκη και καθιστούμε εύκολη την καταμέτρησή τους.*
- *Θα βρείτε πιο κάτω όλες τις πληροφορίες για τα καλάθια και προεκτάσεις, χρώματα, εσωτερικές και εξωτερικές διαστάσεις, αριθμό και διαστάσεις χωρισμάτων, κ.ά.*

**CREATING THE RIGHT CAMRACK**

- *We take one basic rack BR258. We choose a color for this rack. We choose a glass of our collection. From now on this color will represent this specific glass. We always add firstly one full drop extender.*
- *Our glass should fit in this extender. Then we add one or more E2 half drop extenders until we reach the height of the glass.*
- *We always measure the internal height of rack and extender. The rack BR258 has internal height 8.3 cm and the extender 4.1 cm.*
- *Thus it is easy to identify we glass is inside the rack and has fast inventory check.*
- *You find below all the information you need for the racks and the extenders.*

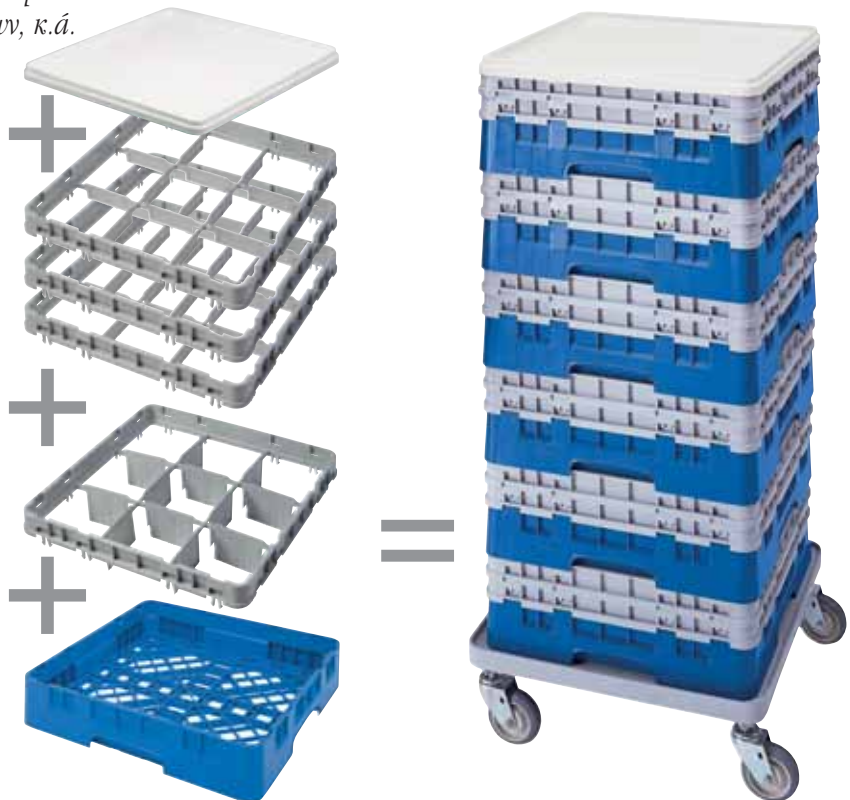

**ΕΠΙΛΕΓΟΝΤΑΣ ΤΗΝ ΣΩΣΤΗ ΠΡΟΕΚΤΑΣΗ**

1. *Μετράμε την μέγιστη διάμετρο του ποτηριού για να βρούμε τον αριθμό των χωρισμάτων.*
2. *Μετράμε το ύψος του του ποτηριού για να βρούμε το εσωτερικό ύψος της ποτηροθήκης που θέλουμε.*

**CHOOSE THE CORRECT EXTENDER**

1. *Measure the maximum diameter of your glass (stemware or tumbler) to determine the number of compartments.*
2. *Measure the maximum height of your glass (stemware or tumbler) to the top edge of the rim to determine the compartment height.*

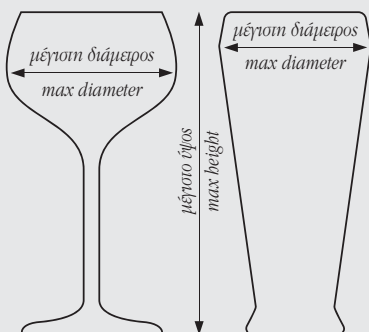



καλάθια γενικής χρήσης «Full» | «Full» base rack (50x50 cm | 10,1 cm)



92.00011 BR258151  
καλάθι «Full», γκρι  
full base rack «soft gray»  
pack: 1/6



92.00010 BR258186  
καλάθι «Full», μπλε  
full base rack «navy bleu»  
pack: 1/6



92.00013 BR258110  
καλάθι «Full», μαύρο  
full base rack «black»  
pack: 1/6

Καλάθι πιάτων και μπολ  
διπλής κατεύθυνσης,  
5x9 θέσεων:

- κατεύθυνση 5 προεξοχών  
δέχεται έως  
10 μπολ 25,4 cm,  
βαθιά πιάτα, πιατέλες και  
καπάκια πιάτων.

- κατεύθυνση 9 προεξοχών  
δέχεται  
- 18 πιάτα 25 cm  
- 12 πιάτα 30,5 cm  
- 27 πιάτα 19 cm ή  
- 9 δίσκους 36x46 cm.

5x9 peg rack

Holds standard plates in one  
direction or deep plates, bowls and  
plate covers in the other direction.

- 5 spacing configuration holds  
up to ten 25,4 cm bowls, deep  
plates, platters or plate covers.

- 9 spacing configuration holds  
up to:

- Eighteen 25,4 cm plates
- Twelve 30,5 cm plates
- Twenty-seven 19 cm plates or
- Nine 36x46 cm trays.



92.00012 BR258163  
καλάθι «Full», κόκκινο  
full base rack «red»  
pack: 1/6



92.00015 BR258119  
καλάθι «Full», πράσινο  
full base rack «green»  
pack: 1/6



92.00014 BR258416  
καλάθι «Full», μμπορντώ  
full base rack «cranberry»  
pack: 1/6

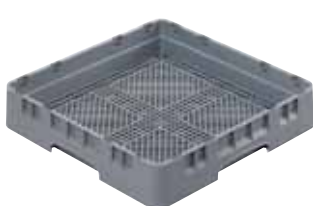

92.00032 FR258151  
καλάθι γενικής χρήσης/  
μαχαιροπίρουνων, «Full», γκρι  
flatware rack «Full»  
pack: 1/6



92.00031 E3151  
προέκταση ανοιχτή, γκρι  
full size open extender  
pack: 12



92.00035 DRC2020180  
καπάκι για καλάθια, γκρι  
«Full» rack cover  
50x50 cm | 2,4 cm  
pack: 1

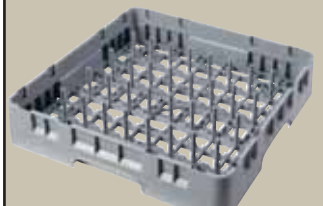

92.00033 PR59314151  
καλάθι πιάτων/δίσκων «Full»,  
γκρι, 5x9  
5x9 peg rack «Full», gray  
pack: 6

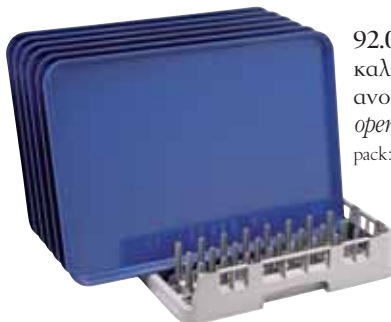

92.00030 OETR314151  
καλάθι δίσκων «Full», γκρι,  
ανοικτό από τη μια πλευρά,  
open end tray rack gray  
pack: 6



92.00036 8FBNH434151  
καλάθι μαχαιροπίρουνων, γκρι  
flatware basket, gray  
pack: 6



92.00040 CDR2020H151  
τρόλεϊ μεταφοράς καλαθιών με λαβή  
camdolle for racks with handle  
54,5x59,5 cm | 94 cm  
αντοχή/capacity: 159 kgr  
pack: 1











92.00034 CDR2020151  
τρόλεϊ μεταφοράς καλαθιών | camdolle for racks  
54,5x53 cm | 18,7 cm (εσωτ./interior: 53x53 cm)  
αντοχή/capacity: 159 kgr  
pack: 1





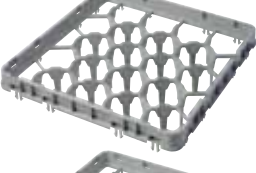
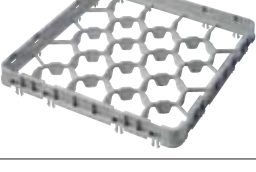

(49,9x49,9 cm | 5,1 cm)

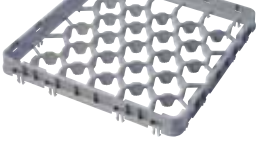
προεκτάσεις καλαθιών «CamWare®» extenders

	<b>92.00018</b> <span style="float: right;">9E1151</span> προέκταση «Full» γκρι, 9 θέσεων <i>9 compartements extender; gray</i> (14,9x14,9 cm) pack: 12
	<b>92.00025</b> <span style="float: right;">9E2151</span> προέκταση «Half» γκρι, 9 θέσεων <i>9 compartements extender* Half; gray</i> (14,9x14,9 cm) pack: 12
	<b>92.00019</b> <span style="float: right;">16E1151</span> προέκταση «Full» γκρι, 16 θέσεων <i>16 compartements extender; gray</i> (11,11x11,11 cm) pack: 12
	<b>92.00026</b> <span style="float: right;">16E2151</span> προέκταση «Half» γκρι, 16 θέσεων <i>16 compartements extender* Half; gray</i> (11,11x11,11 cm) pack: 12
	<b>92.00016</b> <span style="float: right;">20GE1151</span> προέκταση «Full» γκρι, 20 θέσεων <i>20 compartements extender; gray</i> (6,2x6,2 cm) pack: 12
	<b>92.00023</b> <span style="float: right;">20GE2151</span> προέκταση «Half» γκρι, 20 θέσεων <i>20 compartements extender* Half; gray</i> (6,2x6,2 cm) pack: 12
	<b>92.00020</b> <span style="float: right;">25E1151</span> προέκταση «Full» γκρι, 25 θέσεων <i>25 compartements extender; gray</i> (8,7x8,7 cm) pack: 12
	<b>92.00027</b> <span style="float: right;">16E2151</span> προέκταση «Half» γκρι, 25 θέσεων <i>25 compartements extender* Half; gray</i> (8,7x8,7 cm) pack: 12
	<b>92.00017</b> <span style="float: right;">30GE1151</span> προέκταση «Full» γκρι, 30 θέσεων <i>30 compartements extender; gray</i> (7,94x7,94 cm) pack: 12
	<b>92.00024</b> <span style="float: right;">30GE2151</span> προέκταση «Half» γκρι, 30 θέσεων <i>30 compartements extender* Half; gray</i> (7,94x7,94 cm) pack: 12

	<b>92.00021</b> <span style="float: right;">36E1151</span> προέκταση «Full» γκρι, 36 θέσεων <i>36 compartements extender; gray</i> (7,3x7,3 cm) pack: 12
	<b>92.00028</b> <span style="float: right;">36E2151</span> προέκταση «Half» γκρι, 36 θέσεων <i>36 compartements extender* Half; gray</i> (7,3x7,3 cm) pack: 12
	<b>92.00022</b> <span style="float: right;">49E1151</span> προέκταση «Full» γκρι, 49 θέσεων <i>49 compartements extender; gray</i> (6,2x6,2 cm) pack: 12
	<b>92.00029</b> <span style="float: right;">49E2151</span> προέκταση «Half» γκρι, 49 θέσεων <i>49 compartements extender* Half; gray</i> (6,2x6,2 cm) pack: 12
	προεκτάσεις «Half drop» γκρι <i>half drop extenders; gray</i> <b>92.00037</b> <span style="float: right;">20GE5151</span> 20 θέσεων   <i>20 compartements</i> (9,8x9,8 cm) pack: 12
	<b>92.00038</b> <span style="float: right;">25E5151</span> 25 θέσεων   <i>25 compartements</i> (8,9x8,9 cm) pack: 12
	<b>92.00039</b> <span style="float: right;">36E5151</span> 36 θέσεων   <i>36 compartements</i> (7,3x7,3 cm) pack: 12





*συνεδριακός εξοπλισμός | conference*

*Burgess*.....508-519

*lobby & room service*

*Wanzl*.....520-526

*Dorelan*.....527

*Caddie*.....528-539

*κοδωνάκια διαδρόμου*.....540

*σταχτοδοχεία δαπέδου*.....541

*waste management*.....541-543

*κάδοι πενιάδ, κάδοι μεταδόγκοι, κάδοι κήπου*

*έπιπλα εξωτερικού χώρου*.....544-549



*συνεδριακός εξοπλισμός  
υποδοχή - καθαρισμός -  
έπιπλα εξωτερικών χώρων*



*conference  
lobby & room service -  
waste management -  
outdoor furniture*

# burgess furniture

Ο οίκος BURGESS Αγγλίας κατασκευάζει έπιπλα συνεδρίων και δεξιώσεων για τον ξενοδοχειακό τομέα πάνω από 60 χρόνια! Η επιτυχία του βασίζεται στην ποιοτική βρετανική δεξιοτεχνία που συνδυάζει εξαιρετικό σχεδιασμό και αξιοπιστία. Το εργοστάσιο εδρεύει στη Μεγάλη Βρετανία και κάθε προϊόν κατασκευάζεται με προσοχή στη λεπτομέρεια, επενδύοντας πάνω σε άρτια εκπαιδευμένο προσωπικό για μέγιστα αποτελέσματα.

Προσφέροντας μια μεγάλη γκάμα προϊόντων όπως τραπέζια, καρέκλες και αξεσουάρ, ο οίκος BURGESS μεταιρέπει τους πιο ήπιους χώρους σε λειτουργικούς δίνοντας τάση και στυλ!

Χώροι συσκέψεων - Συνέδρια - Αίθουσες συνεδριάσεων - Εκδηλώσεις δεξιώσεων και Υπνοδωμάτια αναδεικνύονται άψογα σε μέσα από το όνομα BURGESS που αποδεικνύει εγγύηση υψηλής ποιότητας!

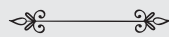

*Burgess has provided furniture for the hospitality industry for over 60 years! Its success is built upon quality British craftsmanship and heritage that combines excellent design and reliability. The factory is based in Great Britain and each product is manufactured with attention to detail, investing in well-trained staff for maximum results.*

*Offering a wide range of products such as tables, chairs and accessories, BURGESS transforms the softest spaces into functional ones, giving trend and style!*

*Meeting spaces - Conferences - Boardrooms - Events - Dining - Bedrooms and Casual spaces are highlighted under the name of BURGESS which is a guarantee of high quality!*



Το νέο σημείο αναφοράς στο σύγχρονο συνεδριακό & ξενοδοχειακό εξοπλισμό καθισμάτων. Κατέχει βραβείο εργονομίας από τον οργανισμό F.I.R.A. (Furniture Industry Research Association).

«Orvia»

*The new benchmark in contemporary banquet and conference chairs Orvia has achieved the FIRA Ergonomics Excellence Award.*

#### Χαρακτηριστικά

- 5 μοντέρνα σχέδια.
- Εύκαμπτη πλάτη για οσφυϊκή στήριξη και άνεση.
- Διαθέτει εργονομικά σχεδιασμένο μαξιλάρι καθίσματος με φαρδύτερη διάσταση 45εκ.
- Ασύμμετρος σκελετός αλουμινίου που συνδυάζει την αντοχή με τη λεπτή κομψότητα.
- Διατίθεται σειρά επιλογών χρωμάτων σκελετού και υφασμάτων.
- Δυνατότητα στοίβαξης.

#### Πρόσθετες επιλογές

- Διακριτική λαβή στην κορυφή της πλάτης, διαθέσιμη σε όλα τα μοντέλα.
- Μοντέρνα μπράτσα με κομψό σχεδιασμό.

#### Αξεσουάρ

- Συρόμενη ράγα σύνδεσης καθισμάτων με προαιρετική αρίθμηση.
- Αποσπώμενο περιστροφικό τραπεζάκι καθίσματος.



45x63 cm | 47/91 cm

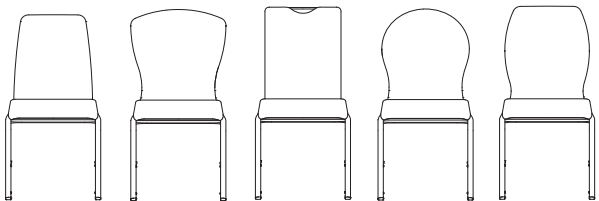

Ο σχεδιασμός του ενσωματώνει την προηγμένη τεχνολογία καθισμάτων ProBax® η οποία φέρνει ένα νέο επίπεδο άνεσης, ιδανικό για εκδηλώσεις και χώρους συνεδρίων. Κατέχει βραβείο καινοτομίας από τον οργανισμό F.I.R.A. (Furniture Industry Research Association)

*Mendola brings you a new level of comfort. It's design incorporates ProBax® Advanced Seating Technology, which has been awarded the FIRA Innovation Award.*

«Mendola»

#### Χαρακτηριστικά

- Προηγμένη τεχνολογία καθισμάτων ProBax® για εργονομική υποστήριξη.
- Σκελετός αλουμινίου με ελαφριά τριγωνική προεξοχή.
- Διατίθεται σειρά επιλογών χρωμάτων σκελετού και υφασμάτων.
- Δυνατότητα στοίβαξης.

#### Πρόσθετες επιλογές

- Χωνευτή λαβή στο πίσω μέρος της πλάτης.
- Μοντέρνα μπράτσα με κομψό σχεδιασμό.

#### Αξεσουάρ

- Συρόμενη ράγα σύνδεσης καθισμάτων με προαιρετική αρίθμηση.
- Αποσπώμενο περιστροφικό τραπεζάκι καθίσματος.



60x57 cm | 46/88 cm

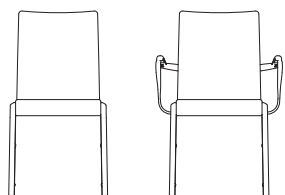

## «Evosa»

Με μινιμαλιστικό στυλ που συμπληρώνει κάθε δωμάτιο, η Evosa είναι η τέλεια καρέκλα για τους πιο διακεκριμένους χώρους. Το λεπτό επιχρωμωμένο ατσάλινο πλαίσιο και η επιλογή πλεκτού υφάσματος (knitted mesh) ή επένδυσης πλάτης δημιουργούν μια μοντέρνα καρέκλα εξαιρετικού σχεδιασμού και ποιότητας.

*Minimalist styling to complement any room, a modern chair of outstanding design and quality. Evosa is the perfect chair for the most prestigious venues.*



46x56 cm | 47/87 cm

### Χαρακτηριστικά

- Κομψή λεπτομέρεια γωνίας ποδιού.
- Επιλογή επενδεδυμένης πλάτης ή καινοτόμου πλεκτού υφάσματος (knitted mesh).
- Κάθισμα με ενσωματωμένο πλέγμα για άνεση.
- Σκελετός από επιχρωμωμένο ατσάλι.
- Δυνατότητα στοιβαξης.

### Πρόσθετες επιλογές

- Διατίθεται και σε βιομηχανικό φινίρισμα σκελετού.
- Κομψό μαύρο μπράτσο.

### Αξεσουάρ

- Σύνδεση καθισμάτων με κλιπ.

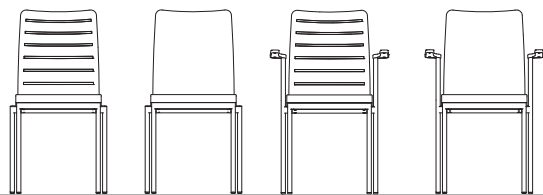

510

## «Sentrum»

Σύγχρονος σχεδιασμός και εξαιρετική άνεση. Το κάθισμα με ενσωματωμένο πλέγμα σε συνδυασμό με το ατσάλινο "γεφυρωτό" (cantilever) πλαίσιο του σκελετού, προσδίδει στυλ σε κάθε επαγγελματικό χώρο.

*Sentrum provides superb comfort with its built-in webbed seat and innovative knitted stretch mesh fabric. Contemporary chairs to suit any space.*



47x60 cm | 48,5/96 cm

### Χαρακτηριστικά

- Καινοτόμο πλεκτό ύφασμα σε μαύρο χρώμα ως βασική επιλογή.
- Σκελετός από επιχρωμωμένο ατσάλι.
- Κάθισμα με ενσωματωμένο πλέγμα για άνεση.
- Δυνατότητα στοιβαξης.

### Πρόσθετες επιλογές

- Γυαλισμένοι βραχιόνες από αλουμίνιο με ένθετο από ξύλο.

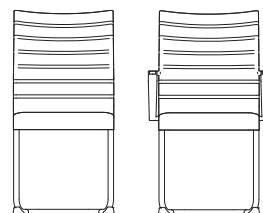

Μια μοντέρνα ματιά σε ένα κλασικό σχέδιο καθίσματος που τοποθετείται άψογα τόσο σε συνεδριακό χώρο όσο και σε χώρο δεξιώσεων.

*Vario is a modern classic design that complements both conference and banquet interiors.*

«Vario-Allday™»

#### Χαρακτηριστικά

- 5 εναλλακτικά σχέδια.
- Εύκαμπτη πλάτη για οσφυϊκή στήριξη και άνεση.
- Μοναδικός κυρτός σκελετός αλουμινίου.
- Διατίθεται σειρά επιλογών χρωμάτων σκελετού και υφασμάτων.
- Δυνατότητα στοίβαξης.

#### Πρόσθετες επιλογές

- Διακριτική λαβή στην κορυφή της πλάτης, διαθέσιμη σε όλα τα μοντέλα.
- Κλασικά μπράτσα.

#### Αξεσουάρ

- Συρόμενη ράγα σύνδεσης καθισμάτων με προαιρετική αρίθμηση.
- Αποσπώμενο τραπεζάκι καθίσματος.



43x63,5 cm | 47x90,5 cm

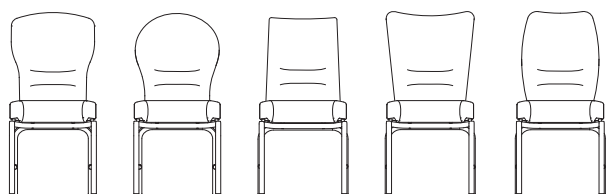

Αυτή η ξεχωριστή συλλογή αποτελεί το πρώτο βραβευμένο φάσμα καθισμάτων που συμπληρώνει τον διπλό ρόλο μιας ολόημερης καρέκλας συνεδρίου και μιας καρέκλας δεξιώσεων. Ο ιδιαίτερος σχεδιασμός του σκελετού αλουμινίου τονίζει τις κομψές γραμμές του συνδυάζοντας μαξιλάρι καθίσματος εξαιρετικής άνεσης πλάτους 45 εκ. Είναι το πρώτο κάθισμα που κέρδισε βραβείο εργονομίας από τον οργανισμό F.I.R.A. (Furniture Industry Research Association)

*This distinctive collection features BURGESS original Siena aluminium extrusion which accentuates the elegant lines of the chairs. The range incorporates the Allday™ Comfort Plus seat cushion. Siena-Allday™ was the first hospitably chair to achieve the FIRA ergonomics excellences award.*

«Siena-Allday™»

#### Χαρακτηριστικά

- 6 εναλλακτικά σχέδια.
- Εργονομικό κάθισμα Allday™ Comfort Plus.
- Πλάτη κατάλληλα σχεδιασμένη για οσφυϊκή στήριξη και άνεση με λαβή στην κορυφή της.
- Διατίθεται σειρά επιλογών χρωμάτων σκελετού και υφασμάτων.
- Δυνατότητα στοίβαξης.

#### Πρόσθετες επιλογές

- Κλασικά μπράτσα.

#### Αξεσουάρ

- Συρόμενη ράγα σύνδεσης καθισμάτων με προαιρετική αρίθμηση.
- Πλαστική σύνδεση καθισμάτων σε χρυσό, ασήμι και μαύρο.
- Αποσπώμενο τραπεζάκι καθίσματος.



45x63 cm | 44,5/93 cm

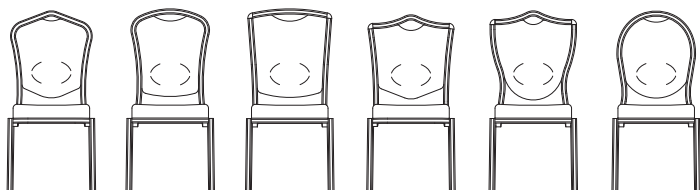

## «Turini»

Ένα αληθινά διαχρονικό κάθισμα που αντέχει στη δοκιμασία του χρόνου. Το κλασικό του στυλ του διαθέτει πλάτος καθίσματος 42 εκ. σχεδιασμένο για μεγιστοποίηση της χωρητικότητας δωματίου.

*Turini is a true timeless classic. The 'original' Turini has stood the test of time, its classic styling comes with a waterfall shaped seat and at 42cm wide, it is designed to maximise room capacity.*



42x58 cm | 44,5/86 cm

### Χαρακτηριστικά

- 10 εναλλακτικά σχέδια.
- Ανατομικό μαξιλάρι καθίσματος 42 εκ.
- Τετράγωνος σκελετός αλουμινίου.
- Διατίθεται σειρά επιλογών χρωμάτων σκελετού και υφασμάτων.
- Δυνατότητα στοιβάζης.

### Πρόσθετες επιλογές

- Κλασικά μπράτσα.
- Διαθέσιμο πλάτος καθίσματος 45 εκ.

### Αξεσουάρ

- Συρόμενη ράγα σύνδεσης καθισμάτων με προαιρετική αρίθμηση.
- Πλαστική σύνδεση καθισμάτων σε χρυσό, ασημί και μαύρο.
- Αποσπώμενο τραπέζακι καθίσματος.

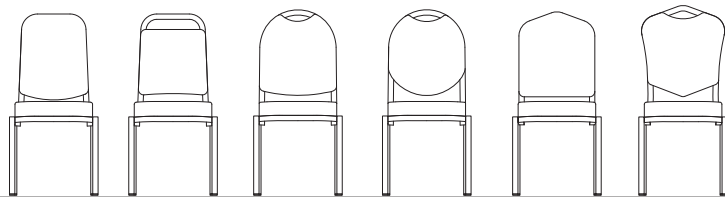

512

## καρότσια μεταφοράς καθισμάτων



CTH/1  
26x66 cm | 125 cm



CTH/4  
82x66 cm | 110 cm

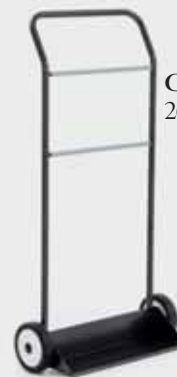

CTH/5  
26x66 cm | 125 cm



CTH/6  
84x66 cm | 105,5 cm



CTH/7  
26x66 cm | 113 cm



CTH/1  
80x65,5 cm | 125 cm

Η συλλογή A-Fold συνδυάζει εξαιρετικό σχεδιασμό με δομική σταθερότητα. Γιατί να επιλέξετε την κομψότητα σε σχέση με την πρακτικότητα, όταν μπορείτε έχετε και τα δύο σε ένα εξαιρετικά κομψό πτυσσόμενο τραπέζι; Να είσαι τολμηρός. Να είσαι A-Fold®.

*The A-Fold collection blends great design with structural rigidity. Why pick elegance over practicality when you can have both in one ultra-stylish folding table? Be bold. Go A-Fold®.*

#### Χαρακτηριστικά

- Σκελετός από ατσάλι με επίστρωση μαγνητικής βαφής (powder coated).
- Διαθέσιμο ύψος 76 cm.
- Αναδιπλούμενα πόδια για εύκολη αποθήκευση.
- Κλείδωμα ασφαλείας μηχανισμού αναδίπλωσης ώστε να είναι ασφαλής κατά τη χρήση.
- Διακριτικά κλιπ σύνδεσης τραπεζιών ως βασική επιλογή.
- Επιτραπέζιες επιφάνειες HPL σε μεγάλη επιλογή χρωμάτων με ανθεκτικό άκρο T-Barb.
- Μεγάλη ποικιλία διαθέσιμων σχημάτων και μεγεθών: ορθογώνια, στρογγυλά, D-άκρα και γωνίες.
- Διατίθεται μεγάλη γκάμα φινιρισμάτων σκελετού και επιφανειών.

#### Πρόσθετες επιλογές

- Διατίθεται και σε βιομηχανικό φινίρισμα σκελετού.
- Δυνατότητα σκελετού με ξύλινα πόδια.
- Αποσπώμενα μαγνητικά πλαίσια ποδιάς αλουμινίου (modesty panel) με επίστρωση μαγνητικής βαφής (powder coated).



Ένα ανώτερο πτυσσόμενο σύστημα τραπεζιού που εκπληρώνει τις πιο υψηλές απαιτήσεις των επαγγελματιών συνεδριακού χώρου. Τα τραπέζια System-C είναι ιδανικά για οποιαδήποτε αίθουσα συσκέψεων αφού μπορούν να τοποθετηθούν εξίσου σε σύγχρονους και παραδοσιακούς χώρους.

*A superior folding table system to fulfill conference managers' requirements. System-C is perfect for any meeting room since they are equally placed in contemporary and traditional syndicate meeting rooms.*

#### Χαρακτηριστικά

- Σκελετός από επιχρωμιωμένο ατσάλι ή ατσάλι με επίστρωση μαγνητικής βαφής (powder coated).
- Διαθέσιμο ύψος 76 cm.
- Αναδιπλούμενα πόδια για εύκολη αποθήκευση.
- Κλείδωμα ασφαλείας μηχανισμού αναδίπλωσης ώστε να είναι ασφαλής κατά τη χρήση.
- Διακριτικά κλιπ σύνδεσης τραπεζιών ως βασική επιλογή.
- Επιτραπέζιες επιφάνειες HPL σε μεγάλη επιλογή χρωμάτων με ανθεκτικό άκρο T-Barb ή σκληρό ξύλο.
- Μεγάλη ποικιλία διαθέσιμων σχημάτων και μεγεθών: ορθογώνια, D-άκρα και γωνίες.

#### Πρόσθετες επιλογές

- Αποσπώμενο πλαίσιο ποδιάς σε μεγάλη επιλογή χρωμάτων HPL με ανθεκτικό άκρο T-Barb.
- Πτυσσόμενα πλαίσια ποδιάς αλουμινίου (modesty panel) με επίστρωση μαγνητικής βαφής (powder coated).





## «Configure-8»

Κομψό, λεπτό και ελαφρύ το Configure-8 προσφέρει μια εκπληκτικά ανώτερη εμφάνιση. Κατασκευασμένο από ανοδιωμένο αλουμίνιο αυτό το κομψό, λεπτό και ελαφρύ τραπέζι θα φαίνεται υπέροχο σε οποιοδήποτε χώρο διάσκεψης ή αίθουσας συνεδριάσεων.

*The Configure-8 table range offers a stunningly superior look. Designed using anodised aluminium this sleek, slim and lightweight table will look great in any meeting, conference or boardroom.*



### Χαρακτηριστικά

- Σκελετός από ανοδιωμένο αλουμίνιο
- Διαθέσιμο ύψος 76 cm
- Αναδιπλούμενα ρυθμιζόμενα πόδια για εύκολη αποθήκευση (τα ρυθμιζόμενα πόδια σας επιτρέπουν να έχετε το σωστό επίπεδο σε οποιαδήποτε κατάσταση δαπέδου)
- Κλείδωμα ασφαλείας μηχανισμού αναδίπλωσης ώστε να είναι ασφαλής κατά τη χρήση
- Διακριτικά κλιπ σύνδεσης τραπεζιών ως βασική επιλογή.

- Επιτραπέζιες επιφάνειες HPL σε μεγάλη επιλογή χρωμάτων με ανθεκτικό άκρο T-Barb
- Μεγάλη ποικιλία διαθέσιμων σχημάτων και μεγεθών: ορθογώνια, D-άκρα και γωνίες
- Δυνατότητα να υπάρχει ίδιο φινιρίσμα ποδιού (μεσαία κολώνα) με αυτό της επιφάνειας

### Πρόσθετες επιλογές

- Αποσπώμενο πλαίσιο ποδιάς σε μεγάλη επιλογή χρωμάτων HPL με ανθεκτικό άκρο T-Barb
- Δυνατότητα σκελετού με επίστρωση μαγνητικής βαφής (powder coated) σε μεγάλη επιλογή χρωμάτων

514

## «Slimfold™»

Η τελευταία γενιά τραπεζιών δεξιώσεων. Η σειρά Slimfold™ διαθέτει πλενόμενες επιφάνειες τσόχας (nylon flock) που μειώνουν το θόρυβο και την ολίσθηση του υφάσματος, πρόσθετα έχει τελείωμα από αλουμίνιο για μέγιστη προστασία. Με στιβαρό σκελετό από ατσάλι και με μια κομψή και σύγχρονη εμφάνιση η σειρά Slimfold™ είναι μια ιδανική επιλογή για δεξιώσεις και εκδηλώσεις.

*The latest generation of banquet tables. Slimfold™ tables come with a washable grey flock coated top, which reduces noise and cloth slippage. They also have aluminium edge for maximum protection. The robust steel frame combined with the sleek and contemporary look makes Slimfold™ table an ideal choice for banquets and dining events.*



### Χαρακτηριστικά

- Σκελετός από ατσάλι σε χρώμα pewter hammer ή ατσάλι με επίστρωση μαγνητικής βαφής (powder coated).
- Διαθέσιμα ύψη 72, 74, 76 cm.
- Αναδιπλούμενα πόδια για εύκολη αποθήκευση.
- Κλείδωμα ασφαλείας μηχανισμού αναδίπλωσης ώστε να είναι ασφαλής κατά τη χρήση.
- Πλενόμενες επιφάνειες τσόχας (nylon flock) με άκρο από αλουμίνιο.

- Μεγάλη ποικιλία διαθέσιμων σχημάτων και μεγεθών: στρογγυλά, τετράγωνα, ορθογώνια, οβαλ, 72° Segment (κρουασάν), D-άκρα και γωνίες.

### Πρόσθετες επιλογές

- Επιτραπέζιες επιφάνειες HPL σε μεγάλη επιλογή χρωμάτων με ανθεκτικό άκρο T-Barb.
- Προσαρμοσμένα μεγέθη & διαμορφώσεις ποδιών T-bar διαθέσιμα κατόπιν αιτήματος.

*A-Fold®*, *Configure-8* and *System-C* trolleys



*Slimfold™* trolleys



Image courtesy of Hilton Amsterdam Airport Schiphol - Meeting Room 15 & 16

## «Buffet cube»

Ένα εξαιρετικά ευέλικτο σύστημα μπουφέ με αναδιπλούμενα πλαίσια σε διαφορετικά ύψη, που σας επιτρέπει να δημιουργήσετε ένα πολυεπίπεδο μπουφέ.

*Buffet Cube is a highly flexible buffet display stand system. The folding underframes with a variety of different heights will allow you to create an interesting buffet landscape to wow your guests.*



### Χαρακτηριστικά

- Σκελετός από επιχρωμωμένο ατσάλι ή ατσάλι με επίστρωση μαγνητικής βαφής (powder coated).
- Διαθέσιμα ύψη σκελετού 60, 75, 90, 105 και 120cm.
- Γρήγορη και εύκολη αναδίπλωση πλαισίου.
- Αποσπώμενες επιτραπέζιες επιφάνειες για ευκολία αποθήκευσης.
- Διαφανείς γυάλινες τετράγωνες επιτραπέζιες επιφάνειες (μόνο 75cm ή 90 cm).

- Επιτραπέζιες επιφάνειες HPL σε μεγάλη επιλογή χρωμάτων με με άκρη ABS.
- Διαθέσιμα καρότσια μεταφοράς πλαισίων & επιφανειών.

### Αξεσουάρ

- Μικρότερα τετράγωνα πλαίσια ανύψωσης με γυαλί διαστάσεων 20, 30 και 40 cm.



516

## «Trans-Pose®»

Ένα μοντέρνο, ευέλικτο τραπέζι. Το σύστημα τραπέζιού Trans-Pose® αποτελείται από ένα πολυμορφικό πλαίσιο σκελετού το οποίο προσφέρει μια ευέλικτη λύση για υψηλά αλλά και χαμηλά τραπέζια.

*A modern flexible table solution. Burgess Trans-Pose® consists of interchangeable frames, cradles and tops to provide a versatile table solution.*



### Χαρακτηριστικά

- Πλαίσιο σωλήνα από μαλακό χάλυβα.
- Επιτραπέζιες επιφάνειες HPL σε μεγάλη επιλογή χρωμάτων.
- Αναδιπλούμενα πόδια για εύκολη αποθήκευση.
- Δυνατότητα εύκολης στοιβάζης μόλις διαχωριστούν τα πλαίσια, οι βάσεις και οι επιτραπέζιες επιφάνειες.
- Διαθέσιμο καρότσι μεταφοράς πλαισίων & επιφανειών.

### Πρόσθετες επιλογές

- Δυνατότητα τοποθέτησης καθίσματος μαξιλαριού για μετατροπή σε κάθισμα πάγκου



## «Tabou»

Η συλλογή Tabou περιλαμβάνει μια γκάμα από τραπέζια για κάθε περίπτωση. Τραπέζια κοκτέιλ, εστιατορίου και καφέ αποκτούν μια μοντέρνα και σύγχρονη εμφάνιση για οποιαδήποτε επίσημη ή ανεπίσημη συγκέντρωση.

*The Tabou range of cocktail, restaurant and occasional tables offers a modern and contemporary look to any formal or informal gathering.*

### Χαρακτηριστικά

- Στρογγυλές ή τετράγωνες επιτραπέζιες επιφάνειες.
- Σταθερές, αναδιπλούμενες ή ρυθμιζόμενου ύψους βάσεις τραπέζιων (ανάλογα το μοντέλο).
- Επιτραπέζιες επιφάνειες HPL σε μεγάλη επιλογή χρωμάτων με άκρη ABS.



Η συλλογή Nestr είναι μια σειρά από τραπέζια παρουσίασης ιδανικά για χρήση μπουφέ. Με 3 επιλογές ύψους, τα τραπέζια φωλιάζουν άψογα μαζί εξοικονομώντας χώρο αποθήκευσης. Ανακατέψτε πολλά ύψη, φινιρίσματα και σχήματα για να δημιουργήσετε μια εντυπωσιακή παρουσίαση μπουφέ τέλεια για το χώρο σας.

*Nestr is a range of presentation tables ideal for use with buffets, displays and more. 3 height options seamlessly nest together to reduce storage footprint. Mix multiple heights, finishes and shapes to create a striking display that's perfect for your space.*

### Χαρακτηριστικά

- Σκελετός από ατσάλι με επίστρωση μαγνητικής βαφής (powder coated).
- Επιτραπέζιες επιφάνειες HPL σε μεγάλη επιλογή χρωμάτων με με άκρη ABS.
- 3 διαφορετικά ύψη 72, 79 και 86 cm.



## «Centrefold platform»

Η πλατφόρμα Centrefold είναι φορητή αναδιπλούμενη εξέδρα που περιλαμβάνει πολλά χαρακτηριστικά για εύκολη λειτουργία. Είναι ελαφριά αλλά εξαιρετικά ισχυρή και ανθεκτική καθώς είναι κατασκευασμένη από ατσάλι και αλουμίνιο. Διατίθεται σε δυο μεγέθη 244x122cm ή 244x183cm διπλού 40-60cm ή 60-80cm ή μονού 40cm ή 60cm ύψους.

Όλες οι πλατφόρμες Centrefold μπορούν να επενδυθούν με βινυλικό αντιολισθητικό πάτωμα ή μοκέτα της αρεσκείας σας. Περιμετρικά μπορούν να καλυφθούν με skirting (χρώμα επιλογής σας), ενώ υπάρχει μια πλήρης γκάμα αξεσουάρ (σκαλοπάτια, κάγκελα, σύνδεσμοι ένωσης κ.λπ.) για να συνθέσετε γρήγορα και με ασφάλεια τον υπερυψωμένο χώρο που χρειάζεστε.

*The Centrefold Platform is a portable staging system which includes many features for easy operation. The stage is lightweight but extremely strong and durable since it is made out of steel and aluminium. Available in two sizes 244x122cm or 244x183cm dual 40-60cm or 60-80cm or single 40cm or 60cm height.*

*All Centrefold platforms can have either a vinyl non-slip flooring or carpet of your choice. Perimeters can be covered with skirting (color of your choice) while there is a full range of accessories (stairs, railings, joints, etc.) to compose quickly and safely the elevated space you need.*



518

## «Stand Smart»

Το αναλόγιο Stand Smart θέτει το νέο υψηλό πρότυπο για τις διαλέξεις. Κατασκευασμένο από σκελετό αλουμινίου με δυνατότητα επιλογής φινιρίσματος επιφάνειας HPL σε μεγάλη επιλογή χρωμάτων, γίνεται ιδανικό για αίθουσες διαλέξεων και συνέδρια.

*Stand Smart sets the new high standard for lecterns. Upright infill panels of HPL are set into an aluminium frame that can be customised in a variety of finishes makes it ideal for lecture halls and conferences.*



### Διαθέτει:

- Συνδεσιμότητα USB / USB-C.
- Εύκαμπτο φως swan neck LED.
- Ενσωματωμένο ράφι.
- Δυνατότητα διαχείρισης καλωδίων.
- Ρυθμιζόμενα πόδια για σωστό επίπεδο σε οποιαδήποτε κατάσταση δαπέδου.

### Πρόσθετες επιλογές

- Τοποθέτηση λογοτύπου.
- Δυνατότητα επιλογής ενσωματωμένων πριζών και HDMI συνδεσιμότητα.
- Θήκη ποτηριού.

## Room service trolley

Πρακτικό. Εύκαμπτο. Λειτουργικό ... ένα προϊόν Burgess που οφείλει να έχει κάθε υπηρεσία δωματίου. Προσφέρει απόλυτη ευελιξία τόσο στο προσωπικό όσο και στους επισκέπτες του ξενοδοχείου. Η ευκολία χρήσης και η κορυφαία μοντέρνα εμφάνιση το καθιστά απαραίτητο για την ιδανικότερη εμπειρία φαγητού υπηρεσίας δωματίου.

*Practical. Flexible. Functional... a Burgess must-have. The Burgess Room Service Trolley offers hotel staff & guests ultimate flexibility, ease of use and a modern sharp look. It is an F&B essential for the best in-room dining experience.*

### Χαρακτηριστικά

- 3 διαφορετικές επιλογές: στρογγυλό, τετράγωνο και οβάλ
- Ανοδιωμένο πλαίσιο αλουμινίου
- Φινίρισμα επιφάνειας σε Wenge 7510 χρώμα ή χρώμα ξύλου καρυδιάς
- Πτυσσόμενα περύγια
- Περιστροφικός μηχανισμός αναστροφής
- Ομαλοί αθόρυβοι τροχοί
- Φιλοξενεί μέχρι 2 θερμοθάμους τροφίμων (S0300: ηλεκτρικός θερμοθάλαμος - S0301: πλήρως μονωμένος - διατηρεί τη θερμοκρασία για τουλάχιστον 1 ώρα) χαρακτηριστικά θερμοθαλάμων: κατασκευή αλουμινίου, αφαιρούμενα ράφια, θερμοστατικά ελεγχόμενος, διατίθεται με διεθνή καλώδια τροφοδοσίας, 220V ή 240V)



## Καθορίστε το χώρο σας!

Το έμπειρο τμήμα σχεδιασμού του οίκου BURGESS προσφέρει τη δυνατότητα παρουσίασης του χώρου σας, απεικονισμένο στις διατάξεις που επιθυμείτε με τα κατάλληλα BURGESS προϊόντα.

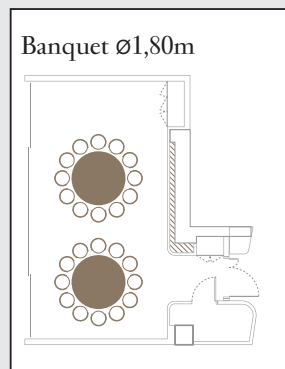
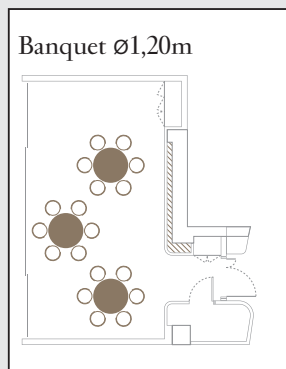
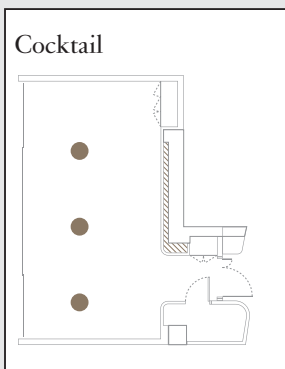
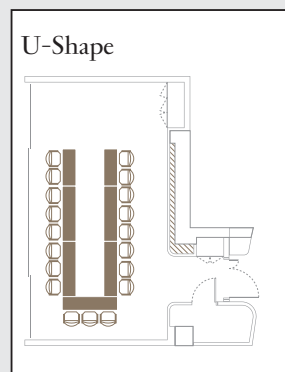
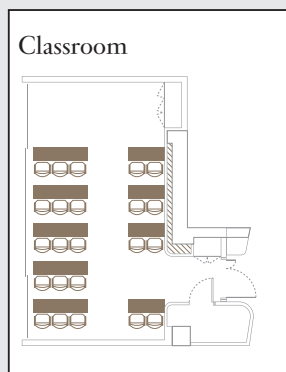
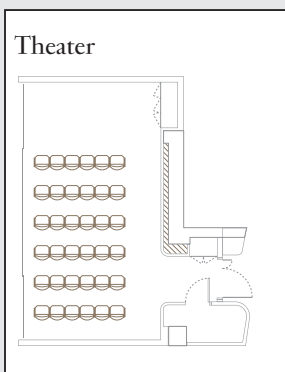

## Define your space!

Our CAD layout service is available to all Burgess customers to assist with product selection and specification.

### Διατάξεις αίθουσας εκδηλώσεων:

- Θεάτρου (Theater)
- Διδασκαλίας (Classroom)
- Συνεδριακό σε σχήμα «U» ή τετράγωνο (U or square shape)
- Αίθουσα συνεδριάσεων (Boardroom)
- Δεξιώσεων (Banquet)
- Cocktail



# wanzl

*Στη Wanzl ξέρουμε τι θα θέσει ο κόσμος αύριο!*

*Ο στόχος: απόλυτα ικανοποιημένοι πελάτες!*

*Ο οίκος κατασκευής καροτσιών Wanzl Γερμανίας εξειδικεύεται στην κατασκευή καροτσιών για ξενοδοχεία, αεροδρόμια και καταστήματα.*

*Με 13 μονάδες παραγωγής, πάνω από 5.000 υπαλλήλους ανα την υφήλιο και ένα εξειδικευμένο κέντρο Έρευνας και Ανάπτυξης (R&D) στη Γερμανία, δικαίως θεωρείται ο κορυφαίος κατασκευαστής καροτσιών στον κόσμο!*

*Ο σχεδιασμός με γνώμονα την απροβλεπτή σκληρή χρήση και η εφαρμογή σύγχρονης τεχνολογίας με κορυφαία υλικά κατασκευής, εξασφαλίζουν ότι τα καρότσια του οίκου Wanzl θα εξυπηρετούν εσάς και τους πελάτες σας για πάρα πολλά χρόνια!*

*At Wanzl we know what people will want tomorrow!*

*The aim: perfectly satisfied customers!*

*Wanzl is a German manufacturer which specializes in trolley production for hotels, airports and shops.*

*With a 13 production units, over 5,000 employees worldwide and a specialized Research and Development center in Germany, Wanzl is rightly considered the leading trolley manufacturer in the world!*

*Using cutting-edge production, state-of-the-art technology and the best materials we ensure that Wanzl trolleys will serve you and your customers for many years to come!*

## τρόχει αποσκευών «GS-Trend»

Καινοτομία και ποιότητα συνδυασμένα σε έναν κομψό σχεδιασμό!

*Innovation and quality packaged in an elegant design*

### Κύρια χαρακτηριστικά

- Ατσάλινος σκελετός στρογγυλού σωλήνα με ράγα παλτών.
- Ανθεκτική βάση με φρένο, αντέχει βάρος 200kg, επενδεδυμένη με χαλί σε γκρι χρώμα, περιμετρική προστασία σε κάθε γωνία του καροτσιού για αποφυγή τραυματισμών των τοίχων σας (All-round bumper profile).
- Φινίρισμα σκελετού: επίστρωση ηλεκτρολυτικής βαφής (electro-polished).
- Τροχοί: 2 περιστρεφόμενες ρόδες και 2 σταθερές διαμέτρου 160 mm με αθόρυβο καουτσούκ πέλημα.

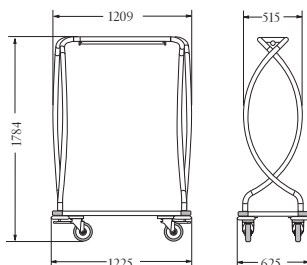

05.59778.31-V007  
«GS-Trend»  
122,5x62,5 cm | 178,4 cm

Η ευέλικτη και συμπαγής λύση στα τρόχει αποσκευών!

*The versatile and compact solution for group luggage!*

### Κύρια χαρακτηριστικά

- Ατσάλινος σκελετός στρογγυλού σωλήνα με ράγα παλτών.
- Ανθεκτική ατσάλινη βάση με δυνατότητα τοποθέτησης ξύλινης επιφάνειας
- Πλαστικά προφίλ τοποθετημένα στο πλάι στις όρθιες ράβδους
- Φινίρισμα σκελετού: επίστρωση επιχρωμιωμένου χάλυβα, υψηλής στιλπνότητας
- Τροχοί: 2 περιστρεφόμενες ρόδες και 2 σταθερές διαμέτρου 125 mm με αθόρυβο καουτσούκ πέλημα

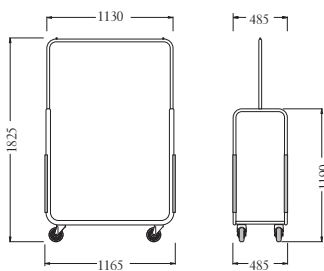

## τρόχει αποσκευών «GS-Group»

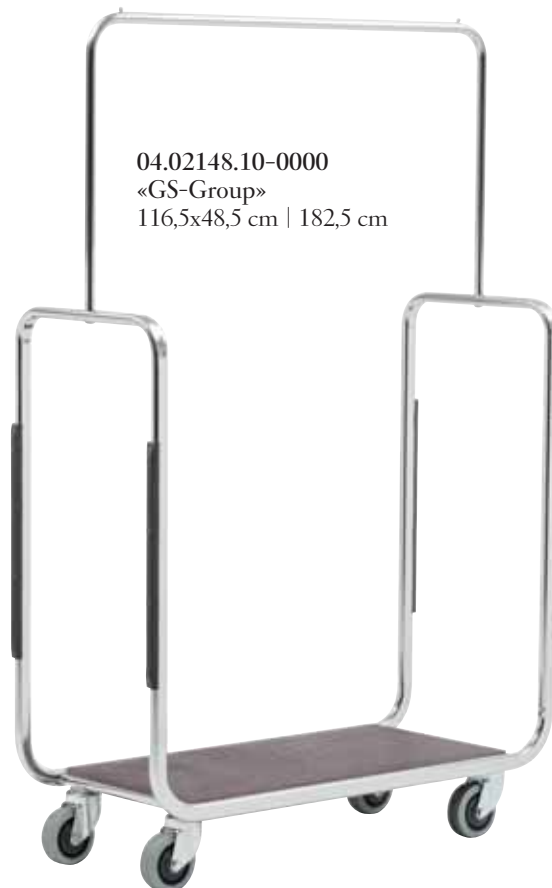

04.02148.10-0000  
«GS-Group»  
116,5x48,5 cm | 182,5 cm



## «GS-Compact» τροχίει αποσκευών

GS-Compact 600 A  
«GS-Compact»  
85x50 cm | 124 cm



GS-Compact 800 R  
«GS-Compact»  
103x50 cm | 124 cm

Το πρακτικό καρότσι αποσκευών με αναδιπλούμενη βάση για εξοικονόμηση χώρου!

*The practical luggage collection trolley! Saves lots of space with its fold-out loading areas.*

### Κύρια χαρακτηριστικά

- Ατσάλινος σκελετός στρογγυλού σωλήνα με αναδιπλούμενη βάση.
- Επενδεδυμένο με αντιολισθητικό χαλί, κόκκινο χρώμα.
- Διαθέτει πρόσθετο στήριγμα στην πλάτη για να μπορεί να τοποθετείται οριζόντια.
- Φινίρισμα σκελετού: ανοξείδωτο ατσάλι.
- Τροχοί: 2 ανάγλυφες φουσκωτές ρόδες διαμέτρου 260 mm.

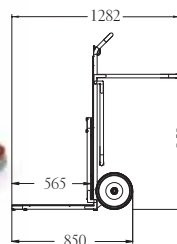

GS-Compact 600 A

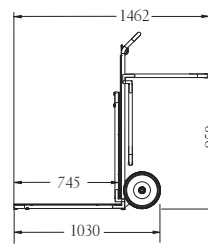

GS-Compact 800 R

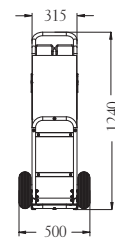

522

## «GR-Slim» τροχήλατη κρεμάστρα



04.02713.95-000  
«GR-Slim»  
189x60 cm | 189,5 cm

Ένα φίνο κομψό σχέδιο με αξεπέραστη λειτουργία!

*A pared-down form with unsurpassed functioning!*

### Κύρια χαρακτηριστικά

- Ατσάλινος σκελετός κωνικού σωλήνα, με ράγα παλτών και πρακτικό ράφι καπέλων.
- Δυνατότητα στοίβαξης για εξοικονόμηση χώρου.
- Φινίρισμα σκελετού: επίστρωση μαγνητικής βαφής (powder coated) γκρι τιτανίου και τα υπόλοιπα μέρη επχρωμωμένο ατσάλι.
- Τροχοί: 4 περιστρεφόμενες ρόδες (δυο με φρένο & δυο χωρίς) διαμέτρου 125 mm ελαστικό πέλμα με πλαστικούς δακτύλιους.

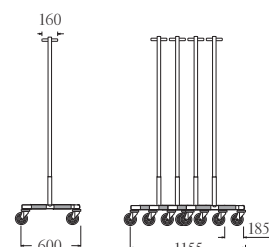
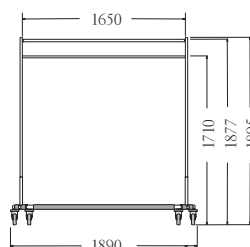

WANZI

## τρόχει bar-service | Minibar filling trolley «MBW Smart»

Ένας αξιόπιστος συνεργάτης για την υπηρεσία minibar, με ανθεκτική δομή που επιτρέπει τη μεταφορά ποτών και μικροαντικειμένων για το mini bar των δωματιών.

*A reliable partner for minibar service with clearly structured divisions for efficient filling with bottles and small items.*

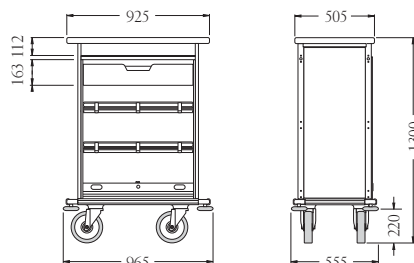

04.01250.95-V  
«MBW Smart-9»  
96,5x55,5 cm | 130 cm

### Κύρια χαρακτηριστικά

- Ατσάλινος ανθεκτικός σκελετός
- Δύο σταθερά και δύο ρυθμιζόμενα στο ύψος ράφια με κάγκελο για αποφυγή ολίσθησης.
- Περιμετρική προστασία σε κάθε γωνία του καροτσιού για αποφυγή τραυματισμών των τοίχων σας (All-round bumper profile).
- Ρολό που ανοίγει με κλειδαριά στην μπροσινή πλευρά του καροτσιού.
- Φινίρισμα σκελετού: επίστρωση μαγνητικής βαφής (powder coated), γκρι τιτανίου.
- Χρώματα πλαισίου: Anthracite, Natural oak, Mahogany.
- Τροχοί: 2 περιστρεφόμενες ρόδες και 2 σταθερές διαμέτρου 200 mm, πολυαμίδιο πέλμα.



## καρότσι μεταφοράς μπουκαδιών | mobile, space-saving bottle trolley

### Κύρια χαρακτηριστικά

- Ατσάλινος σκελετός τετράγωνου σωλήνα, πλευρικά τμήματα με πλέγμα σύρματος.
- Ρυθμιζόμενα ράφια.
- Φινίρισμα σκελετού: γαλβανιζέ επιχρωμιωμένο.
- Τροχοί: 4 περιστρεφόμενες ρόδες (δύο με φρένο & δύο χωρίς) διαμέτρου 125 mm πέλμα καουτσούκ με πλαστικούς δακτύλιους.

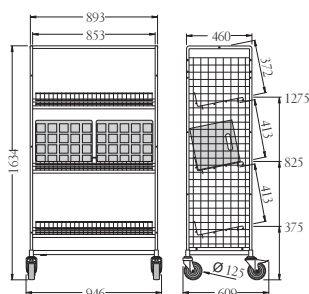

05.82378.50-0000  
«Bottle trolley 6»  
94,6x60,9 cm | 163,4 cm



## καρότσια ποδλαπιδών λειτουργιών «Hotel-max»



04.73112.96-0001  
«Hotel-max L»  
70,1x55,1 cm | 110,1 cm



Κομψά και ευέλικτα καρότσια πολλαπλών λειτουργιών! Τα καρότσια «Hotel-max S» και «Hotel-max L» μπορούν να γίνουν ο «αόρατος» συνεργάτης της καμαριέρας. Αποφεύγοντας την τυπική παρουσία καροτσιών προσφέρουν μια πολυτελή ατμόσφαιρα για τους επισκέπτες σας!

*«Hotel-max» Elegant and manoeuvrable multi-function transporters! The hotel-max S and the hotel-max L do their work as a constant, "invisible" companion to the chambermaid and thus prevent impairment of the overall impression given by hotels with an upmarket ambience.*

04.72999.96-0001  
«Hotel-max S»  
50,8x55,1 cm | 110,1 cm

### Κύρια χαρακτηριστικά

- Ατσάλινος ανθεκτικός σκελετός στρογγυλού σωλήνα με επιστροφή μαγνητικής βαφής (powder coated) και πυσσομένη βάση τοποθέτησης καλαθιού.
- Συρμάτινο καλάθι τοποθετημένο στη λαβή του καροτσιού με πλαστική εσωτερική βάση.
- Λαμβάνει πλεκτό πλαστικό καλάθι (δεν περιλαμβάνεται).
- 2 τροχοί κατασκευασμένοι από ανθεκτικό πλαστικό πέλμα.
- Πρόσθετα πλαστικά προφίλ που εξασφαλίζουν επιπλέον προστασία.

### Καλάθι «L»

#### Κύρια χαρακτηριστικά

- Πλεκτό πλαστικό με εσωτερικό διαχωριστικό, πλενόμενο, χρώμα μαύρο.
- Πρόσθετο μικρό πλεκτό καλάθκι.
- Ασφαλές για τρόφιμα, ανθεκτικό στη θερμότητα στους 70°C με προστασία αποχρωματισμού από ακτίνες UV.



05.47348.07-0001  
«καλάθι L»  
39x52 cm | 44 cm

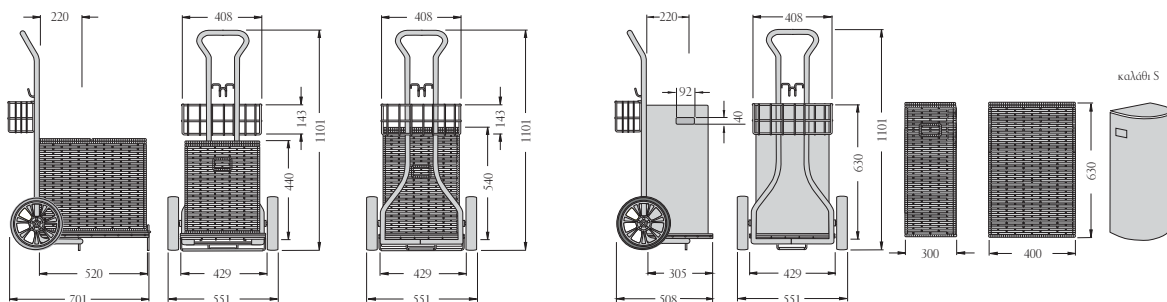

05.55258.07-9005  
«καλάθι S»  
30x40 cm | 63 cm

## τρόχει ορόφων «Mundus»

Η επανεφεύρεση στα καροτσάκια καμαριέρας! Το Mundus μπορεί να εξοπλιστεί ξεχωριστά καθώς τίποτα δεν είναι δεδομένο, είναι όλα προσαρμοσμένα. Δημιουργήστε το καροτσάκι καμαριέρας που ταιριάζει στις ανάγκες σας. Διαθέτει μια μεγάλη λίστα εξοπλισμού και αξεσουάρ που το καθιστά πάντα έτοιμο για χρήση και ιδανικό για κάθε εργασία.

*Housekeeping, reinvented! Create a custom chambermaid trolley to suit your needs. The Mundus can be equipped individually. Nothing is off the shelf, it is all tailor made. The trolley comes with a long list of practical equipment. Instead of standard configurations, we offer variety, meaning that the chambermaid trolley is always ready for use and is a perfect fit for any job in every establishment.*

### Κύρια χαρακτηριστικά

- Δυνατότητα προσαρμογής στα αισθητικά σας πρότυπα, επιλέγοντας όποιο συνδυασμό από τα 3 χρώματα σκελετών, 3 χρώματα υφασμάτων και 5 φινιρίσματα επιφανειών επιθυμείτε!
- Υβριδική κατασκευή σκελετού: χρήση ατσάλιου στον εσωτερικό σκελετό για μέγιστη αντοχή, και προφίλ αλουμινίου στα τελειώματα για μειωμένο βάρος και εύκολη μετακίνηση
- Περιμετρική προστασία σε κάθε γωνία του καροτσιού για αποφυγή τραυματισμών των τοίχων σας (All-round bumper profile).
- Εξαιρετική αντοχή σε βάρος: κάθε ράφι αντέχει με ασφάλεια τουλάχιστον 50 kg φορτίο.
- Συρτάρι με λειτουργία απαλού κλεισίματος
- Τροχοί με διπλά ρουλεμάν βαρέως τύπου, ειδικών προδιαγραφών για κάθε μέγεθος:  
Mundus 9 & 11: 4 περιστρεφόμενοι τροχοί 200 mm σύν έναν πέμπτο στο κέντρο (160 mm) με λάστιχο, για εύκολους επιτόπιους ελιγμούς  
Mundus 7:  
2 περιστρεφόμενοι τροχοί και 2 σταθεροί (200 mm)  
Mundus 5:  
4 περιστρεφόμενοι τροχοί (125 mm).

### Αξεσουάρ

Παρακαλούμε επικοινωνήστε μαζί μας.

04.08030.95-V  
«Mundus 9»  
170,7x58,6 cm | 129,1 cm

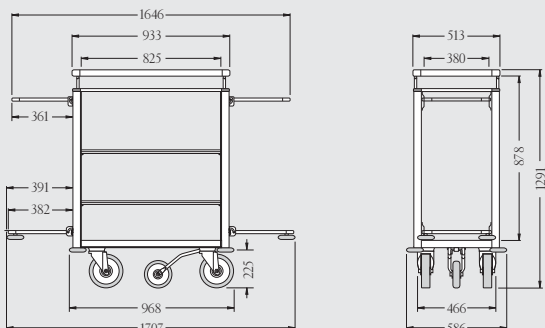

## τρόλεϊ ορόφων «ZP-Basic»

Ένα από τα πιο δοκιμασμένα σχέδια της Wanzl. Το τρόλεϊ «ZP-Basic» έχει ατσάλινη κατασκευή και είναι κατάλληλο για εσωτερικό ή εξωτερικό χώρο. Μπορεί να προσαρμοστεί στις ανάγκες σας, με την προσθήκη πρακτικών αξεσουάρ.

*The tried and tested design from Wanzl. The «ZP-Basic» trolley produced by steel and is suitable for indoor or outdoor use. It can be customised as required by adding practical accessories.*

04.01240.95-0000  
«ZP-Basic»  
162,5x56,5 | 112 cm



### Κύρια χαρακτηριστικά

- Ανθεκτικός σκελετός με ατσάλινη κατασκευή και εποξειδική βαφή.
- Δυο πλάγιες πτυσσόμενες υποδοχές για τοποθέτηση κρεμαστής σακούλας ρούχων και απορριμμάτων, με αντίστοιχες αναδιπλούμενες μεταλλικές βάσεις πλέγματος.
- Υψηλής ποιότητας σακούλα ρούχων από πολυεστέρα σε ανθρακί χρώμα
- Τρια σταθερά ράφια
- Τροχοί: 2 περιστρεφόμενες ρόδες και 2 σταθερές διαμέτρου 125 mm, πολυαμίδιο πέλμα.
- Φινίρισμα Platinum white

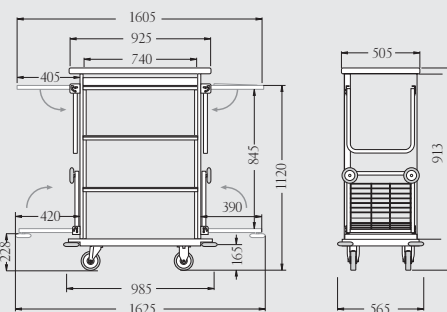

## πτυσσόμενο κρεβάτι «X-Bed»

Ένα πτυσσόμενο κρεβάτι με ύψος καθίσματος 55cm για εύκολη και άνετη χρήση! Το X-Bed διαθέτει πλέγμα οσάρας που επιτρέπει τον τέλει εξαερισμό του στρώματος.

*The «X-Bed» provides pleasant resting comfort with a seat height of approx. 55 cm it's grating support allows for perfect ventilation of the mattress.*

04.15256.73-7097  
«X-Bed»  
198,3x81,8 cm | 40 cm (ανοικτό)  
81,8x40,5 cm | 123,5 cm (κλειστό)

04.15482.07-0000  
στρώμα  
80x200 cm | 15 cm

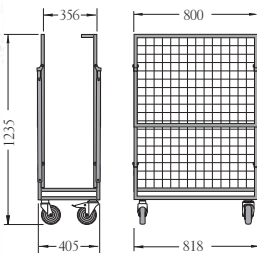

### Κύρια χαρακτηριστικά

- Ατσάλινος ανθεκτικός τετράγωνος σκελετός με υποστήριξη πλέγματος οσάρας.
  - Αυτόματος μηχανισμός αναδίπλωσης με ασφάλεια κλειδώματος.
  - Το μέγιστο βάρος που υποστηρίζει είναι 120 κιλά (ζυγίζει 23 κιλά).
  - Φινίρισμα σκελετού: επίστρωση μαγνητικής βαφής (powder coated), μεταλλικό μαύρο.
  - 4 περιστρεφόμενες ρόδες (2 με φρένο & 2 χωρίς) διαμ.: 125 mm
- ### Αξεσουάρ
- Στρώμα από αφρό πολυαιθέρα διαστάσεων 80x200x15 εκ. κατάλληλο για χρήση στο ξενοδοχείο (μπορεί να αποστειρωθεί).
  - Ανθεκτικό κάλυμμα χρώματος ανθρακί με καπιτονέ επιφάνεια, αφαιρούμενο και πλενόμενο.

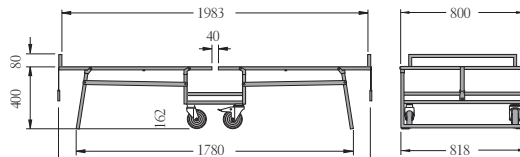



dorelan®  
dormire bene vivere meglio

*Κοιμηθείτε καλά, ζήστε καλύτερα: Dorelan για ξενοδοχεία!*

*Ως κορυφαίος κατασκευαστής στρωμάτων και κρεβατιών ποιοτικού ύπνου, η Ιταλική εταιρεία DORELAN με πάνω από 50 χρόνια εμπειρίας στην τουριστική βιομηχανία, προσφέρει προϊόντα προσαρμοσμένα στις απαιτήσεις κάθε ξενοδόχου. Επενδύοντας στην κατασκευή ποιοτικών κρεβατιών και στρωμάτων τελευταίας τεχνολογίας, για τον οίκο DORELAN σημαίνει και άμεση επένδυση στον πελάτη. Όσοι κοιμούνται καλά θα επιστρέψουν!*

*Sleep well, live better: Dorelan for hotels!*

*As a leading manufacturer of quality sleep mattresses and bed systems tailored to the individual requirements of the hotelier, Dorelan is an exclusively Italian company with over 50 years of experience in the tourism industry! Investing in the production of high quality beds and mattresses with state-of-the-art technology, means for DORELAN a direct investment in the customer. Those who sleep well will return!*

## «Vertical» κάθετο κρεβάτι

Το «Vertical» είναι ένα καινοτόμο σύστημα extra bed και αποτελεί την ιδανική λύση για όσους θέλουν να βελτιστοποιήσουν το χώρο του ξενοδοχείου. Το παχύ σιδερένιο πλαίσιο εγγυάται μέγιστη σταθερότητα για το σκελετό και τα πόδια, ενώ η φαρδιά ξύλινη βάση και οι τροχοί εξασφαλίζουν σταθερότητα και εύκολο χειρισμό του κρεβατιού όταν είναι κάθετα τοποθετημένο.

*«Vertical» is an innovative additional bed system providing the ideal solution for anyone looking to optimise hotel room space. The thick iron frame guarantees utmost solidity for the frame and feet, while the wide wooden base and wheels ensure stability and easy handling of the bed when vertically positioned.*

### Κύρια χαρακτηριστικά

- Σκελετός από σίδηρο 50x33 mm.
- Μεγέθος 85x205 cm | 35 cm.
- Ξύλινο κεφαλάρι επενδεδυμένο με δερματίνη.
- Κάθετο πλαίσιο με εύκαμπτες ράγες από κόντρα πλακέ οξιάς.
- Σύστημα ασφαλείας με δύο ελαστικούς ιμάντες με πρακτικό γάντζο για τη συγκράτηση του στρώματος.
- Βάση με τέσσερις τροχούς και φρένα.
- Πτυσσόμενα πόδια για εύκολη μετακίνηση.
- Σχεδιασμένο για στρώμα 80x190 cm | 23 cm (δεν περιλαμβάνεται).

### Αξεσουάρ

- Βαμβακερό κάλυμμα για προστασία του στρώματος σε κατακόρυφη θέση.
- Υφασμάτινο κάλυμμα για κεφαλάρι και πλαίσιο.



Συνδυάστε το με ένα από τα κορυφαία σε πωλήσεις στρώματα του οίκου Dorelan π.χ. «Premier», «Class», «Incanto», «Reactive», «Millenaire»



Από το 1928 η Caddie σχεδιάζει και κατασκευάζει ποιοτικά και πρωτοποριακά προϊόντα. Είναι διεθνώς αναγνωρισμένη στον τομέα της «ο προμηθευτής σημείο αναφοράς» για την ξενοδοχειακή βιομηχανία.

Από το 2015 με ανανεωμένη οργάνωση επικεντρώνεται πλήρως στα προϊόντα φιλοξενίας με στόχο να γίνει ακόμη πιο αποδοτική για τον πελάτη της.

As an industry pioneer since 1928, Caddie designs and manufactures innovative handling equipment for hotels. The assets that have driven our expansion and success are the exclusively European manufacturing and the customer-centric product development, enabled by our in-house design office. This has allowed us to set up a reliable, durable and functional range for housekeeping, front office, conference as well as laundry and room service.

## τρόλεϊ αποσκευών «Orsa Dakar» luggage trolley

Αναδιπλούμενο τρόλεϊ με μικρό όγκο για εξωτερική χρήση. Αντέχει 150 kg βάρους και δέχεται 6-7 βαλίτσες.

Φουσκωτές ρόδες, 26 cm  
Επιλογή από 4 χρώματα  
μοκέτας: γκρι, μπλε, κόκκινη, μαύρη.

*Foldable luggage trolley especially designed for narrow storage space and outdoor. Load capacity 150kg. Suitcase capacity 6-7 suitcases. Pneumatic wheels, 30 cm. Carpet colors: grey, red, blue, black.*



* 010501IN	«Orsa Dakar» stainless steel ανοιχτό/open: 102x108 cm   110 cm κλειστό/closed: 41,1x108cm   110 cm
---------------	---

## τρόλεϊ αποσκευών «Orsa» luggage trolley

Αναδιπλούμενα τρόλεϊ  
Αντέχουν 150 kg βάρους  
και δέχονται 6-7 βαλίτσες.  
Αθόρυβες μεγάλες ρόδες,  
30 cm. Επιλογή από 4  
χρώματα μοκέτας: γκρι,  
μπλε, κόκκινη, μαύρη.

*Foldable luggage trolleys.  
Load capacity 150kg,  
Suitcase capacity 6-7 suitcases  
Silent big castors, 30 cm  
Carpet colors: grey, red, blue,  
black.*



* 010500IN	«Orsa IN» brushed stainless steel ανοιχτό/open: 105,2x57,3 cm   116 cm κλειστό/closed: 43,8x57,3 cm   116 cm
---------------	---

τρόλεϊ αποσκευών | *luggage trolley «Transbag One»*



Αντέχουν 300 kg βάρους και δέχονται 9-12 βαλίτσες. Επιλογή από 4 χρώματα μοκέτας: γκρι, μπλε, κόκκινη, μαύρη. Δέχονται προαιρετικά φουσκωτές ρόδες.

*Load capacity 300kg.  
Suitcase capacity 9-12 suitcases  
Carpet colors: grey, red, blue, black.  
Optional inflated wheels.*

* 99720909	«Transbag One BR» steel brass finish 112x65 cm   192 cm
* 997290IN	«Transbag One IN» matt finish 112x65 cm   192 cm
* 997290CR	«Transbag One CR» chromed matt finish 112x65 cm   192 cm

τρόλεϊ αποσκευών | *luggage trolley «Smart»*

Αντέχουν 300 kg βάρους και δέχονται 8-10 βαλίτσες. Επιλογή από 4 χρώματα μοκέτας: γκρι, μπλε, κόκκινη, μαύρη

*Load capacity 300kg,  
Suitcase capacity 8-10 suitcases.  
Carpet colors: grey, red, blue, black.*



* CAD00055	«Smart BR M» steel brass finish 94x59,5 cm   183 cm
* CAD00056	«Smart BR L» steel brass finish 111x59,5 cm   183 cm
* CAD00050	«Smart CR M» chromed matt finish 94x59,5 cm   183 cm
* CAD00048	«Smart CR L» chromed matt finish 111x59,5 cm   183 cm

τρόλεϊ αποσκευών | *luggage trolley «Transbag delta»*

- Κατασκευή από ανοξείδωτο ατσάλι
- Μαύρη λαστικένια περιμετρική λωρίδα στη βάση για αποφυγή χτυπημάτων σε τοίχους
- Ράγα κρεμάστρας για τοποθέτηση κρεμάστρας
- Ξύλινη βάση με σκούρα μπλε μοκέτα.
- max 150 kg
- Για 8-10 βαλίτσες

- *Steel tube with chrome finish*
- *Non-marking and full wrap-around rubber bumper in black*
- *Hanging rail for coat hangers*
- *Wooden base with dark blue carpet*
- *max. 150 Kg*
- *Suitcase capacity 8-10 suitcases*

* CAD00166	«Transbag delta» stainless steel 95x55 cm   183 cm
---------------	--





# The caddie®

Το αθόρυβο τρόδεϊ!  
Το προσαρμοζόμενο στις ανάγκες σας τρόδεϊ είναι διακριτικό, αθόρυβο, ελαφρύ, κομψό και αποδοτικό. Πάγιες σει από δύο ξεχωριστά στοιχεία, που μαζί προσφέρουν τέλεια και αποτελεσματική υπηρεσία.

The Caddie provides your guests the premium and high-end experience they expect from your facility, ensuring discreet look and cleanliness during your daily housekeeping operations. Invisible In-room housekeeping has now reached its peak.



## «The caddie»

* 050603XX	«The caddie Buddie» 45x45 cm   89 cm
* 050601XX	«The caddie Handie» 45x45 cm   62 cm
* 050602XX	«The caddie Trendie» 45x38 cm   27 cm



Trendie



Ιμάντας ασφάλειας  
Heavy duty fastening strap



- Επιλογή από μαλακό καπάκι με επιπλέον εσωτερικές τσέπες ή σκληρό καπάκι για γρήγορο service. | You can choose to have either a soft-top with additional inner pockets or a hard-top version for an even quicker service
- 2 ή 4 ροδές (2 σταθερές και 2 περιστρεφόμενες) | 2 or 4 wheels (2 fixed and 2 wivel castors).
- Σταθερές και αθόρυβες ροδές με διπλό ρουλεμάν. | Sturdy and silent Nylon wheels with double ball bearing.
- Μεγάλες πίσω ροδές για μακροχρόνια χρήση. | Big 110mm rear wheels ensure long durability.
- Στάνταρντ χρώματα μαύρο, καφέ ή μπορντό (διατίθενται και άλλα χρώματα). Standard colors are black, brown and burgundy but many other colors available.



Handie



Buddie



Θήκη ειδών καθαρισμού  
Cleaning items will always have their place



Πλαστική θήκη με χωρίσματα  
Rigid plastic Caddie with inner adjustable velcro dividers for amenities



Η παράδοση συνεχίζεται.

Με νέα ανθεκτικότερα αθόρυβα τοιχώματα HPL, συνθετικές ρόδες, το «Tabiti» είναι πιο ελαφρύ, πιο σταθερό και αθόρυβο. Η μεγάλη ποικιλία εξοπλισμού βοηθά να διαδέγετε το καιάδηδη εφοδιασμένο τρόποει για να εκτελείτε την εργασία σας αποδοτικότερα.

Capitalizing on decades of experience, the Tabiti has been improved! With new HPL paneling and composite casters, the Tabiti is now lighter, sturdier and quieter than ever. A broad range of options will enable you to configure the perfect equipment for your operations.

### standard εξοπλισμός

- Μεταλλικός σκελετός (steel) βαμμένος γκρι (PAL 9006 powder coating) και αθόρυβα τοιχώματα HPL  
Steel tube frame with a grey (RAL9006) powder coating and HPL panels.
- Ρόδες από συνθετικό πλαστικό για μοκέτες υψηλής κυκλοφορίας ή μωσαϊκό.  
Silent casters with composite fork for high traffic carpet.
- 4 ράφια, τα 2 εύκολα ρυθμιζόμενα καθ' ύψος χωρίς χρήση εργαλείων.  
4 shelves (3 inside) of which 2 (toolfree) height adjustable shelves.
- Δεξιά πλευρά επάνω: μηχανισμός στήριξης που ανασκώνεται και λινή σακούλα 127 lt.  
Right side: Upper liftable holder for a linen bag. (One bag of 127L inc.)
- Αριστερή πλευρά επάνω: μηχανισμός στήριξης σάκου απορριμμάτων που ανασκώνεται, με καπάκι.  
Left side: Upper liftable holder for a waste bag (a set of bags inc.) with a lid.
- Δεξιά και αριστερή πλευρά κάτω: μηχανισμός προστασίας με ροδάκια που διπλώνει.  
Right and left: lower liftable holders with donut bumper at each corner. + option list hereunder.

Χρωματισμοί τοιχωμάτων - Panel finish



slate

wenge

cacao

«Tabiti»



\* «Tabiti S»  
050202HPL 7-10 δωματίων  
room linen capacity: 7-10  
133,5x57 cm | 133 cm

\* «Tabiti M»  
050203HPL 10-13 δωματίων  
room linen capacity: 10-13  
155,5x57 cm | 133 cm

\* «Tabiti L»  
050204HPL 13-16 δωματίων  
room linen capacity: 13-16  
175,5x57 cm | 133 cm

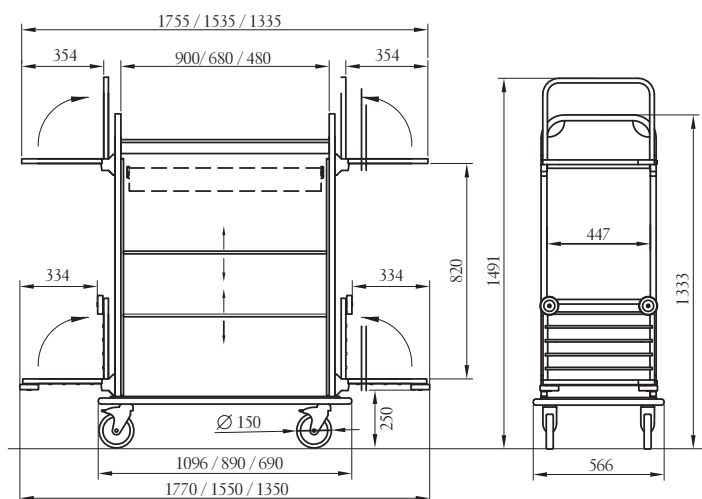

options:  
C - CC -  
BP - D -  
E/R -  
RNY

σελίδα  
535

Τρόλεϊ «Fidji» με τα ίδια χαρακτηριστικά με τα «Tabiti» αλλά πιο στενά κατά περίπου 8 cm

Fidji trolley with the same features with «Tabiti» but more narrowly against about 8 cm

### standard εξοπλισμός

- Μεταλλικός σκελετός (steel) βαμμένος γκρι (PAL 9006 powder coating) και αθόρυβα τοιχώματα HPL  
Steel tube frame with a grey (RAL9006) powder coating and HPL panels.
- Ρόδες από συνθετικό πλαστικό για μοκέτες υψηλής κυκλοφορίας ή μωσαϊκό.  
Silent casters with composite fork for high traffic carpet.
- 4 ράφια, τα 2 εύκολα ρυθμιζόμενα καθ' ύψος χωρίς χρήση εργαλείων.  
4 shelves (3 inside) of which 2 (toolfree) height adjustable shelves.
- Δεξιά πλευρά επάνω: μηχανισμός στήριξης που ανασπώνεται και λινή σακούλα 127 lt.  
Right side: Upper liftable holder for a linen bag. (One bag of 127L inc.)
- Αριστερή πλευρά επάνω: μηχανισμός στήριξης σάκου απορριμμάτων που ανασπώνεται με καπάκι.  
Left side: Upper liftable holder for a waste bag (a set of bags inc.) with a lid.
- Δεξιά και αριστερή πλευρά κάτω: μηχανισμός προστασίας με ροδάκια που διπλώνει.  
Right and left: lower liftable holders with donut bumper at each corner. + option list hereunder.



Χρωματισμοί τοιχωμάτων - Panel finish



### «Fidji»

\* τρόλεϊ «Fidji S»  
050402HPL 5-8 δωμάτια  
room linen capacity: 5-8  
133x48,5 cm | 133,3 cm

\* τρόλεϊ «Fidji M»  
050403HPL 9-12 δωμάτια  
room linen capacity: 9-12  
155x48,5 cm | 133,3 cm

\* τρόλεϊ «Fidji L»  
050404HPL 12-15 δωμάτια  
room linen capacity: 12-15  
170x48,5 cm | 133,3 cm

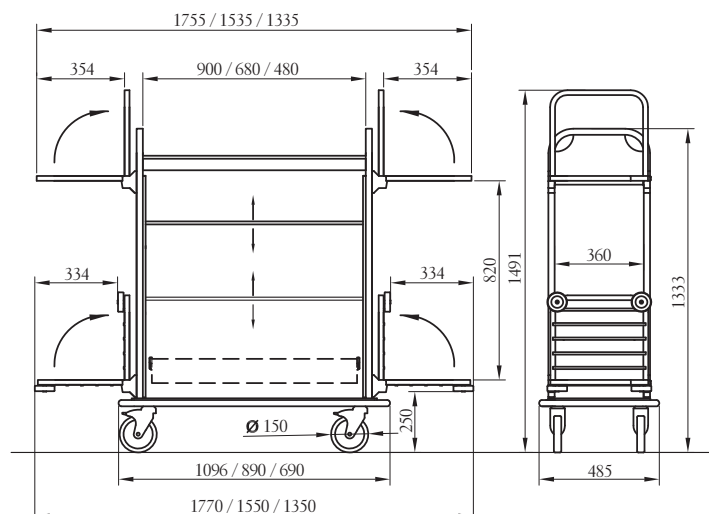

options:  
C- CC - D  
E/R - BP  
RNY

Ελαφρύ, αθόρυβο και αδιάβροχο, για όλες τις επιφάνειες.

Οι ποδύ ελαστικές ρόδες του μπορούν να κυλήσουν επάνω σε ανώμαλες επιφάνειες και οι πόρτες του κλειδώνουν προσιατεύοντας το εσωτερικό του.

*The Dakar is especially designed for outdoor use. Its sturdy build, along with the elastic, soft castor features, makes it very useful on uneven, outdoor surfaces. Equipped with lockable doors which protect the content from pollution.*

### standard εξοπλισμός

- Μεταλλικά τοιχώματα βιδωμένα σε μεταλλική βάση, βαμμένα γκρι (PAL 9006 powder coating).  
*Full metal sheet structure with a corrosion-preventative grey powder coating in RAL 9006.*
- Υπέρ-ελαστικές ρόδες (για ελαφρώς ανώμαλο δάπεδο)  
*4 swivel castors 200 mm 'RG' of which 2 with a brake.*
- 2 ράφια εύκολα ρυθμιζόμενα ' ύψος  
*2 height adjustable shelves*
- Σετ μεταλλικές πόρτες που κλειδώνουν.  
*Lockable metal doors*



### «Dakar ALU»

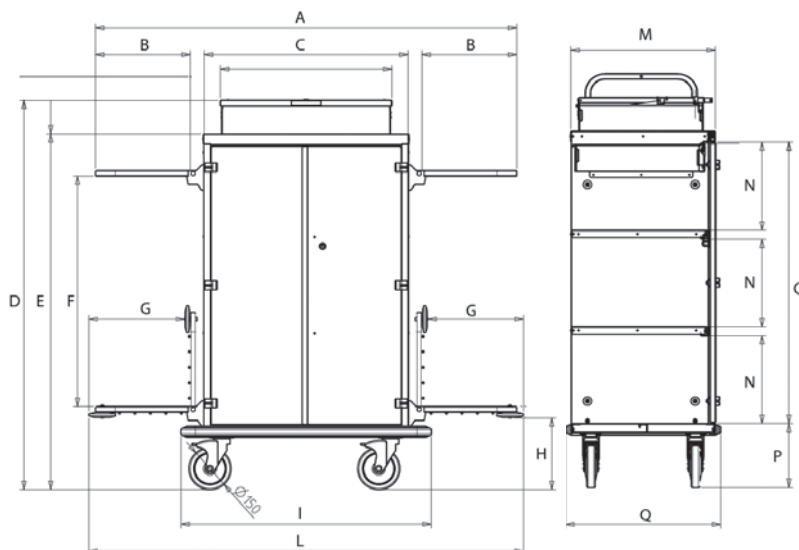

\* CAD00117 «Dakar ALU»  
9-12 δωμάτια  
room linen capacity: 9-12  
154,4x55 cm | 138,6 cm

options:  
C- CC -  
RNY - D  
BP

σελίδα  
535

Όμορφο σχέδιο κλασσικό, διακριτικό στυλ.  
Πολλές επιλογές ανάλογα με τις ανάγκες σας.

*GEORGE with its beautifully crafted and classic touch equipment, and its discreet charm will perfectly complement your interior decoration. This model also offers many available options in order to customize the user's specific needs and requirements.*



### standard εξοπλισμός

- Εξολοκλήρου κατασκευασμένο από ξύλο Laminated σε 9 χρωματισμούς.  
*Fully laminated wood structure, 9 decorative schemes available*
- Δύο ράφια ευκολά ρυθμιζόμενα καθ' ύψος.  
*2 height adjustable shelves*
- Ελαστικές ρόδες που δεν αφήνουν ίχνος.  
*Non marking and full wrap-around rubber bumper*
- Πάνω μέρος με ρυθμιζόμενα χωρίσματα.  
*Top level with integrated-small items-box incl. adjustable separators for convenient organization*
- 4 περιστρεφόμενες ρόδες 15 cm, οι δύο με φρένο.  
*4 swivel castors 150 mm 'CMP' of which 2 with a brake.*

### Χρωματισμοί τοιχωμάτων - Panel finish



### «George»

- \* «George S»  
050102WD 5-8 δωμάτια  
room linen capacity: 5-8  
133x53,5 cm | 127 cm
- \* «George M»  
050103WD 10-13 δωμάτια  
room linen capacity: 10-13  
153x53,5 cm | 127 cm
- \* «George L»  
050104WD 12-15 δωμάτια  
room linen capacity: 12-15  
170,6x53,5 cm | 127 cm

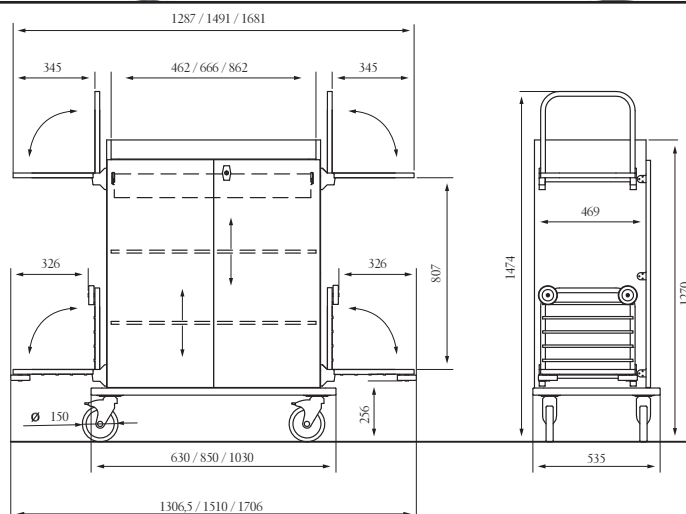

options:  
C - D - E  
RNY

σελίδα  
535

Το μικρότερο τρολεϊ διωματιών της αγοράς.

Λιγότερο από 55 cm φάρδος και πλάτος.

Μπορεί να μπει σε μικρά ασανσέρ.

Οι μεγάλες πίσω ρόδες και λαβές του δίνουν τη δυναμότητα, γέροντας προς τα πίσω, να περάσει εμπόδια και να κατέβει σκαλοπάτια. (προαιρετικός μηχανισμός clip σύνδεσή του με το «Tabiti L».

- Μεταλλικός σκελετός (steel) βαμμένος γκρι (RAL 9006 powder coating και αθόρυβα τοιχώματα HPL.

The HALLEY 2 is one of the smallest trollies on the market.

It is less than 55 cm in width and depth, which makes it small, flexible and agile enough for easy access to small spaces.

(Optional clip mechanism connects to «Tabiti L»)

- Light and sturdy steel tubing structure with a grey powder coating in RAL 9006 and side and rear paneling made of HPL

Χρωματισμοί τοιχωμάτων - Panel finish



slate

wenge

cacao

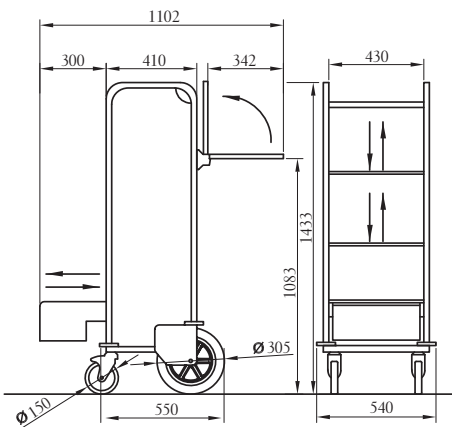

options:

C- CC - E/R

\* 050401HPL

«Halley»  
3-5 δωματιών  
room linen capacity: 3-5  
55x54 cm | 143,3 cm

<p><b>C</b></p>  <p>Θήκη αντικειμένων Small items box</p>	<p><b>CC</b></p>  <p>Θήκη αντικειμένων με καπάκι Small items box with lid</p>	<p><b>D</b></p>  <p>Μεταλλικό εσωτερικό συρτάρι με ρυθμιζόμενα χωρίσματα και στοπ Metal drawer with adjustable separators</p>	<p>options για τρολεϊ trolleys options</p>
<p><b>E/R</b></p>  <p>Πόρτα roller που κλειδώνει Shutter lockable</p>	<p><b>RNY</b></p>  <p>4 ρόδες για παχιά μοκέτα, οι 2 με φρένο 4 castors ideal for deep carpet</p>	<p><b>E</b></p>  <p>πόρτες που κλειδώνουν lockable doors</p>	

## «Charlotte» τρόλεϊ bar-service - bar-service trolley

caddie

Όμορφο σχέδιο κλασσικό, διακριτικό σιντ. Πολλάς επιλογές ανάλογα με τις ανάγκες σας.

Apart from its well-thought-out internal features, inspires with its pure elegance, allows for the perfect fit of interior designs.

- Εξολοκλήρου κατασκευασμένο από ξύλο laminated σε 9 χρωματισμούς.  
Fully laminated wood structure, 9 decorative schemes available

- 3 μεταλλικά συρτάρια με ρυθμιζόμενα διαχωριστικά HPL. Μέγιστο ύψος συρταριών: πάνω 14cm - μεσαίο 24cm - κάτω 30cm.  
3 metal drawers with separators; storage height: top 14 cm, middle 24 cm, bottom 28cm, base shelf 30 cm

- Λαστιχένιος προφυλακτήρας που δεν αφήνει ίχνος | Non-marking and full wrap-around rubber bumper
- Με λαβή ώθησης. | With push handle
- Άνω μέρος με ρυθμιζόμενα διαχωριστικά. | Top level with integrated small items box incl. separators
- 4 περιστρεφόμενες ρόδες 15 cm οι δυο με φρένο και προαιρετικός πέμπτος τροχός για καλύτερη ευελιξία. 4 swivel castors 150 mm 'CMP', 2 with brakes and an additional 5th castor 'RS5' for a better maneuverability when fully loaded



### Χρωματισμοί τοιχωμάτων - Panel finish



options:  
RNY

σελίδα  
535

### «Charlotte»

* 080103WD	«Charlotte M» max 150 kgr 85x53,5x127 cm
* 080104WD	«Charlotte L» max 150 kgr 103x53,5x127 cm

## «Bora Bora» τρόλεϊ bar-service - bar-service trolley



- Ελαφρύς ισχυρός σκελετός (steel) βαμμένος γρι (pal 9006 powder coating).  
Light and sturdy steel tube structure with a grey powder coating in RAL 9006
- Ανθεκτικά αθόρυβα τοιχώματα HPL (πλαϊνά και πλάτη).  
Side and rear paneling made of HPL (shock proof, water tight and resistant surface), 3 decors available
- Ρόδες ελαστικές που δεν αφήνουν ίχνος.  
Non marking and full wrap-around rubber bumper

- Πόρτα roller που κλειδώνει.  
Lockable shutter
- 3 μεταλλικά συρτάρια με HPL χωρίσματα (2 σε βάθος και 3 σε μήκος).  
3 metal drawers with separators made of HPL (2 pcs. for M, 3 pcs. for L)
- 4 περιστρεφόμενες ρόδες 15 cm (οι δύο με φρένο) και επιπρόσθετη 5η ρόδα για μεγαλύτερη ικανότητα. 4 swivel castors 150 mm 'CMP', 2 with brakes and an additional 5th castor 'RS5' for a better maneuverability when fully loaded

### Χρωματισμοί τοιχωμάτων - Panel finish



options:  
C- CC -  
E/R - RNY

σελίδα  
535

\* «Bora -Bora M»  
max 150 kgr  
89x56,6x133 cm

\* «Bora -Bora L»  
max 150 kgr  
109,6x56,6x133 cm



## «Caddie Sac Easy &amp; Hydro»

Λεπτή γραμμή, εύκολη αθόρυβη κίνηση (συνθετικές ρόδες 12,5 cm οι δύο με φρένο), μεγάλη χωρητικότητα 192 lt

*Slim line, 4 castors 12,5 cm, steel tube frame with grey powder coating RAL 9006, detachable laundry bag (192 liters)*



\* «Caddie Sac Easy»  
060100 LN με ενισχυμένο σάκο  
*reinforced laundry bag*  
(92x45 cm | 54 cm)  
103x56,2 cm | 91,5 cm



\* «Caddie Sac Hydro»  
060100 BDX με ενισχυμένο  
αδιάβροχο σάκο  
*reinforced laundry durable*  
*water repellent bag*  
(92x45 cm | 54 cm)  
103x56,2 cm | 91,5 cm

## τρολέϊ απδύτων - laundry trolleys «Caddie Trisac»

Λεπτή γραμμή, εύκολη αθόρυβη κίνηση (συνθετικές ρόδες 12,5 cm). | *Slim line, 4 castors 12,5 cm, steel tube frame with grey powder coating RAL 9006.*



\* «Caddie Trisac 1»  
060201 LN με σάκο 80 lt  
*with laundry bag 80 lt*  
45x45 cm | 69 cm  
56,2x25,2 cm | 106,5 cm



\* «Caddie Trisac 3»  
060203 LN με 3 σάκους 80 lt  
*with 3 laundry bags 80 lt*  
(107x45 cm | 69 cm)  
118,2x56,2 cm | 106,5 cm

## «Caddie X»



\* «Caddie X»  
060101 LN πτυσσόμενο τρολέϊ  
με ενισχυμένο  
σάκο 150 lt με κορδόνι  
*Foldable steel tube frame trol-*  
*ley with polyester bag*  
*of 150 liters*  
53,5x49 cm | 105 cm

## «Ibiza Trisac 2»



\* «Ibiza Trisac 2»  
0605021B τρολέϊ με σκελετό από τε-  
τράγωνους σωλήνες γκρι  
*powder coating in RAL*  
*9006 και 2 σάκους 87 lt*  
*Square steel tube frame with*  
*grey powder coating in RAL*  
*9006, 2 polyester bags of 87*  
*liters included*  
56,2x82,2 cm | 104 cm

## τρολέϊ μαρισμού «Roll Sicurezza 1»



\* «Roll Sicurezza 1»  
ROLLSI1 70x80 cm | 180 cm

- σταθερός σκελετός από ατσάλι και συρμάτινο γαλβανιζέ πλέγμα
- μονοκόμια μπροστινή πόρτα με άνοιγμα 270°
- 2 περιστρεφόμενοι και 2 σταθεροί τροχοί
- Προερατικός εξοπλισμός: ράφι και κάλυμα για εξωτερική χρήση. Αντοχή max 100 kg
- *Steel tube frame with wire mesh, electrolytically galvanized*
- *1 full-height door opening at 270°*
- *2 swivel and 2 fixed - 125 mm*
- *Optional equipment: shelf and cover for outdoor use*
- *max weight 100 kg*

## τρολέϊ μαρισμού «Roll Sicurezza 2»



\* «Roll Sicurezza 1»  
ROLLSI2 70x80 cm | 180 cm

- σταθερός σκελετός από ατσάλι και συρμάτινο γαλβανιζέ πλέγμα
- 2 μπροστινές πόρτες με άνοιγμα 270°
- 2 περιστρεφόμενοι και 2 σταθεροί τροχοί
- Προερατικός εξοπλισμός: ράφι και κάλυμα για εξωτερική χρήση. Αντοχή max 100 kg
- *Steel tube frame with wire mesh, electrolytically galvanized*
- *doors opening at 270°*
- *2 swivel and 2 fixed - 125 mm*
- *Optional equipment: shelf and cover for outdoor use*
- *max weight 100 kg*



## «Flip Top» room service trolley

- Καπάκι 90 cm από συμπαγούς πυκνότητας φυσικών ινών ξύλου σε χρώμα γραφίτη, αντιολισθητικό και υψηλής αντίστασης στα γδαροίματα επιφάνεια. | 90 cm table top made of solid compact density fiber wood in graphite color finish, scratchproof and anti-slip surface
- Σκελετός από χαλύβδινο σωλήνα με φινίρισμα χρωμίου, δέχεται ταυτόχρονα 2 hot box. | Steel tube frame with chrome finish, fits up to 2 hot boxes at the same time
- Πλαϊνές πλευρές που διπλώνουν. | Fold down side pages
- Καπάκι που γυρίζει στο πλάι κερδίζοντας χώρο όταν δεν χρησιμοποιεί τα τροχά. Whole table top flips vertically and is lockable, saving space for nesting while not in use



- 4 περιστρεφόμενους τροχούς 125 mm «TPP», 2 με φρένα | 4 swivel castors 125 mm «TPP», 2 with brakes

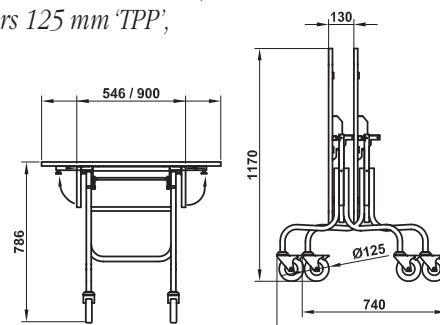

\* «Flip Top»  
090103 54,6/90x74x78,6 cm

## «Hot Box»

Ηλεκτρικό ισοθερμικό inox κουτί, 500W (30-90°C), πόρτα με μαγνήτες και 2 πλαστικά χερουλά και 2 οσάρες. Δέχεται πιάτο με διάμετρο έως 32 cm.

Electric insulated inox Hot Box 500W (30-90°C), doors with a magnetic latch and 2 plastic handles and 2 grids. Suitable for plates up to 32cm.



\* «Hot box»  
0902001N 38x40,5 cm | 51,2 cm

## «Box Taxi» τροχά για μεταφορά των ισοθερμικών κιβωτιών Trolley for HOT



- Τροχά για μεταφορά των ισοθερμικών κιβωτιών Trolley for HOT BOXES
- 2 ράφια για μεταφορά 6 θερμοκιβωτιών 2 levels for a total load capacity of 6 HOT BOXES
- Διαθέτει καλωδίωση σχεδιασμένη για μεμονωμένη ή ταυτόχρονη θέρμανση των θερμοκιβωτιών με ένα μόνο βύσμα ρεύματος | Cabling designed for either individual or simultaneous heating of HOT BOXES with just one power plug
- 4 περιστρεφόμενοι τροχά φ 125 mm «TPP», 2 από τους οποίους διαθέτουν φρένο. 4 swivel x φ 125 mm «TPP» with donut bumpers, 2 of which with brake
- Άντοχή max 150 kg | max weight 150 kg

\* «Box Taxi»  
0902011N 146,7x56,2 cm | 136,3 cm

## παιδικό κρεβάτι | baby bed «Sleep'n play»

Άνετο, ασφαδές, εύκολο στην αποθήκευση. Προαιρετικό στρώμα μακροήμερους διαμονής.

Large, comfortable and versatile (bed and secured play area), this bed is also very convenient as it can be completely folded for storage. The optional comfort mattress is ideal for longer stays.



- Μεταλλικός πτυσσόμενος σκελετός | Re-inforced and soft covered metal frame, easily foldable
- Έγχρωμα προστατευτικά γωνίας | Colored corner protection
- Διατίθεται με στρώμα 2cm (πάχος) | Standard mattress 2 cm (thickness)
- 2 ημιδιαφανείς πλευρές με πλέγμα | 2 translucent sides with mesh
- Άνοιγμα στο πλάι με φερμουάρ | Side opening with zipper
- Φορητό με λαβή μεταφοράς | Portable with carry handle
- 2 ρόδες 10 cm | 2 castors 10 cm

\* «baby bed «Sleep'n play»  
090300PL max 15 kgr  
125x65 cm | 76 cm

## σκαμνιά βαλιτσών | luggage racks

Αναδιπλούμενα σκαμνιά βαλιτσών χρωμίου με μαύρους ιμάντες. Διάμετρος σωλήνα 2,5 cm.

Folding suitcase rack in chromed metal with straps in black PVC. Tubular diam. 2,5 cm

Αναδιπλούμενα σκαμνιά βαλιτσών χρυσαφί με μαύρους ιμάντες. Διάμετρος σωλήνα 2,5 cm.

Folding suitcase rack in gold finish with straps in black PVC. Tubular diam. 2,5 cm



\* «Luggage rack CR»  
AD00031 max 60 kgr  
68x43 cm | 52 cm

\* «Luggage rack CR S»  
AD00032 με πλάτη | with backrest  
max 60 kgr  
68x43 cm | 71,5 cm



\* «Luggage rack BR»  
AD00033 max 60 kgr  
68x43 cm | 52 cm

\* «Luggage rack BR S»  
AD00034 με πλάτη | with backrest  
max 60 kgr  
68x43 cm | 71,5 cm

## κουδούνι υποδοχής



30.40307 κουδούνι υποδοχής  
8,5 cm | 6 cm  
pack: 1



97.13091 σκαμνιά βαλιτσών ξύλινο  
wooden suitcase rack  
55x70 cm | 60 cm



**caddie**

\*  
«Sipga» brass  
030100 BR  
5/30 cm | 91 cm

\*  
«Sipga» inox  
030100 IN  
5/30 cm | 91 cm

**HENDI**

30.41622  
gold  
51 cm | 93,5 cm  
pack: 1

30.41620  
inox  
51 cm | 93,5 cm  
pack : 1

**HENDI**

30.41621  
inox,  
με ταινία  
with intergrated  
belt  
36 cm | 82,5 cm  
pack: 1

πινακίδες ανακοινώσεων | information panels



**caddie**

Οι πινακίδες  
μπορούν να τοποθετηθούν  
οριζόντια ή κάθετα στα κολωνάκια.  
*Information panels can be used  
in portrait or landscape orientation*

\*  
030202BRKIT polished brass, A3  
πίνακας: εξωτερικά steel /  
εσωτερικά χρυσό  
frame: outside steel,  
inner gold-colored

\*  
030201BRKIT polished brass, A4  
πίνακας: εξωτερικά steel /  
εσωτερικά χρυσό  
frame: outside steel,  
inner gold-colored

κορδόνια «σχοινί» | cords 1,5m

**HENDI**



30.41623  
810453 κόκκινο - inox  
red - inox  
pack : 1

30.41625  
810477 κόκκινο - χρυσό  
red - gold  
pack : 1

30.41624  
810460 μπλε - inox  
blue- inox  
pack : 1

**caddie**



Δέχονται μέχρι και  
4 κορδόνια.



\*  
030202CRKIT inox, A3  
πίνακας: εξωτερικά steel /  
εσωτερικά μαύρος  
frame: outside steel,  
inner black

\*  
030201CRKIT inox, A4  
πίνακας: εξωτερικά inox /  
εσωτερικά μαύρος  
frame: outside steel,  
inner black

κορδόνια «σχοινί» | cords 1,5m

**caddie**



\*  
030301 CR κόκκινο/red | inox  
pack: 1

\*  
030301 BR κόκκινο/red / brass  
pack: 1

\*  
030302 CR μπλε/blue / inox  
pack: 1

\*  
030302 BR μπλε/blue / brass  
pack: 1

\*  
030303 CR μπεζ/beige / inox  
pack: 1

\*  
030303 BR μπεζ/beige / brass  
pack: 1

\*  
030304 CR μαύρο/black / inox  
pack: 1

\*  
0303024 BR μαύρο/black / brass  
pack: 1



30.41406 σταχτοδοχείο επιτοίχιο  
inox  
wall mounted ashtray  
7,5 cm | 46 cm  
pack: 1

30.41407 σταχτοδοχείο δαπέδου  
inox  
wall mounted ashtray  
17 cm | 92 cm  
pack: 1



\*34.60165 σταχτοδοχείο επιτοίχιο  
inox, με αφαιρούμενο  
κάδο και κλειδαριά  
26x28x16 cm  
pack: 1



\*27.00574 σταχτοδοχείο δαπέδου  
standing ashtray  
40 cm | 60 cm  
pack: 1

πινακίδες wet floor | wet floor signs



πινακίδα «Attention»  
σε 5 γλώσσες  
wet floor sign, warning in 5 languages

30.40354 30 cm | 61,5 cm  
pack: 1

κάδοι | bins



κάδος απορριμμάτων πεντάλ,γκρι  
με ρόδες και καπάκι, 50 lt  
outdoor pedanal bin  
with wheels and green lid, 50 lt  
46,7x43,5 cm | 62 cm

46.31215 μπλε καπάκι blue lid  
pack: 1

46.51215 κίτρινο καπάκι yellow lid  
pack: 1

46.71215 πράσινο καπάκι green lid  
pack: 1

βάση συγκράτησης σακούλας | trash bag holder



30.41076 βάση συγκράτησης  
σακούλας σκουπιδιών  
trash bag holder  
42x58 cm | 96 cm  
pack: 1



21.76805 κάδος κήπου με ρόδες  
outdoor bin with wheels  
110 lt  
58x52x88 cm  
pack: 4

## καλάθια δωματίων CURVER



καλάθια δωματίου  
«My Style»  
29 cm | 33 cm

21.18667  
μπεζ  
29 cm | 33 cm  
pack: 1

21.18666  
καφέ  
29 cm | 33 cm  
pack: 1



καλάθια δωματίου  
«Jute»  
28x28 cm | 27 cm

21.45372  
μπεζ  
29 cm | 33 cm  
pack: 1



21.45715  
γκρι  
29 cm | 33 cm  
pack: 1



## «Knit» CURVER



21.30093  
καλάθι αχρήστων  
μπεζ,  
23,9x23,1 cm | 27,2 cm  
pack: 5



21.30094  
καλάθι αχρήστων  
καφέ,  
23,9x23,1 cm | 27,2 cm  
pack: 5



## «Chic Bin» CURVER



26.21046  
κάδος πεντάλ  
«Chic Bin M»  
coffe menu  
30-35 lt  
26,5x40,5 cm | 45 cm  
pack: 4



26.21049  
κάδος πεντάλ  
«Chic Bin L»  
coffe menu  
50-60 lt  
29x44,5 cm | 60,5 cm  
pack: 3

## κάδοι «Swing Top» CURVER



21.67910  
κάδος, γρανίτς  
10 lt  
24,6x19,8 cm | 37,3 cm  
pack: 6



21.67908  
κάδος, γρανίτς  
15 lt  
30,6x24,8 cm | 41,8 cm  
pack: 6



21.68013  
κάδος, γρανίτς  
25 lt  
34,6x27,8 cm | 51,1 cm  
pack: 4



21.67909  
κάδος, ασημί  
50 lt  
40,6x34 cm | 66,8 cm  
pack: 3



## «Bullet roll top» CURVER



21.55303  
κάδος ανθρακί  
10 lt  
25,4x25,4 cm | 38,8 cm  
pack: 6



21.78045  
κάδος ανθρακί  
25 lt  
34x34 cm | 57 cm  
pack: 5



21.55301  
κάδος ανθρακί  
50 lt  
39,1x39,1 cm | 74 cm  
pack: 6

## κάδοι «Pacific flip» CURVER



21.86133  
κάδος ανθρακί/ασημί  
10 lt  
18,9x23,5 cm | 35 cm  
pack: 4



21.86157  
κάδος ανθρακί/ασημί  
25 lt  
26x34 cm | 47 cm  
pack: 4



21.86181  
κάδος ανθρακί/ασημί  
50 lt  
29,4x37,6 cm | 65,3 cm  
pack: 4

	<p>26.21051 κάδος απορριμμάτων «Comratta», γκρι, 38x28 cm   43 cm pack: 5</p>		<p>26.21059 κάδος απορριμμάτων «Koral Bin S» λευκός, 10 lt 19x24 cm   28 cm pack: 6</p>		<p>26.21041 κάδος απορριμμάτων «Chic Bin S Steel» ασημί, 10 lt 17x27 cm   30 cm pack: 5</p>
					<p>26.21045 κάδος απορριμμάτων «Chic Bin M Steel» ασημί, 35 lt 26,5x40,5 cm   45 cm pack: 4</p>
					<p>26.21048 κάδος απορριμμάτων «Chic Bin L Steel» ασημί, 50 lt 29x44,5 cm   60,5 cm pack: 3</p>
					<p>26.21074 κάδος απορριμμάτων «Chic Bin Parika» κόκκινος, 35 lt 26,5x40,5 cm   45 cm pack: 4</p>

	<p>λεκάνες «Essentials» πετρόλ 21.35198 12 lt - 35x35 cm pack: 8</p>		<p>μπολ ανάμειξης «Essentials» λευκό 21.21928 2,5 lt 23x21 cm   12,2 cm pack: 1/6</p>		<p>21.23899 πιατοθήκη παραλ/μη λευκή 39,1x29 cm   10,9 cm pack: 1/5</p>
	<p>λεκάνες «Essentials» πετρόλ 21.35207 6 lt - 30 cm pack: 8</p>		<p>21.21924 3,5 lt 26x23,3 cm   15,2 cm pack: 1/6</p>		<p>21.23900 πιατοθήκη παραλ/μη γκρι 39,1x29 cm   10,9 cm pack: 1/5</p>
	<p>21.35225 10 lt - 36 cm pack: 8</p>		<p>21.21933 σουρωτήρι μεγάλο λευκό 28x23,5 cm   13,4 cm pack: 1/6</p>		<p>21.23903 πιατοθήκη τετράγωνη, λευκή 39,1x39,1 cm   10,9 cm pack: 1/5</p>
	<p>21.59422 λεκάνη στρογγυλή, γρανίτς 32 cm   14 cm pack: 5</p>		<p>21.73460 πιατοθήκη με δίσκο ανθρακί 45x38 cm pack: 1/10</p>		<p>21.23904 πιατοθήκη τετράγωνη, γκρι 39,1x39,1 cm   10,9 cm pack: 1/5</p>



κάθισμα «Κnit»



26.00023  
κάθισμα σε χρώμα καφέ  
57 cm | 31,4 cm  
pack: 1

τραπέζακι «Κnit»  
με αποθηκευτικό χύδρο



26.00025  
σε χρώμα καφέ  
40,6 cm | 41,3 cm  
pack: 1



26.00024  
κάθισμα σε χρώμα μπεζ  
57 cm | 31,4 cm  
pack: 1



26.00026  
σε χρώμα μπεζ  
40,6 cm | 41,3 cm  
pack: 1

οκαμπό  
«Cozy»

26.00134  
οκαμπό καφέ  
35 cm | 66 cm  
pack: 1



26.00133  
οκαμπό καφέ  
35 cm | 44 cm  
pack: 1



26.00169  
κάθισμα σε χρώμα γκρι  
57 | 31,4 cm  
pack: 1



26.00170  
σε χρώμα γκρι  
40,6 cm | 41,3 cm  
pack: 1

HORECA  
 PROFESSIONAL EQUIPMENT  
 544  
 ΕΠΙΠΛΑ



CURVER

κουτιά αποθήκευσης



21.43403  
«XS cube», 3 lt  
17x17 cm | 12 cm  
pack: 6

«Beton»



21.43398  
«Beton» XS cube»  
με καπάκι, 2 lt  
17x17 cm | 13 cm  
pack: 6



21.43399  
«Beton» S rect.  
με καπάκι, 2 lt  
24x17 cm | 13 cm  
pack: 6



21.96823  
«M cube», 8 lt  
45x25 cm | 12 cm  
pack: 6



26.10016 Ξαπλώστρα Jaiur  
σε χρώμα γραφίτη  
187,5x58,2x29cm  
pack: 1



Ο γέιτς στην αγορά πλάστικων υποδείγων και αποθηκευτικών λύσεων εξωτερικού χώρου. Η δογική πίσω από κάθε προϊόν Keter είναι η βεδίωση της καθημερινότητας των ανθρώπων. Όδα τα προϊόντα της προσφέρουν πραγματικές λύσεις με απλές φόρμες. Διακρίνονται για την υψηλή τους ποιότητα και υποστηρίζονται με εγγυήσεις. Σεβόμενη το περιβάλλον κατασκευάζει τα προϊόντα της από 100% ανακυκλώσιμο ποδυπροπυλένιο.



«Cool Bar»

τραπεζάκι/κάθισμα/ψυγείο «Cool Bar»  
49,5 cm | 57 cm

26.00150  
γκρι/άσπρο  
pack: 1

26.00157  
άσπρο/γκρι  
pack: 1



«Breeze bar»

26.00166  
τραπεζάκι/ ψυγείο  
«Breeze bar» καφέ  
83x40,5 cm | 74 cm (60 lt)  
pack: 1



τραπεζάκι/κάθισμα/ψυγείο «Cool Stool»  
43,7cm | 44,3 cm

«Cool Stool»

26.00163  
σε χρώμα γραφίτη  
pack: 1

26.00022  
σε χρώμα καφέ  
pack: 1







«Emma»



«Emily»

«Emily»

KETER



26.10134  
σετ «Emily» lounge  
χρώμα ανθρακί  
καναπές: 68x111 cm | 75 cm  
καρέκλες: 68x64 cm | 75 cm  
τραπέζι: 47x65 cm | 42 cm  
pack: 1

«Emma»

KETER



26.10133  
σετ «Emma»  
χρώμα γραφίτης  
διθέσιος καναπές: 113x65 cm | 74 cm  
πολυθρόνες: 65x63 cm | 74 cm  
τραπέζι: 58,5x58,5 cm | 43 cm  
pack: 1

«Orlando»

26.10081  
lounge set «Orlando», γραφίτης  
3 θέσιος καναπές: 126x64,5x75,5 cm  
πολυθρόνα: 64,5x64,5x75,5 cm  
τραπέζι: 78x58,5x43 cm  
pack: 1

KETER





KETER

26.00012  
μπουφές «Unity»  
γραφίτης  
70x54 cm | 90 cm  
pack: 1



26.10015  
σετ μπαλκονιού «Salemo», καφέ  
τραπέζι: 39x39 cm | 43 cm  
πολυθρόνα: 75x66,5 cm | 76 cm  
pack: 1

«Salemo»

KETER



26.10076  
τραπέζι «Futura»  
sarruccino  
165x94 cm | 74 cm  
pack: 1



26.10079  
καρέκλα «Dante»  
sarruccino  
57x57 cm | 79 cm  
pack: 1



26.10074  
τραπέζι «Futura»  
γραφίτης  
165x94 cm | 74 cm  
pack: 1



26.10075  
καρέκλα «Dante»  
γραφίτης  
57x57 cm | 79 cm  
pack: 1





## «Style rattan»

26.00122  
σετ 2 γλάστρες «Style rattan»  
small+medium, κυλινδρικές,  
καφέ  
pack: 1



KETER

26.00118  
γλάστρα γκρι, 3,2 lt  
28 cm | 18 cm  
pack: 1

## «Knit»



26.00117  
γλάστρα μωβ, 3,2 lt  
28 cm | 18 cm  
pack: 1



## «Springwood»

KETER

VEO  
VIBRANT



26.00149  
μπαούλο «Comfy», 305 lt, γραφίτης  
123x54 cm | 57 cm  
pack: 1



## «Kentwood»

KETER

VEO  
VIBRANT



26.00171  
μπαούλο «Kentwood», 350 lt, καφέ  
128x54 cm | 59 cm  
pack: 1

## «Circa»

KETER

26.00007  
μπαούλο «Circa», rattan, καφέ  
68x68 cm | 43,5 cm  
pack: 1



KETER

## «Comfy»

26.00129  
μπαούλο «Comfy», 270 lt, γαφίτης  
117x45 cm | 57 cm  
pack: 1



KETER

## «Sumatra»

26.00067  
μπαούλο «Sumatra»  
με μηχανισμό αυτόματου ανοίγματος  
με δύο θήκες, λευκό, 615 lt  
145x73 cm | 64 cm  
pack: 1



## **Inox 18/10 - Ανοξείδωτο 18/10**

Η σύνθεσή του είναι: χρώμιο 18%, νικέλιο 10% και σίδηρο 72%. Έχει πολύ μεγάλη αντοχή στη σκουριά. Είναι εύκολο στο δίπλωμα, το λύγισμα και το σταμπάρισμα. Το χρώμα του δεν μεταβάλλεται. Δεν θαμπώνει και αντέχει στο χρόνο. Η επιφάνειά του είναι λεία χωρίς πόρους καθώς και ανθεκτική στα χτυπήματα με αποτέλεσμα να μην χαράζει. Δεν έλκεται από μαγνήτη και αντέχει στις υψηλές θερμοκρασίες (κρύο-ζέστη). Είναι ιδανικό για χρήση σε χώρους μαζικής εστίασης.

## **Inox 18/0 - Ανοξείδωτο 18/0**

Ίδια σύνθεση με το 18/10 αλλά χωρίς πρόσμιξη νικελίου. Έχει παρόμοιες ιδιότητες με 18/10 αλλά παρουσιάζει μερική ευαισθησία στην υγρασία. Έχει ανάγκη μεγαλύτερης φροντίδας (άμεσο σκούπισμα μετά το πλύσιμο). Έλκεται από το μαγνήτη.

## **Polycarbonate (PC)**

Διαφανές πλαστικό, πολύ καλής ποιότητας. Έχει στιλπνή επιφάνεια, προσδίδοντας κρυστάλλινη αίσθηση, δεν προσβάλλεται από οξέα, καθαρίζεται εύκολα, έχει υψηλή αντοχή στα χτυπήματα, είναι άκαμπτο και αντέχει σε θερμοκρασίες από  $-40^{\circ}\text{C}$  έως  $+100^{\circ}\text{C}$ . Ιδανικό για χρήση σε χώρους μαζικής εστίασης. Η τιμή του είναι 4 φορές υψηλότερη από εκείνη του Polyethylene.

## **Tritan (BPA free)**

Το Tritan είναι πλαστικό πολυμερές. Δεν περιέχει δισφαινόλη S (BPS) και δισφαινόλη A (BPA). Είναι απαλλαγμένο από οιστρογονική και ανδρογονική δράση. Είναι απολύτως ασφαλές και γι' αυτό χρησιμοποιείται στην κατασκευή μπουκαλιών νερού, κ.ά.

## **Polyethylene (PE)**

Πλαστικό 2 τύπων, χαμηλής και υψηλής πυκνότητας. Χαμηλής πυκνότητας: χρησιμοποιείται σε υψηλές και χαμηλές θερμοκρασίες, είναι αρκετά εύκαμπτο, χάνει τη φόρμα του στο πολύ βάρος. Υψηλής πυκνότητας (HD): είναι περισσότερο εύθραυστο στις χαμηλές θερμοκρασίες από το χαμηλής πυκνότητας, αλλά πιο στερεό και πιο ανθεκτικό στο βάρος. Για θερμοκρασίες:  $-20^{\circ}\text{C}$  έως  $+80^{\circ}\text{C}$ .

## **Polyrattan**

Μεταποιημένο υλικό ύφανσης από Polyethylene.

## **Polypropylene (PP)**

Πλαστικό γαλακτώδες, ημιδιαφανές, όχι γυαλιστερό, αρκετά εύκαμπτο και ανθεκτικό. Αντέχει σε θερμοκρασίες από  $-20^{\circ}\text{C}$  έως  $+90^{\circ}\text{C}$ . Δεν μπαίνει στο φούρνο μικροκυμάτων.

## **Polystyrene (PS)**

Πλαστικό διαφανές, γυαλιστερό, άκαμπτο, εύθραυστο. Αντέχει σε θερμοκρασίες από  $-20^{\circ}\text{C}$  έως  $+80^{\circ}\text{C}$ . Δεν μπαίνει στον φούρνο μικροκυμάτων.

## **Melamin (MF - Μελαμίνη)**

Οργανική ένωση, αδιαφανής, άφλεκτη, με χρώμα λαμπερό, σκληρή και με μεγάλη αντοχή. Είναι ασφαλής για τρόφιμα, άγευστη και άοσμη και με μηδαμινή τοξικότητα. Ακατάλληλη για μαγείρεμα/τηγάνισμα και για χρήση σε φούρνο μικροκυμάτων. Αντοχή σε θερμοκρασίες από  $-30^{\circ}\text{C}$  έως  $+70^{\circ}\text{C}$ .

## **Plexyglass (PG)**

Συνθετικό πολυμερές, διάφανο που χρησιμοποιείται σαν εναλλακτική χρήση αντί του γυαλιού. Κατάλληλο για τρόφιμα. Αντοχή σε θερμοκρασίες από  $0^{\circ}\text{C}$  έως  $+70^{\circ}\text{C}$ .

## **PVC (Πολυβινυλοχλωρίδιο)**

Είναι ένα πλαστικό πολυμερές που διαθέτει χημική αντοχή και αναφλέγεται δύσκολα. Αντέχει σε θερμοκρασίες  $-25^{\circ}\text{C}$  έως  $+70^{\circ}\text{C}$ .

## **SAN (Styrene Acrylonitrile)**

Διάφανο υλικό με μεγάλη αντοχή στη θερμότητα, ανθεκτικό στις κρούσεις και δεν λυγίζει. Δεν προσβάλλεται εύκολα από τα οξέα και αντέχει σε θερμοκρασίες  $-10^{\circ}\text{C}$  έως  $+70^{\circ}\text{C}$ .

## **Fiber glass**

Ίνες γυαλιού περασμένες με ρητίνη. Ελαφρύ υλικό με μεγάλη αντοχή.

## **Carbon fiber**

Ίνες άνθρακα περασμένες με ειδική ρητίνη. Υλικό με εκπληκτική αντοχή και χαμηλό βάρος που αντέχει σε υψηλές θερμοκρασίες.

## **Σιλικόνη**

Οι σιλικόνες είναι αδρανείς, συνθετικές ενώσεις, με ποικιλία μορφών και χρήσεων. Είναι πολυμερή που περιέχουν πυρίτιο μαζί με άνθρακα, υδρογόνο, οξυγόνο και κάποιες φορές και άλλα στοιχεία. Ως υλικά χαμηλής μόλυνσης και μη τοξικές, οι σιλικόνες μπορούν να χρησιμοποιηθούν όπου απαιτείται επαφή με τροφή. Τα σκεύη από σιλικόνες γίνονται όλο και περισσότερο σημαντικά προϊόντα στη βιομηχανία σκευών μαγειρικής και ψισίματος.

### Slate (Σχιστόλιθος)

Πέτρωμα με φύλλωση (λεπτά φύλλα) που αποτελείται κυρίως από ορυκτό χαλαζία και μοσχοβίτη ή ιλλίτη. Είναι υδατοστεγές (νερό, λάδι, χυμοί, κ.ά.), ανθεκτικό στην ψύξη και στις υψηλές θερμοκρασίες. Με ειδική επεξεργασία που το καθιστά καταλληλότερο για τα τρόφιμα (APS). Δεν μπαίνει στο πλυντήριο πιάτων.

### BORO (Borosilicate glass - Βιοπυριτικό γυαλί)

Το βιοπυριτικό γυαλί είναι ένα είδος γυαλιού που περιέχει διοξείδιο του πυριτίου και τριοξείδιο του βορίου. Είναι ανθεκτικότερο στο θερμικό σοκ. Χρησιμοποιείται για την κατασκευή γυάλινων σκευών και υψηλής ποιότητας ποτηριών - δοχείων ποτών. Μπαίνει στο πλυντήριο και στο φούρνο μικροκυμάτων.



### NSF (National Sanitation Foundation)

Είναι ένας οργανισμός που η αποστολή του εστιάζεται στην προστασία και τη βελτίωση της παγκόσμιας υγείας. Το σήμα NSF πιστοποιεί ότι το προϊόν που το φέρει εναρμονίζεται με όλες τις προκαθορισμένες απαιτήσεις του πρωτοτύπου.

### Induction

Οι ηλεκτρικές εστίες induction χρησιμοποιούν την ηλεκτρομαγνητική επαγωγή για να θερμάνουν ηλεκτρικά αγωγίμες σκευές. Η θερμοκρασία αναπτύσσεται μέσα στο ίδιο το σκεύος, οπότε ο χρόνος του μαγειρέματος συντομεύει. Το μαγείρεμα σε εστίες induction γίνεται οικονομικότερο, η διαδικασία του μαγειρέματος ελέγχεται αποτελεσματικότερα και παρέχεται μεγαλύτερη ασφάλεια από κάθε άλλο γνωστό μέσο, π.χ. ηλεκτρικές κουζίνες, γκάζι, κ.ά.

Πρέπει, όμως, να χρησιμοποιηθούν τα κατάλληλα για induction σκεύη. Σήμερα, όλα τα inox 18/10 σκεύη είναι κατάλληλα για εστίες induction, όπως τα δικά μας HENDI και MEGA. Στον κατάλόγο μας θα βρείτε επίσης διάφορα σκεύη κατάλληλα για εστίες induction, καθώς και τηγάνια των εταιριών DeBuyer, Hendi, Spring κατασκευασμένα από inox και από άλλα υλικά όπως αλουμίνιο, χαλκό ή σίδηρο.

### HACCP HACCP (Υγειονομικός κανονισμός)

Οι Ευρωπαϊκοί κανονισμοί που αφορούν στην υγιεινή των τροφίμων έχουν ως πρωταρχικό στόχο την προστασία της δημόσιας υγείας. Στους χώρους μαζικής εστίασης προβλέπονται αυστηροί έλεγχοι σε κάθε φάση της διατροφικής αλυσίδας όπου υπάρχει κίνδυνος μόλυνσης.

## εγγυήσεις



### Edge chip warranty

Πενταετής εγγύηση για το ξεφλούδισμα του χείλους των πιάτων (edge chipping) που καλύπτει όλα τα προϊόντα όλων των σειρών που παρασκευάζονται στο εργοστάσιο Stoke-on-Trend της Αγγλίας.

Βασική προϋπόθεση για την εφαρμογή της ανωτέρω εγγύησης είναι η εξέταση και έγκριση των πιατικών από εκπρόσωπο της εταιρίας PKS HENDI SOUTH EAST EUROPE S.A. Η επίσημη εγγύηση, η οποία και θα πρέπει να κατατίθεται στην Dudson εντός 60 ημερών από την ημερομηνία τιμολόγησής σας από την εταιρία PKS HENDI SOUTH EAST EUROPE S.A., είναι στη διάθεσή σας.



### XTRATUFF

Xtratuff: είναι η μέθοδος που χρησιμοποιεί η Onis για να προσδώσει extra αντοχή στο πάνω μέρος των ποτηριών.

Πρόκειται για θερμική επεξεργασία στο τελευταίο στάδιο της παραγωγής του ποτηριού. Εφαρμόζεται σε καθιστά ποτήρια όπως η σειρά Gibraltar, Everest, Endeavor κ.ά.



### Διατήρηση μαχαίροπύρουνων

Για να έχετε καλοδιατηρημένα τα μαχαίροπύρουνά σας η HEPP αναλαμβάνει να τα επεξεργαστεί και να γίνουν όμορφα σαν την πρώτη ημέρα. Επεξεργασίες της επιφάνειας των μαχαίροπύρουνων: στίλβωση, ματ φινιρισμα ή αμβροβλή, ανανέωση των οδοντωτών μαχαίρων, ετικέτες με λέιζερ, σφράγιση, χαρακτηριστική καθώς και χάραξη.

## Ποτηριών

Χωρίς αμφιβολία, τα ποτήρια είναι μια μεγάλη επένδυση. Για να τα διατηρήσουμε εν ζωή χρειάζονται φροντίδα και προσοχή στη χρήση. Δύο είναι οι πιο κοινές αιτίες απώλειας των ποτηριών: το μηχανικό και το θερμικό σοκ. Οι συμβουλές που ακολουθούν θα σας βοηθήσουν να ελαχιστοποιήσετε τους κινδύνους απώλειας των ποτηριών σας.

### Θερμικό σοκ

Το θερμικό σοκ είναι αποτέλεσμα της απότομης αλλαγής θερμοκρασίας στο εσωτερικό του ποτηριού.

Το γυαλί συγκρατεί μέσα του μια συγκεκριμένη θερμοκρασία και η οποιαδήποτε απότομη αλλαγή αυτής της θερμοκρασίας δημιουργεί στα εσωτερικά του τοιχώματα αρκετή πίεση, ώστε να προκληθεί το σπάσιμό του.

Παράδειγμα: Όταν βάζουμε ένα ποτήρι που περιέχει παγάκια κατευθείαν στο πλυντήριο ή το αντίθετο, όταν βάζουμε παγάκια ή παγωμένο νερό σε ένα ποτήρι που μόλις έχει βγει από το πλυντήριο και είναι ζεστό. Και στις δυο περιπτώσεις, το ποτήρι πρέπει να επανέλθει στη θερμοκρασία του περιβάλλοντος χώρου πριν δεχθεί την αντίθετη θερμοκρασία από αυτήν που έχει. Όσο, δε, πιο βαρύ και παχύ είναι το ποτήρι, τόσο περισσότερος χρόνος χρειάζεται για να επανέλθει στη θερμοκρασία του περιβάλλοντος. Τα ραγίσματα που δημιουργούνται από το θερμικό σοκ, συνήθως συσσωρεύονται γύρω από «μικροτραύματα» που έχουν ήδη δημιουργηθεί από μηχανικά σοκ, αυξάνοντας έτσι τις πιθανότητες σπασίματος ενός ποτηριού - το οποίο συνήθως συμβαίνει ξαφνικά και χωρίς φανερό αιτία κατά τη διάρκεια του σερβιρίσματος.

### Μηχανικό σοκ

Μηχανικό σοκ υφίστανται τα ποτήρια που έρχονται σε απευθείας επαφή με άλλα αντικείμενα, όπως μαχαιροπίρουνα, πιατικά ή άλλα ποτήρια.

Αυτό το είδος επαφής (μικρής σύγκρουσης) μπορεί να προκαλέσει στο ποτήρι «ζημιά» που δεν είναι ορατή αλλά ικανή να το καταστήσει ευάλωτο στο σπάσιμο, είτε από επαφή με άλλο αντικείμενο, είτε από θερμικό σοκ.

### Μικρές συμβουλές

1. Πρέπει να διαθέτετε επαρκή αριθμό ποτηριών ώστε τα ποτήρια που μόλις πλύθηκαν να έχουν θερμοκρασία περιβάλλοντος πριν χρησιμοποιηθούν στο σερβίρισμα.
2. Ελέγχετε δύο φορές την ημέρα τη θερμοκρασία του πλυντηρίου σας. Δεν πρέπει να ξεπερνά τους 55°C. Συστηματικό πλύσιμο σε υψηλότερη θερμοκρασία θα θολώσει τα ποτήρια σας.
3. Χρησιμοποιείτε πάντα τη σωστή δόση απορρυπαντικού.
4. Συμβουλευτείτε το προσωπικό να μειώσει το θόρυβο κατά τη διάρκεια του σερβιρίσματος. Η ησυχία συμβάλλει όχι μόνο στη δημιουργία ενός ευχάριστου περιβάλλοντος αλλά και στην αποφυγή μηχανικών σοκ (λιγότερα σπασίματα αργότερα).
5. Χρησιμοποιείτε τα κατάλληλα ποιοτικά καλάθια για τα ποτήρια σας. Υπάρχει αντίστοιχο καλάθι για το κάθε μέγεθος ποτηριού.
6. Τα ποτήρια δεν πρέπει να πλένονται μαζί με άλλα είδη όπως μαχαιροπίρουνα, κατσαρόλες και πιατικά. Αλλά ούτε και μεταξύ τους ποτήρια ανόμοιου μεγέθους σε ανοιχτό καλάθι χωρίς χωρίσματα.
7. Ρυθμίστε την πίεση του νερού του πλυντηρίου να είναι μεταξύ 3 και 6 bar. Εάν είναι μεγαλύτερη, πρέπει να εγκατασταθεί ένας μειωτήρας πίεσης, έτσι ώστε τα ποτήρια να μην «χοροπηδούν» κάτω από την πίεση του νερού.

## Ξύδινων σκευών

- Πλύσιμο στο χέρι με ήπιο απορρυπαντικό. Ξεβγάλτε κάτω από τη βρύση και μην το αφήνετε μέσα στο νερό να μουλιάσει γιατί θα δημιουργηθεί πρόβλημα στο σκεύος
- Αμέσως σκουπίστε καλά με ένα καθαρό πανί και αφήστε το να στεγνώσει καλά.
- Μην το αφήνετε εκτεθειμένο στο φως του ήλιου.
- Για όσο διάστημα δεν χρησιμοποιείτε το σκεύος αποθηκεύστε το σε μέρος ξηρό και δροσερό.
- Περάστε με λάδι εάν το ξύλο φαίνεται πολύ ξηρό.
- Ανάλογα με τον τύπο του ξύλου χρησιμοποιείτε το κατάλληλο λάδι: π.χ. για ξύλο Ακακίας φυτικό λάδι, για ξύλο Ελιάς ελαιόλαδο, ξύλο bambou λάδι καρύδας ή ορυκτέλαιο.

### Πλύσιμο

- Χρησιμοποιείτε πλαστικές ή λαστικένιες σπάτουλες για να αδειάσετε το περιεχόμενο των πιάτων, ποτέ μεταλλικά, αιχμηρά εργαλεία ή σκληρά σφουγγάρια.
- Πλένετε καλά τα πιάτα μετά τη χρήση.
- Χρησιμοποιείτε πάντα πλαστικά καλάθια στο πλύσιμο και κατά προτίμηση καλάθια με χωρίσματα ούτως ώστε οι λαβές των φλιτζανιών ή τα στόμια των λοιπών εξαρτημάτων να μην χτυπούν μεταξύ τους.
- Μην πλένετε ποτέ σκεύη πορσελάνης μαζί με μεταλλικά.
- Αποφύγετε, όποτε μπορείτε, την κακοποίηση της υάλωσης. Δεν πρέπει τα πιάτα να τριβονται και να χτυπιούνται μεταξύ τους.
- Δυνατά απορρυπαντικά ή μεγάλες δόσεις απορρυπαντικών θα επηρεάσουν χρυσές, πλατινένιες διακοσμώσεις και θα επιτεθούν στην επιφάνεια της υάλωσης.
- Εάν υπάρχουν λεκέδες στην υάλωση, χρησιμοποιείτε το κατάλληλο καθαριστικό ή αφήστε τα πιάτα μέσα σε ελαφρύ διάλυμα νερού με λευκαντικό. Ποτέ μην χρησιμοποιείτε σκληρά αντικείμενα για να αφαιρέσετε τον λεκέ. Μερικά απορρυπαντικά μπορούν να επηρεάσουν και να γίνουν αιτία εμφανίσεως λεκέδων. Εάν ο λεκές παραμένει, επικοινωνήστε μαζί μας.

### Αποθήκευση και διαχείριση

- Έχετε πάντα το κατάλληλο απόθεμα πιάτων ώστε να γίνει το σωστό «γύρισμα». Με προσεκτικό χειρισμό θα παρατείνετε την ζωή των πιατικών σας και το κόστος αντικατάστασης θα είναι πάρα πολύ χαμηλό. (Κάθε

πιάτο θα πρέπει να αριθμεί τουλάχιστον τρεις φορές τα καθίσματα του εστιατορίου σας).

- Προσπαθείτε όσο δυνατόν να τα αποθηκεύετε σε κατάλληλα δοχεία ή σε ράφια αντί να τα στοιβάζετε. Αποθηκεύετε το κάθε είδος μόνο του. Μερικά αποθηκεύονται τέλεια στα καλάθια που πλένονται.
- Ποτέ μην τα χτυπάτε μεταξύ τους ή πάνω στους πάγκους. Όσο λιγότερα και ελεγχόμενα είναι τα χτυπήματα, τόσο περισσότερο θα αντέξουν τα πιατικά σας.
- Η υάλωση των πιατικών είναι πολύ σκληρή. Όταν τριβονται με μαλακά μέταλλα, τότε, στοιχεία των μετάλλων κολλούν στην επιφάνειά τους. Αυτό αποκαλείται μεταλλικό σημάδι (metal marking). Το αλουμίνιο «γράφει» πάνω στην υάλωση όπως και το ανοξείδωτο, ανάλογα με τη σκληρότητά του.
- Όπως το διαμάντι κόβει το διαμάντι έτσι και η υάλωση χαράζει την υάλωση! Χρειάζεται μεγάλη φροντίδα στο χειρισμό των πιατικών σας.
- Αποφύγετε τις απότομες αλλαγές θερμοκρασίας (thermal shocks) που μπορούν να ραγίσουν τα πιατικά. Από τον καυτό φούρνο σε κρύα επιφάνεια, από το ψυγείο στον καυτό φούρνο, χρήση πάνω σε φλόγα ή ηλεκτρικό μάτι.

### Διακοσμώσεις από χρυσό ή πλατίνα

- Συνήθως αυτές οι διακοσμώσεις γίνονται πάνω στην υάλωση. Επομένως δεν παρέχεται εγγύηση.
- Μην τοποθετείτε ποτέ πιατικά που φέρουν διακόσμηση ευγενούς μετάλλου σε φούρνο μικροκυμάτων.

### μαχαιροπίρουνων

- Τα μαχαιροπίρουνα πρέπει να πλένονται αμέσως μετά τη χρήση τους. Ιδιαίτερα τα μαχαίρια, πρέπει να πλένονται με μαλακό σφουγγάρι. Εάν πλένονται στο πλυντήριο, πρέπει να χρησιμοποιείτε πλαστικό καλάθι. Τα μαχαίρια πρέπει να πλένονται με την λάμα προς τα πάνω.
- Μην πλένετε στο ίδιο καλάθι τα μαχαίρια με τα κουτάλια και τα πιρούνια και ποτέ με άλλα μεταλλικά σκεύη.
- Μην χρησιμοποιείτε απορρυπαντικό με χλώριο. Θα πρέπει, δε, το απορρυπαντικό να είναι κατάλληλο για μαχαιροπίρουνα. Επίσης θα πρέπει να προσέχετε πάντοτε τη δοσολογία.

- Μετά το πλύσιμο, τα μαχαιροπίρουνα θα πρέπει να σκουπίζονται με μαλακό πανί. Ακόμη και αν το πλυντήριο διαθέτει αυτόματο πρόγραμμα στεγνώματος θα πρέπει οπωσδήποτε να σκουπίσετε τα μαχαίρια.

- Φυλάσσετε τα μαχαιροπίρουνα σε μη μεταλλική θήκη. Προστατέψτε τα μαχαίρια από την υγρασία. Ως γνωστό, τα μαχαίρια δεν είναι από 18/10 ανοξείδωτο μέταλλο όπως τα κουτάλια και τα πιρούνια, οπότε είναι ευαίσθητα στην παρατεταμένη επαφή με το νερό (υπάρχει χλώριο), με τα οξέα φαγητών, την υγρασία, τα σκληρά απορρυπαντικά.



## τηγάνια steel

Καλύψτε την επιφάνεια του τηγανιού με λάδι και ζεστάνετε μέχρι να εμφανιστεί καπνός. Αδειάστε το λάδι και σκουπίστε το τηγάνι σας με χαρτί κουζίνας. Όσο περισσότερο χρησιμοποιείτε το τηγάνι τόσο βελτιώνεται η απόδοση του. Το σκούρο χρώμα που αποκτά από την συχνή χρήση δίνει στο τηγάνι φυσικές αντικολητικές ιδιότητες.

### Χρήση:

Ζεστάνετε μια μικρή ποσότητα λαδιού στο τηγάνι και μόλις αυτό ζεσταθεί καλά, τοιγαρίστε το φαγητό και από τις δύο πλευρές για περίπου 45 δευτερόλεπτα από την κάθε μία και μετά χαμηλώστε τη φωτιά έως ότου ολοκληρωθεί το μαγείρεμα. Μην αφήνετε το φαγητό στο τηγάνι μετά το μαγείρεμα.

Καθαρισμός μετά από κάθε χρήση:

- Πλύνετε το τηγάνι με πολύ ζεστό νερό και ένα σφουγγάρι. Σκουπίστε καλά χρησιμοποιώντας ένα απορροφητικό πανί.
- Περιοδικά καθαρίστε το τηγάνι τοποθετώντας μαγειρικό αλάτι και ζεσταίνοντας το στην εστία σε

υψηλή θερμοκρασία για ενάμιση λεπτό. Σκουπίστε καλά χρησιμοποιώντας ένα απορροφητικό πανί. Το αλάτι βοηθάει στην εξάλειψη τυχόν υπολειμμάτων και οσμών προηγούμενων μαγειρεμάτων.

- Απλώστε λάδι με χαρτί κουζίνας στην επιφάνεια του τηγανιού και φυλάξτε το σε στεγνό μέρος.

### Προειδοποίηση!

Μην αφήνετε το τηγάνι σας να μουλιάσει. Σε περίπτωση που υπολείμματα φαγητού κολλήσουν στο τηγάνι, χρησιμοποιήστε πράσινο σφουγγάρι. Δεν πλένεται σε πλυντήριο πιάτων. Το τηγάνι μπορεί να εμφανίσει σκουριά εάν δεν ακολουθούνται οι οδηγίες. Στην περίπτωση αυτή τρίψτε το τηγάνι με μια σκληρή βούρτσα μέχρι να φύγει η σκουριά. Το μαγείρεμα τροφών που περιέχουν οξέα -ντομάτες, λευκό κρασί, λεμόνι- ενδεχομένως να επιφέρει αλλοιώσεις (εμφάνιση λευκών λεκέδων) στην επιφάνεια του τηγανιού. Στην περίπτωση που παρατηρήσετε κάτι τέτοιο, θα πρέπει να επαναλάβετε τη διαδικασία που ακολουθήσατε πριν από την πρώτη χρήση του σκεύους.

## αντικολλητικά τηγάνια

- Πριν την πρώτη χρήση πλύντε καλά το τηγάνι με ζεστό νερό.
- Μην υπερθερμαίνετε ποτέ το τηγάνι. Μέγιστη θερμοκρασία 250°C.

- Μην αφήνετε ποτέ άδειο το τηγάνι πάνω σε εστία που βρίσκεται λειτουργία.
- Μην χρησιμοποιείτε πολύ αιχμηρά ή μεταλλικά εργαλεία (κουτάλες, σπάτουλες, κ.ά).

**α**

amuse bouche .....273  
 αεριστής κρασιού.....363  
 ακονιστήρι μαχαιριών.....453  
 ακρυλική κανάτα.....364-365  
 αλατιέρα-πιπεριέρα.....14, 21, 68, 79, 81, 83, 88, 216, 312  
 αμπούλα σιφόν .....339, 377  
 αναδευτήρας bag spoon.....336  
 αναλόγιο συνεδρίου .....518  
 αναπτύρας .....316  
 ανθοδοχείο.....315  
 ανοιχτήρι κονσέρβας.....466  
 ανοιχτήρι πώματος σερβιτόρου.....341  
 ανοιχτήρι φιάλης κρασιού .....341  
 αντικολλητικό σκεύος.....389-393  
 αντικολλητικό τηγάνι.....389-392  
 αντικολλητικοί δίσκοι ζαχαρ.....393  
 αξεσουάρ κρασιού .....362-363  
 απολεπιστής ψαριών .....454  
 αποφλοιωτής λαχανικών.....462  
 αυγοδάρτης.....412  
 αυγοθήκη.....24, 88  
 αυγοκόπτης.....466

**β**

βάζο τροφίμων γυάλινο.....282  
 βάση τούρτας.....276-277  
 βιτρίνα τυριών/αλλαντικών.....234  
 βυσσινοκαθαριστής.....462

**γ**

γαλατιέρα αντικολλητική.....377  
 γαλατιέρα inox.....374, 376, 377  
 γαλατιέρα αφρόγαλου inox.....377  
 γαλατιέρα πορσελάνης.....15-90, 102, 376  
 γάντια κουζίνας.....455  
 γιαουρτιού σταντ.....235  
 γιουβετσάκι.....307  
 γκρίλια.....394  
 γουδί.....340, 467  
 γουόκ (wok).....305, 307, 383, 391-392

**δ**

dash bottle .....340  
 διανεμητής cereal/muesli.....213, 235-236  
 διανεμητής γάλακτος.....213, 229, 235, 238  
 διανεμητής γιαουρτιού.....235  
 διανεμητής καφέ.....218

διανεμητής φρούτων.....345  
 διανεμητής χυμού.....213, 229, 235, 237-239  
 δίσκοι μελαμίνης.....233, 242, 252-275  
 δίσκος inox.....217, 240  
 δίσκος ζαχαροπλαστικής.....393  
 δίσκος κοπής.....456-457  
 δίσκος κοπής bag.....344  
 δίσκος κοπής ψωμιού .....242  
 δίσκος παρουσίασης inox.....234, 240  
 δίσκος πίτσας - φούρνου.....409  
 δίσκος σερβιρ. αντιολισθητικός.....322-325  
 δίσκος φούρνου αντικολλητικός.....393  
 δίσκος φυσικής πέτρας.....290-291  
 δίσκος ψυχόμενος.....234  
 δοσομετρητής bag .....341  
 δοσομετρητής ζαχαροπλαστικής.....419  
 δοχεία GN πορσελάνης.....283  
 δοχείο GN inox.....472-475  
 δοχείο GN polycarbonate.....481-487  
 δοχεία PC διάφανα.....486-487  
 δοχεία PP διάφανα.....488  
 δοχείο Store'n Pour.....339  
 δοχείο αποθήκ. τροφίμων.....480-489  
 δοχείο απορριμμάτων επιτραπέζιο.....314  
 δοχείο μαχαιροπίρουνων.....314  
 δοχείο μεταφοράς πάγου.....348  
 δοχείο μεταφοράς φαγητού.....492-500  
 (catering) ισοθερμικό.....  
 δοχείο μπαχαρικών.....374  
 δοχείο πεντάλ.....541-543  
 δοχείο σάλτσας.....224-225  
 δοχείο φύλαξης τροφίμων.....480-489

**ε**

επαγωγικά τηγάνια (induction).....384-391  
 επαγωγικές εστίες (induction).....220  
 έπιπλα κήπου.....544-549  
 εργαλεία κινεζικής μαγειρικής.....403, 467  
 εργαλείο bag.....332-345  
 εργαλείο διακόσμησης  
 λεμονιών/πορτοκαλιών.....343  
 εργαλεία ζαχαροπλαστικής.....404-439  
 εστίες induction.....220  
 εταζέρα σερβιρίσματος.....217

**ζ**

ζαχαριέρα bag.....376  
 ζαχαριέρα άχνης.....397  
 ζαχαριέρα για φακελάκια.....88, 376  
 ζαχαριέρα πορσελάνης.....8-123  
 ζυγαριά κουζίνας.....469

**η**

ηλεκτρική αντίσταση  
 chafing dish.....212, 218-220  
 ηλεκτρική επαγωγική εστία.....220

**θ**

θερμόμετρο induction.....470-471  
 θερμόμετρο κουζίνας.....470-471  
 θήκη μακαρονιών.....458  
 θήκη μαχαιροπίρουνων.....242, 326

**ι**

ισοθερμικά δοχεία.....492-500  
 ισοθερμικά δοχεία μεταφοράς.....492-499  
 ισοθερμικά κρασιού.....362  
 ισοθερμικά πάγου.....347, 357

**κ**

κάδος απορριμμάτων.....541-543  
 κάδος απορριμμάτων/σταχτοδοχείο.....541  
 κάδος κήπου.....541  
 κάδος πεντάλ.....541-543  
 καθαριστής μύλων.....460  
 καλάθι δωματίου.....542  
 καλάθι μαχαιροπίρουνων  
 για τρόλει.....327  
 καλάθι πλυντηρίου.....502-505  
 καλάθι ψωμιού.....243-245  
 καλαμάκια μεταλλικά.....334  
 καλαμάκια χάρτινα.....355  
 καλούπι πάγου/παγάκια.....349  
 κάλυμμα πώματος.....341  
 κανάτα γυάλινη/κρυστάλλινη.....364-365  
 κανάτα θερμός ανοξείδωτη.....375  
 κανάτα νερού inox.....364  
 κανάτα μεζούρα.....399  
 κανελιέρα.....374  
 καπάκι βιτρίνας.....234, 240  
 καπάκι καρπάνα.....233, 276-277, 322  
 καπάκι πιάτου.....322  
 καράφα.....364-366  
 κάρβινκ (carving station).....225

καρέκλες συνεδρίου.....	509-512
κατοαρόλα.....	297, 305, 308, 383-388
καφετιέρα espresso.....	374
καφετιέρα πορσελάνης.....	8-121
καφετιέρα σερβιρίσματος ίποχ.....	356, 374
κηροπήγιο.....	216, 316
κόπτης ζαχαροπλαστικής.....	410
κόπτης ζύμης.....	410
κόπτης λαχανικών.....	460-463
κόπτης ντομάτας.....	461
κορνέ ζαχαροπλαστικής.....	416-418
κόσκινο.....	397
κουβαδάκι πάγου.....	347
κουβάς μεζούρα.....	399
κούπες.....	8-121, 371
κουτάλα κουζίνας.....	400-401
κουτάλα σερβιρίσματος.....	286-287
κουτάλα σούπας.....	286-287
κουτάλι amuse bouche.....	270
κουτάλι διακόσμησης.....	420
κουτάλι λεμονάδας - γρανίτας.....	336
κουτάλι μεζούρα.....	398
κουτάλι μελιού.....	315
κουτάλι μόκας/espresso.....	182-206
κουτάλι παγωτού scoop.....	411
κουτάλι σαλάτας.....	286-287
κουτί για φακελάκια τοαγιού.....	374
κρεβάτι.....	526
κρεμέρα.....	8-121, 376

## Δ

λαβίδα για αγκάθια ψαριών.....	454
λαβίδα γλυκών.....	288
λαβίδα κουζίνας.....	403
λαβίδα λαχανικών/σαλάτας.....	288
λαβίδα μπουφέ.....	288
λαβίδα πάγου.....	347
λαβίδα σπαγγέτι.....	288
λαβίδα ψωμιού.....	288
λαδόξυδο.....	216, 312-313
λάμπα ρεσώ.....	316
λεκάνη πλυσίματος.....	543
λαχανοκόπτης.....	459-462

## Μ

μάντλερ (muddler).....	337
μαντολίνο.....	459

μαρμελάδας σταντ.....	235
μαρμίτα.....	382-386
μασάτι.....	453
μαχαίρι bar.....	344
μαχαίρι grapefruit.....	343
μαχαίρι steak/κρέατος.....	207-209
μαχαίρι αλλαντικών.....	441-453
μαχαίρι γενικής χρήσεως.....	441-453
μαχαίρι γιαπωνέζικο.....	445
μαχαίρι γύρου.....	447-449
μαχαίρι διακόσμησης.....	343
μαχαίρι κουζίνας.....	441-453
μαχαίρι παπαγαλάκι...344, 441, 445, 451	
μαχαίρι σεφ.....	441-450
μαχαίρι σούσι.....	445
μαχαίρι στρειδιών.....	454
μαχαίρι τυριού.....	289
μαχαίρι χρωματιστό «color coding».....	446-450
μαχαροπίρουνο ίποχ 18/10.....	182-209
μεζούρα bar (jigger).....	333-335
μεζούρα υλικών.....	398
μελαμίνες.....	250-275
μπλοκαθαριστής.....	343, 460
μπαντάς.....	449, 451-452
μπαρ κάντι (bar caddy).....	344
μπαρ ματ (bar mat).....	345
μπασιόνα.....	395
μπασιόνα ασπραδιών.....	395
μπάτς.....	452
μπεν μαρί (chafing dish).....	212, 218-220
μπεν μαρί κατοαρόλα.....	221
μπολ ανάμιξης.....	395
μπολ γυάλινα.....	280-281
μπολ μελαμίνης.....	250-271
μπολ μιας χρήσης.....	355
μπολ μπουφέ.....	250-275, 280-281
μπολ ξηρών καρπών.....	269-271
μπολ πορσελάνης.....	8-121, 283-284
μπουκάλι flair.....	339
μύλοι χορταρικών.....	460
μύλος αλατιού-πιπεριού.....	310-311
μύτη κορνέ.....	416-418

## Ξ

ξύλινα είδη.....	221, 230-231, 242, 246-249
ξύστρα ζύμης.....	410

## Ο

οδοντογλυφιδιέρα.....	8-121
-----------------------	-------

## Π

παγοδοχείο.....	347-348
παγοθραύστης.....	349, 363
πάγου κουβαδάκι.....	347
παλέτα αποθήκης.....	477
παιδικό κρεβάτι.....	539
πατατοκόπτης.....	461
πατητήρι καφέ (tamper).....	378
πένσα αστακού.....	289
πέτρινοι δίσκοι - πλατό.....	290-291
πατέλα ίποχ.....	240
πατέλα πορσελάνης.....	8-121, 283-285
πατέλες με πόδι.....	276-277
πίατο γυάλινο.....	277
πίατο μιας χρήσης.....	355
πίατο πορσελάνης.....	8-121
πίνακας ανακοινώσεων.....	540
πινέλο.....	411
προύνα κουζίνας.....	400
προύνα σερβιρίσματος.....	286-287
προύνα ψητού.....	224-225
προυνάκι φοντού.....	220
πιστόνι ζαχαροπλαστικής.....	419
πλάστος ζύμης.....	411
πλαστικοί κάδοι απορριμμάτων.....	541-543
πορσελάνη.....	8-121
πορτοκαλοκαθαριστής.....	343
ποτήρι amuse bouche.....	273
ποτήρι bar.....	126-179, 350-354
ποτήρι cocktail, margarita, martini.....	126-179
ποτήρι freddo.....	126-179
ποτήρι grappa.....	135, 136, 158
ποτήρι mixing.....	332, 337
ποτήρι sherry.....	126-179
ποτήρι stirring.....	337
ποτήρι tiki.....	350-354
ποτήρι ισοθερμικό.....	372-373
ποτήρι κρασιού/σαμπάνιας.....	126-179
ποτήρι μπύρας.....	126-179
ποτήρι παγωτού.....	178-179
ποτήρι πισίνιας.....	366, 367, 369
ποτηροθήκες.....	504-505
πρέσα λάιμ.....	338

πρέσα για μπιφτέκια.....	452	σταντ petit four .....	217	τρόλεϊ ορόφων.....	525-526, 530-531
πρέσα πατάτας.....	464	σταντ αριθμού.....	316	τρόλεϊ σερβιρίσματος .....	327-329
πρέσα σκόρδου .....	464	σταντ για φακελάκια .....	374	τρόλεϊ τυριών-γλυκών .....	327-329
πριόνι .....	452	σταντ γιαουριού.....	235	τσαγιέρα μαντεμένα .....	370
πυρίμαχα σκεύη πορσελάνης.....	307	σταντ δίσκων.....	278-279, 324	τσαγιέρα πορσελάνης.....	8-121
πώμα ροής.....	341	σταντ μπουκαλιών .....	363	τσαγιέρα σερβιρίσματος inox .....	356, 374
πώμα σαμπάνιας ή φιάλης.....	341	σταντ σαμπανιέρας.....	357-358	τσάφερς (chafer) .....	212, 218-220
<b>ρ</b>		σταντ φρούτων.....	241	τσάφερς (chafer) buid-in.....	220
ραμκέν.....	285, 301, 307	σταχτοδοχείο αντιανεμικό.....	346	τσάφερς (chafer)	
ράφια-ραφιέρες αποθήκευσης.....	478-479	σταχτοδοχείο ασφαλείας.....	346	induction.....	212, 218-220
ρεσώ κηροπήγια .....	216, 316	σταχτοδοχείο δαπέδου.....	541	τσέρκια ζαχαροπλαστικής .....	422-430
ρόδα pizza.....	408	σταχτοδοχείο πορσελάνης.....	8-121, 346	τυριέρα.....	315
ρόδες κοπής φύλλου.....	410	στίφτης φέτας λεμονιού.....	338	<b>φ</b>	
<b>σ</b>		στραγγιστήρας σαλάτας.....	463	φαγητοδοχείο.....	480-488
σακούλα ζαχαροπλαστικής.....	415	στυπτήριο .....	338	φιάλη για σάλτσες.....	468
σαλατιέρα γυάλινη.....	280-281	σύριγγα ζαχαροπλαστικής.....	419	φλιτζάνι πορσελάνης.....	8-121, 371
σαλατιέρα μελαμίνης.....	250-268	σύριγγα μαγειρικής.....	452	φλιτζάνι γυάλινο.....	372-373
σαλατιέρα πορσελάνης.....	8-121	σύρμα κοπής .....	419	φλιτζάνι ισοθερμικό .....	372-373
σαλτσιέρα inox.....	315	σφυρί πάγου.....	363	φλόγιστρο.....	414
σαλτσιέρα πορσελάνης.....	306	<b>τ</b>		φοντού.....	220
σαμπανιέρα .....	357-361	ταψί κουζίνας.....	394	φόρμα ζαχαροπλαστικής .....	427-431
σαχάνι.....	304-305	ταψί μαντεμένιο.....	223	φόρμα κρεμ-καραμελέ.....	427
σέικερ bar .....	332-334	ταψί μπουφέ .....	223	φόρμα σιλικόνης.....	432-439
σέικερ μπαχαρικών.....	374	ταψί πίτσας.....	409	φόρμα τάρτας.....	432-439
σέσουλα.....	398	ταψί πορσελάνης.....	212-214, 218-219	φρουτιέρα.....	241
σέσουλα πάγου .....	348	τεμαχιστής λαχανικών.....	463	φτυάρι πίτσας .....	406-407
σετ διακόσμησης bar.....	344	τεμαχιστής μήλου .....	463	<b>χ</b>	
σετ μπαρ.....	344	τεμαχιστής ντομάτας.....	461	χάρτινο καλαμάκι.....	355
σινουά.....	396	τζίγκερ bar (jigger).....	333-335	χαρτοπετυετοθήκη .....	315
σιφόν .....	339, 377	τηγάνι .....	385-392	χορτομπαχά.....	460
σκαμνί βαλιτσών .....	539	τηγάνι wok .....	305, 307, 383, 391, 392	χρονόμετρο.....	469
σκεύη induction.....	218-223, 382-392	τηγάνι κρέπας .....	389-391	χρωματιστοί δίσκοι κοπής .....	456-457
σκεύη stoneware.....	114-117	τηγάνι παέγια .....	392	χύτρα inox.....	384-388
σκεύη πορσελάνης.....	283-284	τίκι .....	350-354	κωνί.....	397
σκεύος mini.....	297-308	τριμπουσόν.....	342	<b>ψ</b>	
σκεύος ατμού.....	467	τραπέζι buffet-συνεδρίου .....	513-514	ψαλίδι κουζίνας.....	454
σκεύος μυδιών .....	308	τρίφτης μοσχοκάρυδου.....	465	ψαλίδι οστρακοειδών-γαρίδας .....	454
σκοουπ παγωτού (scoop).....	411	τρίφτης (παρμεζάνας κ.λπ.).....	465	ψαλίδι πουλερικών .....	454
σουπλά.....	317	τρόλεϊ banquet.....	500-501	ψιχουλοσυλλέκτης .....	314
σουρωτήρι bar.....	334-336	τρόλεϊ bar-ποτών-πούρων .....	327-328	ψυγείο πάγου.....	349
σουρωτήρι κουζίνας .....	396-397	τρόλεϊ GN .....	490	ψυκτική πλάκα.....	495-496
σουφλέ.....	285	τρόλεϊ room service.....	519	ψωμέρα .....	318-321
σπάτουλα άκαυστη.....	404	τρόλεϊ αποθήκης.....	477	<b>ω</b>	
σπάτουλα ζύμης.....	404	τρόλεϊ βαλιτσών.....	521-522, 528-529	wine coolers.....	362
σπάτουλα κέικ-τάρτας .....	405	τρόλεϊ γενικής χρήσης.....	329		
σπάτουλα κουζίνας .....	404-405	τρόλεϊ θερμαινόμενο πιάτων.....	491		
σπάτουλα παλέτα.....	405	τρόλεϊ ιματισμού-λινών.....	537		
σπάτουλα σερβιρίσματος.....	286	τρόλεϊ μεταφοράς άπλυτων .....	537		
		τρόλεϊ πιάτων .....	501		

Δημητρίου Γούναρη 38-40  
185 31, Πειραιάς, Αττική  
**Τηλ.: 210.41.00.444**  
**Fax: 210.41.00443**  
**e-mail: info@horeca.gr**

**[www.horeca.gr](http://www.horeca.gr)**

 [Horeca.gr](https://www.facebook.com/Horeca.gr)

 [horeca.gr\\_piraeus](https://www.instagram.com/horeca.gr_piraeus)